



**utp maintenance**  
by voestalpine

# Filler Metals for Repair, Hardfacing and Cladding Applications





# Filler Metals for Repair, Hardfacing and Cladding Applications

UTP Maintenance  
Global Brand Management  
T. +49 7633 409-01  
[utp.maintenance@voestalpine.com](mailto:utp.maintenance@voestalpine.com)

**voestalpine**  
ONE STEP AHEAD.



## Tailor-made Protectivity™

UTP Maintenance – provides lasting “protection” and “productivity” of the plant.  
“Protectivity” is the result of supporting our customers with maximum performance.

Decades of industry experience and application know-how in the areas of repair as well as wear and surface protection, combined with innovative and tailored products, guarantee the customers increased productivity and in addition protection and the highest performance of their components under the UTP Maintenance brand.

## Solutions for demanding industries

Products of UTP Maintenance are focused on industries with high technical requirements and specialized applications.

3

## Metallurgical know-how for research & development

International customers and distributors are supported by experienced welding engineers by voestalpine Böhler Welding.

In addition our ambition to be best in class motivates constant evolution through our total dedication to research and development and guarantees our customers are using the most technically advanced welding products available today.

The product portfolio of UTP Maintenance comprises of innovative and tailored welding consumables from own production facilities as follows ...

- Stick electrodes
- Solid wires and rods
- Flux cored wires
- Submerged arc wires and fluxes
- Submerged arc strips and fluxes
- Spraying- and PTA-powders

Our product range is comprehensive and covers the following steel alloys:

Unalloyed and fine-grained steels, Low-alloy steels, Stainless and heat-resistant steels, Nickel-base alloys, Cast-iron, Copper and Copper-base alloys, Manganese steels, Tool steels and Cobalt alloys.

## Böhler Welding know-how joins steel.

Customers in over 120 countries join the expertise of voestalpine Böhler Welding (formerly the Böhler Welding Group). Focused on filler metals voestalpine Böhler Welding offers extensive technical consultation and individual solutions for industrial welding and soldering applications. Customer proximity is guaranteed by 40 subsidiaries in 28 countries with the support of 2200 employees as well as through more than 1000 distribution partners world-wide.

### Three competencies – three brands

Joint Welding, Welding for Repair & Maintenance, and Brazing and Soldering. The proven products and solutions are combined under three brands in these three competency categories.



**Böhler Welding** – More than 2000 products for joint welding in all conventional arc welding processes are united in a product portfolio that is unique throughout the world. Creating lasting connections is the brands' philosophy for both, in welding and between people.



**UTP Maintenance** – Decades of industry experience and application know-how in the areas of repair as well as wear and surface protection, combined with innovative and tailored products, guarantee customers an increase in the productivity and protection of their components.



**Fontargen Brazing** – Through deep insight into processing methods and understand how to apply Fontargen Brazing provides the best brazing and soldering solutions. The expertise of this brand's application engineers has been formulated over many years of experience from countless application cases based on proven products with German technology.

[www.voestalpine.com/welding](http://www.voestalpine.com/welding)



## AEO-Certification



Customers of UTP Maintenance, with its headquarters in Bad Krozingen and Seneffe, can now enjoy an even more reliable supply chain and streamlined customs clearing.

With the award of the AEO-F certificate (Authorized Economic Operator), valid from December 27, 2012, the Bielefeld chief customs office has acknowledged Boehler Schweisstechnik Deutschland GmbH's secure and reliable handling of international trade. On January 7<sup>th</sup> 2010, the Belgian Administration of Customs and Excise (regional office of Mons), delivered Soudokay s.a., based in Seneffe (Belgium) the AEO-F certification (Authorized Economic Operator), certifying secure and reliable international companies.

AEO-F certification, and hence, the customs office's lower risk classification, mean our customers now benefit from accelerated and more reliable supply processes beyond the borders of the EU. AEO-F (full) status includes the status AEO-C (customs), which entails the simplification of customs regulations, as well as the security conditions of the AEO-S (security).

## We understand ...

In today's fast-moving and competition-defining world it is more important than ever before to have a partner by your side on which you can rely, who listens, understands the challenges and is ready to face them together with you.

In particular in the field of maintenance and repair we are almost always outside the standards and are continually faced with the most diverse requirements and tasks. It is therefore all the more important to have an extensive wealth of experience and a network of experienced colleagues in order to be able to face any challenge, any time.

## You can rely on us!

We offer you 60 years of experience, expertise and passion, combined with maximum quality. We demand no less than that of ourselves.

## We're there, wherever you need us!

With a worldwide network of technical employees and marketing companies as well as direct contact, we guarantee that we can always work out the best possible solution together with you.

6





## We face the challenges !

... **in steelworks** – welding on of continuous casting rollers where particularly high demands are placed on temperature and wear resistance with our specially conceived and proven flux-cored wires.

... **in the cement industry** – high mineral wear/abrasion combined with a heavy impact load. Our stick electrodes were developed especially for use on vertical mills, crushers & hammers.

... **in the mining industry** – the most diverse minerals present big challenges. Here in particular it is important to be present on-site by a network of technical dealers and field service employees in order to select the right products together with the customer.

... **in the railway industry** – our products have the necessary approvals and thus meet the highest safety requirements in addition to guaranteeing constant high quality.

... **in the construction of pumps, valves & fittings** – we have the largest team of international welding engineers in Europe who, thanks to their many years of experience are very familiar with different materials such as cobalt or nickel-based alloys. In particular in consideration of the environmental aspect is it of the utmost importance that valves, for example for subsea applications, work defect-free.

Maintenance and repair offers a broad field and a virtually inexhaustible range of applications, for example in the fields of recycling & waste management, agriculture & food, earth moving, pulp & paper, glass & tool construction.

**Please get in contact with us! Together we'll find a solution !**

# Product page structure

SMAW – covered electrodes	<b>UTP 613 Kb</b>	Unalloyed and low alloyed steels			
	<b>Classifications</b>	basic-coated stick electrode			
	EN ISO 2560-A	AWS A5.1			
	E 42 S B42 H5	– E 7018-1 H4 R			
	<b>Characteristics and field of use</b>				
	UTP 613 Kb is a basic-coated stick electrode for construction-, boiler-, tube- and fine-grained steels as well as for steels with up to 0.35% C-content. It is especially recommended for the base materials as mentioned below.				
	UTP 613 Kb has a good weldability and a stable arc. The weld metal is resistant to ageing, crack-resistant and is little affected by steel impurities.				
	<b>Base materials</b>				
	Construction steels	St 34 - St 60			
	Fine-grained-steels	St E 255 - 355			
	Boiler steels	H I - H II, 17 Mn 4			
	Tube steels	St 35 - St 55, St 35.8, St 45.8			
	Cast steels	GS 38 - GS 52			
	<b>Typical analysis in %</b>				
20	C	Si	Mn	Fe	
	0.07	0.4	1.1	balance	
<b>Mechanical properties of the weld metal</b>					
	Yield strength $R_{m0.2}$	Tensile strength $R_m$	Elongation $A$	Impact strength $K_{Ic}$	
	MPa	MPa	%	J	
	> 420	> 510	> 25	> 120	
<b>Welding instructions</b>					
Keep a short arc during the welding process. Weld dry stick electrodes only. Re-drying: 2 – 3h / 250 – 300°C. Preheat weldment if necessary					
<b>Welding positions</b>					
		Current type DC (+)			
<b>Approvals</b>					
TÜV (No. 00794), DB (No. 10.014.80), ABS, BV, DNV					
<b>Form of delivery and recommended welding parameters</b>					
	Electrodes $\emptyset$ mm x L	2.5 x 350	3.2 x 350	4.0 x 350	5.0 x 450
	Amperage	80 – 100	110 – 150	140 – 200	170 – 210

- ① **Product form** – Different product forms are marked in colour for easy selection
- ② **Product specification** – Type of alloy
- ③ **Covering type**  
Coating material for stick electrodes
- ④ **Product name** – Product designation
- ⑤ **Name of standard**  
EN ISO and AWS classification, material number if applicable
- ⑥ **Properties and application areas**  
Properties to be emphasised such as resistance to corrosion or redrying data and typical areas of application
- ⑦ **Base materials** – e.g. base materials whose suitability has been tested by TÜV
- ⑧ **Reference analysis of the weld metal**  
Chemical composition by weight %
- ⑨ **Mechanical properties of the weld metal**  
Min. values at a room temperature of 20°C
- ⑩ **Instructions for welding**
- ⑪ **Welding positions**
- ⑫ **Type of current and shielding gas**  
Recommended electrical polarity and shielding gas
- ⑬ **Approval** – Existing approvals
- ⑭ **Delivery units** – Product form giving length and diameter, electrical current data

# Signs and symbols

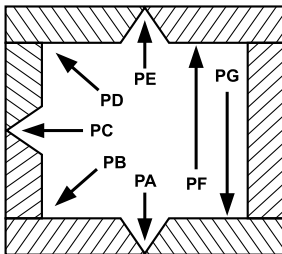
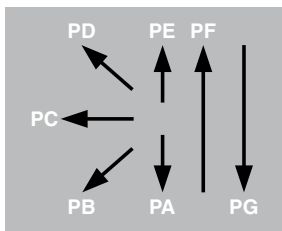

## Welding positions acc. to EN ISO 6947

- PA** Horizontal welding of butt weld and fillet weld in flat position
- PB** Horizontal welding of fillet weld (downhand position)
- PC** Transverse position
- PD** Horizontal overhead position
- PE** Overhead position
- PF** Vertical up position
- PG** Vertical down position



—> Welding position recommended

=> Welding position non-recommended

**SMAW – covered electrodes 16****Description of the SMAW process 17****Covered electrodes for repair of cracked material 18**

1. Unalloyed and low alloyed steels 18
2. Stainless steels 22
3. Nickel alloys 33
4. Cast iron 48
5. Copper alloys 55

**Surfacing electrodes for anti-wear and anti-corrosion applications 60****GTAW – TIG rods 92****Description of the GTAW process 93****TIG rods for repair of cracked material 94**

1. Unalloyed and low alloyed steels 94
2. Stainless steels 96
3. Nickel alloys 106
4. Cast iron 121
5. Copper alloys 123
6. Tool steels 133
7. Cobalt-based alloys 141

<b>GMAW – solid wires</b>	<b>146</b>
<b>Description of the GMAW process</b>	<b>147</b>
<b>Solid wires for repair of cracked material</b>	<b>148</b>
1. Unalloyed and low alloyed steels	148
2. Stainless steels	153
3. Nickel alloys	163
4. Cast iron	178
5. Copper alloys	180
<b>Surfacing solid wires for anti-wear and anti-corrosion applications</b>	<b>190</b>

<b>FCAW-G – gas-shielded cored wires</b>	<b>204</b>
<b>Description of the FCAW process</b>	<b>205</b>
<b>Flux-cored wires for repair of cracked material</b>	<b>206</b>
1. Unalloyed and low-alloyed steels	206
2. Stainless steels	208
<b>Gas-shielded cored wires for repair, anti-wear and anti-corrosion applications</b>	<b>222</b>
1. Manganese steels	222
2. Low-alloyed steels	226
3. High-alloyed steels	240
4. Tool steels	250
5. Cobalt alloys	268
6. Nickel alloys	280
7. Stainless steels	292
<b>Gas-shielded flux-cored wire</b>	<b>306</b>
1. Seamless flux-cored wires for automated welding	306

**FCAW-O – open arc cored wires 320****Description of the FCAW-O process 321****Open arc cored wires for repair, anti-wear and anti-corrosion applications 322**

1. Manganese steels 322
2. Unalloyed and low alloyed steels 330
3. High alloyed steels 346
4. Stainless steels 376

**SAW – solid wires and fluxes 388****Description of the SAW process 389****SAW wires and fluxes for anti-wear applications 390**

1. SAW wires 390
2. SAW fluxes 396

**SAW wires and fluxes for anti-corrosion applications 399**

1. SAW wires 399
2. SAW fluxes 403

<b>SAW – cored wires and fluxes</b>	<b>406</b>
<b>Submerged arc cored wires for anti-wear and anti-corrosion applications</b>	<b>408</b>
1. Manganese steels	408
2. Unalloyed and low-alloyed steels	412
3. High-alloyed steels	424
4. Tool steels	428
5. Stainless steels	432
<b>SAW product selection table</b>	<b>446</b>

<b>Cladding</b>	<b>450</b>
<b>Description of (SAW) submerged arc strip cladding</b>	<b>452</b>
<b>Description of (ESW) electro slag strip cladding</b>	<b>453</b>
<b>Strip cladding</b>	<b>454</b>
1. Unalloyed and low alloyed steels	454
2. Stainless steels hardfacing and buffering	458
3. Cobalt alloys	462
<b>Strip cladding equipment</b>	<b>464</b>
1. Strip cladding nozzles	464
2. Magnetic steering device	465

**Thermal spraying** **466****Description of the thermal spraying process** **467****Powders** **468**

1. SIMmelt™ – Powders for simultaneous meltdown 468

2. SUBmelt™ – Powders for subsequent melting 469

3. COLDmelt™ – Powders without melting (cold process) 470

**Description of the arc spraying with flux-cored wires process** **471****Cored wires** **472**

1. High alloyed steels 472

2. Nickel alloys 477

**Description of the plasma transferred arc process** **486****Powders** **487**

1. PLASweld™ – Powders for hard facing 487

**Special products** **488****Covered electrodes** **489**

1. Chamfering and gouging covered electrodes 489

2. Underwater repair electrode 489

**Gas rods** **493**

1. Covered electrodes for cutting and gouging 493

**Cored Wires** **498**

1. Cutting cored wire 498



<b>Appendix</b>	<b>500</b>
<b>Packaging information</b>	<b>501</b>
1. SMAW – covered electrodes	501
2. GTAW – TIG rods	502
3. GMAW – MIG wires	503
4. GMAW – flux cored wires	504
5. SAW – flux and wires	505
6. SAW – strips	508
<b>Diagrams</b>	<b>509</b>
1. Rocha intergranular corrosion diagram	509
2. Schaeffler diagram	509
3. DeLong diagram	510
4. WRC 92 diagram	510
<b>Guidelines for the storage and transport of cored welding wires for general applications</b>	<b>511</b>
<b>Guidelines for the storage and transport of solid welding wire and rods for general applications</b>	<b>512</b>
<b>Guidelines for the storage and rebaking of welding consumables for nuclear power plants and general applications</b>	<b>513</b>
<b>Material test certificates according to EN 10 204</b>	<b>516</b>
<b>Hardness conversion table</b>	<b>517</b>
<b>Metallography structures</b>	<b>519</b>
1. Austenitic	519
2. Martensitic	519
3. Complex carbide microstructure with austenitic or martensitic iron matrix	520
<b>Welding positions according to EN ISO 6947 und ASME code, section IX</b>	<b>521</b>
<b>Alphabetical product index</b>	<b>523</b>

## List of contents

### **SMAW – covered electrodes**

<b>Description of the SMAW process</b>	<b>17</b>
<b>Covered electrodes for repair of cracked material</b>	<b>18</b>
1. Unalloyed and low alloyed steels	18
2. Stainless steels	22
3. Nickel alloys	33
4. Cast iron	48
5. Copper alloys	55
<b>Surfacing electrodes for anti-wear and anti-corrosion applications</b>	<b>60</b>

## Description of the SMAW process

*SMAW = Shielded Metal-Arc Welding*

**Shielded metal-arc welding is one of the oldest and most versatile welding methods, and is considered to be both simple and reliable.**

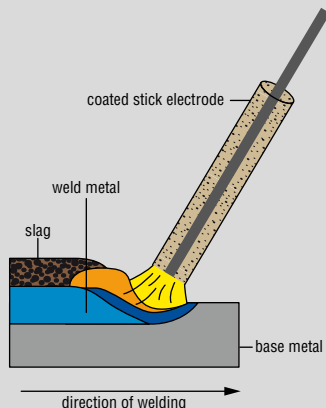

In this technique, an electric arc is struck between a covered electrode and the workpiece; the electrode acts both as the carrier of electric current and as the welding consumable that will be melted. The electrode is melted in the high temperature of the arc, and transfers to the weld pool in the form of drops. As this happens, gases that stabilise the arc and shield the weld pool from oxidation, and slag that floats on the weld pool as protective layer, are formed. This fulfils a number of functions: it protects both against the influence of the surrounding atmosphere (primarily oxidation), binds contamination, and reduces stresses by slowing the rate at which the weld pool cools down. A wide range of different electrodes for shielded metal-arc welding are available. Their alloying elements allow the strength and toughness of the weld seam to be accurately controlled. It is mainly used in steel construction and pipeline construction, as well as for work in the open air and on assembly jobs, since the necessary equipment is compact and can easily be transported.

## Covered electrodes for repair of cracked material

### 1. Unalloyed and low alloyed steels

Product name	EN ISO		AWS		Page
UTP 611	2560-A	E 38 0 RR 12	A5.1	~ E 6013	19
UTP 613 Kb	2560-A	E 42 5 B42 H5	A5.1	~ E 7018-1 H4 R	20
UTP 614 Kb	2560-A	E 42 3 B32 H10	A5.1	E 7018	21

#### Solution examples

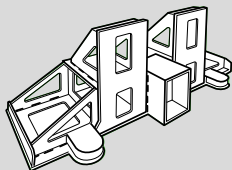

*Steel construction repair*

UTP 611

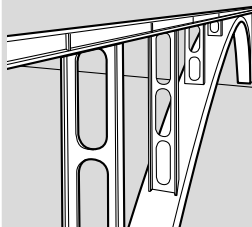

*Bridge construction repair*

UTP 614 Kb

**Classifications** rutile, thick-coated stick electrode, universally applicable

EN ISO 2560-A AWS A5.1

E 42 0 RR 12 E 6013

### Characteristics and field of use

UTP 611 is a thick-coated stick electrode for joining and surfacing on all kinds of mild steel constructions. It is used in automotive- and wagon industries, boiler construction and shipbuilding.

UTP 611 is easily weldable in all positions except for vertical down. It shows excellent welding properties: very easy slag removal and a smooth and finely-rippled weld seam surface. The stick electrode can be applied within a wide amperage range.

### Base materials

Construction steel	St 34 - St 52
Boiler steels	H I - H II, WStE 255, 17 Mn 4
Tube steels	St 35 , St 45, St 35.8, St 45.8, StE 210.7 - StE 360.7

### Typical analysis in %

C	Si	Mn	Fe
0.10	0.3	0.5	balance

### Mechanical properties of the weld metal

Yield strength $R_{p0.2}$	Tensile strength $R_m$	Elongation $A$	Impact strength $K_V$
MPa	MPa	%	J
> 420	> 510	> 17	> 47

### Welding instructions

UTP 611 is welded with a short to medium-long arc with slight weaving. The stick electrode should be held at an angle of approx. 75° to the plate. Re-drying: 2 – 3 h / 250 – 300 °C.

### Welding positions



Current type DC (-) / AC

### Approvals

TÜV (No. 02180), DB (No. 10.132.79), DNV GL

### Form of delivery and recommended welding parameters

Electrodes $\varnothing \times L$ [mm]	2.0 x 300	2.5 x 350	3.2 x 350	3.2 x 450	4.0 x 450	5.0 x 450
Amperage [A]	40 – 70	60 – 90	90 – 140	90 – 140	140 – 190	190 – 230

**UTP 613 Kb**

Unalloyed and low alloyed steels

**Classifications**

basic-coated stick electrode

EN ISO 2560-A

AWS A5.1

E 42 5 B42 H5

~ E 7018-1 H4 R

**Characteristics and field of use**

UTP 613 Kb is a basic-coated stick electrode for construction-, boiler-, tube- and fine-grained steels as well as for steels with up to 0.35 % C-content. It is especially recommended for the base materials as mentioned below.

UTP 613 Kb has a good weldability and a stable arc. The weld metal is resistant to ageing, crack-resistant and is little affected by steel impurities.

**Base materials**

Construction steels	St 34 - St 60
Fine-grained-steels	St E 255 – 355
Boiler steels	H I - H II, 17 Mn 4
Tube steels	St 35 - St 55, St 35.8, St 45.8
Cast steels	GS 38 - GS 52

**Typical analysis in %**

C	Si	Mn	Fe
0.07	0.4	1.1	balance

**Mechanical properties of the weld metal**

Yield strength $R_{p0.2}$	Tensile strength $R_m$	Elongation $A$	Impact strength $K_V$
MPa	MPa	%	J
> 420	> 510	> 25	> 120

**Welding instructions**

Keep a short arc during the welding process. Weld dry stick electrodes only.  
Re-drying: 2 – 3 h / 250 – 300 °C. Preheat weldment if necessary

**Welding positions**

Current type DC (+)

**Approvals**

TÜV (No. 00794), DB (No. 10.014.80), ABS, BV, DNV GL

**Form of delivery and recommended welding parameters**

Electrodes $\varnothing \times L$ [mm]	2.5 x 350	3.2 x 350	4.0 x 350	5.0 x 450
Amperage [A]	80 – 100	110 – 150	140 – 200	170 – 210

# UTP 614 Kb

Unalloyed and low alloyed steels

## Classifications

basic-coated stick electrode, AC-weldable

EN ISO 2560-A

AWS A5.1

E 42 3 B32 H10

E 7018

## Characteristics and field of use

UTP 614 Kb is a double coated stick electrode with a universally suited application field. It is used in industry, trade, as well as in production and repair welds for diverse base materials.

Due to a special coating formula UTP 614 Kb shows a smooth and finely rippled weld seam, a stable arc, easy slag removal, and a very slight increase of the weld, as well as a notch-free seam. The weld metal is little affected by steel impurities. Due to the double coating the stick electrode is excellently suited for root- and out-of-position welding. Recovery 120%, H<sub>2</sub> content < 8 ml / 100g.

## Base materials

Unalloyed construction steels	S235JRG2 – S355J2; E295, E335, St35, St 45, St 35.8, St45.8, St50-2
Boiler steels	P235GH, P265GH, P295GH
Fine-grained	steels up to S355N
Shipbuilding	steels A – E, AH - EH
Cast steels	C 35, GS-38, GS-45

## Typical analysis in %

C	Si	Mn	Fe
0.06	0.7	0.9	balance

## Mechanical properties of the weld metal

Yield strength $R_{p0.2}$	Tensile strength $R_m$	Elongation A	Impact strength $K_V$	
MPa	MPa	%	J	- 30 °C
> 420	> 510	> 22	>100	> 47

## Welding instructions

Ignite the electrode and stay at the ignition point until the electric arc is fully stabilised. Keep a short arc during the welding process. Hold stick electrode vertical to the weldment with slight weaving. Re-drying: 2 – 3 h / 250 – 300 °C. Only use dry stick electrodes

## Welding positions



Current type DC (+) / AC

## Approvals

TÜV (No. 10571), DB (No. 10.138.03), BV, DNV GL, ABS, LR

## Form of delivery and recommended welding parameters

Electrodes $\varnothing \times L$ [mm]	2.5 x 350	3.2 x 350	3.2 x 450	4.0 x 450	5.0 x 450
Amperage [A]	60 – 90	100 – 140	100 – 140	140 – 180	190 – 250

## Covered electrodes for repair of cracked material

### 2. Stainless steels

Product name	EN ISO	AWS	Mat.-No.	Page
UTP 63	3581-A E 18 8 Mn R 32		1.4370	23
UTP 65	3581-A		~1.4337	24
UTP 65 D	3581-A ~E 29 9 R 12		1.4337	25
UTP 68	3581-A E 19 9 Nb R 32	A5.4 E 347-17	1.4551	26
UTP 68 H	3581-A E 25 20 R 32	A5.4 E 310-16	1.4842	27
UTP 68 LC	3581-A E 19 9 L R 32	A5.4 E 308 L-17	1.4316	28
UTP 68 Mo	3581-A E 19 12 3 Nb R 32	A5.4 E 318-16	1.4576	29
UTP 68 MoLC	3581-A E 19 12 3 L R 32	A5.4 E 316 L-17	1.4430	30
UTP 6635	3581-A E 13 4 B 42	A5.4 E 410 NiMo	1.4351	31
UTP 6824 LC	3581-A E 23 12 L R 32	A5.4 E 309L-17	~1.4332	32

#### Solution examples

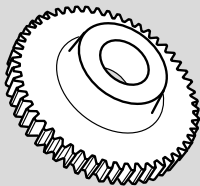

*Gear wheel*

UTP 65 D

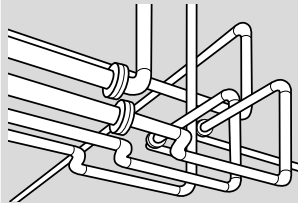

*Piping*

UTP 63

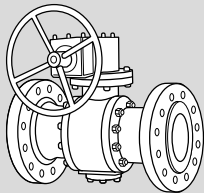

*Valve*

UTP 68 H

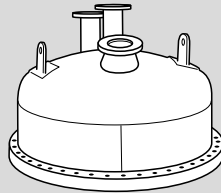

*Pressure vessel*

UTP 68 LC



**Classifications** rutile-coated, fully austenitic CrNiMnstick electrode

EN ISO 3581-A	EN 14700	Material-No
E 18 8 Mn R 32	E Fe10	1.4370

### Characteristics and field of use

With the fully austenitic UTP 63, non-alloy structural and heat-treatable steels can be welded, also in combination with austenitic CrNi steels. Furthermore scale-resisting steels for operating temperatures up to 850 °C as well as higher carbon materials and high manganese steel can be joined, also in combination with other steels, with UTP 63. For surfacing on workpieces exposed to impact, pressure and rolling wear, such as curved rails, points, crusher and excavator teeth. Moreover it provides crack-proof buffer layers under hard alloys.

UTP 63 has good welding properties, stable arc, finely rippled bead appearance. The weld deposit resists to scaling, rust and cracks, work-hardened.

Hardness of the pure weld metal  
 untreated: approx. 200 HB  
 work-hardened: approx. 350 HB

### Typical analysis in %

C	Si	Mn	Cr	Ni	Fe
0.1	0.5	5.5	19.0	8.5	balance

### Mechanical properties of the weld metal

Yield strength $R_{p0.2}$	Tensile strength $R_m$	Elongation A	Impact strength $K_V$
MPa	MPa	%	J
> 350	> 600	> 40	> 60

### Welding instructions

Clean welding area thoroughly. Pre-heating of thick-walled ferritic parts to 150 – 250 °C. Hold stick electrode vertically with a short arc. Re-dry stick electrodes that have got damp for 2 h / 250 – 300 °C.

### Welding positions

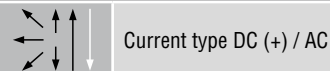

### Form of delivery and recommended welding parameters

Electrodes $\varnothing \times L$ [mm]	2.5 x 250	3.2 x 350	4.0 x 400	5.0 x 450
Amperage [A]	50 – 70	70 – 100	100 – 130	150 – 180

## UTP 65

stainless steels

**Classifications** rutile-coated austenitic-ferritic special stick electrode

EN ISO 3581-A

EN 14700

Material-No.

~ E 29 9 R 32

E Z Fe11

~ 1.4337

**Characteristics and field of use**

UTP 65 is particularly suitable for joinings on hardly weldable steels, when highest demands on the welding seam are made. High crack resistance when joining parent metals of difficult weldability, such as austenitic and ferritic steels, high-manganese steels with alloyed and non-alloyed steels, heat-treatable and tool steels. As cushion layer on these materials it is also ideally suited. UTP 65 finds a variety of applications in the repair and maintenance of machine and drive components as well as in tool repairing.

UTP 65 is very easily weldable with a smooth and stable arc, homogeneous, finely rippled bead appearance and gives very good slag removal, self-lifting in parts. The austenitic-ferritic weld deposit has highest strength values and high crack resistance. Workhardening, creep resistant and stainless.

Hardness of the pure weld metal: approx. 240 HB

**Typical analysis in %**

C	Si	Mn	Cr	Ni	Fe
0.1	1.0	1.0	29.0	9.0	balance

**Mechanical properties of the weld metal**

Yield strength $R_{p0.2}$	Tensile strength $R_m$	Elongation $A$
MPa	MPa	%
> 620	> 800	> 22

**Welding instructions**

Clean welding area thoroughly. Pre-heating of thick-walled ferritic parts to 150 – 250 °C. Keep the arc short up to medium-long. Apply string beads with little weaving. Hold stick electrode as vertically as possible. Redry stick electrodes that have got damp for 2 h / 120 – 200 °C.

**Welding positions**

Current type DC (+) / AC

**Approvals**

DB (No. 82.138.01)

**Form of delivery and recommended welding parameters**

Electrodes $\varnothing \times L$ [mm]	1.6 x 250*	2.0 x 250	2.5 x 250	3.2 x 350	4.0 x 350	5.0 x 350
Amperage [A]	35 – 50	45 – 65	60 – 80	80 – 130	100 – 150	120 – 200

\*available on request

**Classifications** rutile-coated austenitic-ferritic special stick electrode

EN ISO 3581-A	EN 14700	Material-No.
~ E 29 9 R 12	E Z Fe11	1.4337

**Characteristics and field of use**

UTP 65 D has been developed to meet the highest requirements for repair and surfacing. It is extremely crack-resistant when joining steels of difficult weldability, such as e. g. hard manganese steels, tool steels, spring steels, high speed steels as well as dissimilar metal joints. Due to the good corrosion and abrasion resistance and high tensile strength UTP 65 D finds its application particularly in repair and maintenance of machine and drive components, such as gears, cams, shafts, hot cuts, hot trim plates and dies. Also ideally suited as an elastic cushioning layer for very hard surfacing.

UTP 65 D has outstanding welding properties. Stable arc, spatter-free. The finely rippled seam has a homogeneous structure, very good slag removal, self-lifting on parts. Good weldability in awkward positions. Stainless, creep resistant and work-hardening.

Hardness of the pure weld metal: approx. 260 HB

**Typical analysis in %**

C	Si	Mn	Cr	Ni	Fe
0.1	1.0	1.0	30.0	9.5	balance

**Mechanical properties of the weld metal**

<i>Yield strength Rp0.2</i>	<i>Tensile strength R<sub>m</sub></i>	<i>Elongation A</i>
<i>MPa</i>	<i>MPa</i>	<i>%</i>
> 640	> 800	> 20

**Welding instructions**

Clean the welding zone thoroughly. Prepare X-, V- or U-groove on thick-walled workpieces with an angle of 60 – 80 °. Preheat high-C-containing steels and solid workpieces to approx. 250 °C. Hold stick electrode vertically and weld with a short arc, use stringer beads or slight weaving, as applicable. Re-dry damp stick electrodes for 2 h / 120 – 200 °C.

**Welding positions**

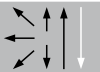

Current type DC (+) / AC

**Form of delivery and recommended welding parameters**

<i>Electrodes Ø x L [mm]</i>	1.6 x 250*	2.0 x 250	2.5 x 250	3.2 x 350	4.0 x 350	5.0 x 350
<i>Amperage [A]</i>	35 – 45	45 – 60	55 – 75	75 – 115	100 – 145	120 – 195

\*available on request

## UTP 68

stainless steels

## Classifications

stabilized stick electrode

EN ISO 3581-A

AWS A5.4

Material-No.

E 19 9 Nb R 3 2

E 347-17

1.4551

## Characteristics and field of use

The rutile-coated welding stick electrode UTP 68 is suitable for joining and surfacing of stabilized and non stabilized CrNi steels and CrNi cast steels. The deposit is IC resistant with stabilized base material up to + 400 °C working temperature. The stick electrode is also applicable for the 2nd layer on clad CrNi steels.

The stick electrode is weldable in all positions except vertical down. It has a stable arc and is spatter free. Easy ignition and re-ignition, self detaching slag. Clean and finely rippled bead without undercutting.

## Base materials

1.4301, 1.4312, 1.4541, 1.4550, 1.4552

## Typical analysis in %

C	Si	Mn	Cr	Ni	Nb	Fe
0.03	0.8	0.5	19.0	10.0	0.25	balance

## Mechanical properties of the weld metal

Yield strength $R_{p0.2}$	Tensile strength $R_m$	Elongation $A$	Impact strength $K_V$
MPa	MPa	%	J
> 380	> 590	> 30	> 47

## Welding instructions

Weld stick electrode slightly inclined with a short arc. Re-drying 2 h / 120 – 200 °C.

## Welding positions



Current type DC (+) / AC

## Approvals

TÜV (No. 02592), ABS, GL

## Form of delivery and recommended welding parameters

Electrodes $\varnothing \times L$ [mm]	2.0 x 300	2.5 x 350	3.2 x 350	4.0 x 350
Amperage [A]	40 – 60	50 – 90	80 – 110	110 – 140

## Classifications

fully austenitic CrNi stick electrode

EN ISO 3581-A

AWS A5.4

Material-No.

E 25 20 R 32

E 310-16

1.4842

## Characteristics and field of use

The rutile-coated stick electrode UTP 68 H is suitable for joining and surfacing of heat resistant Cr-, CrSi-, CrAl-, CrNi-steels / cast steels. It is used for operating temperatures up to 1100 °C in low-sulphur combustion gas. Application fields are in the engineering of furnaces, pipework and fittings.

UTP 68 H is weldable in all positions except vertical down. Fine droplet. The surface of the seams is smooth and finely rippled. Easy slag removal free from residues.

## Base materials

Material-No.	DIN	Material-No.	DIN
1.4710	G-X30 CrSi 6	1.4837	G- X40 CrNiSi 25 12
1.4713	X10 CrAl 7	1.4840	G- X15 CrNi 25 20
1.4762	X10 CrAl 24	1.4841	X15 CrNiSi 25 20
1.4828	X15 CrNiSi 20 12	1.4845	X12 CrNi 25 21
1.4832	G-X25 CrNiSi 20 14	1.4848	G- X40 CrNiSi 25 20

Joining these materials with non- and low alloyed steels is possible.

## Typical analysis in %

C	Si	Mn	Cr	Ni	Fe
0.10	0.6	1.5	25.0	20.0	balance

## Mechanical properties of the weld metal

Yield strength $R_{p0.2}$	Tensile strength $R_m$	Elongation $A$	Impact strength $K_V$
MPa	MPa	%	J
> 350	> 550	> 30	> 47

## Welding instructions

Weld stick electrode with slight tilt and with a short arc. Re-dry the stick electrodes 2 h / 120 – 200 °C.

## Welding positions



Current type DC (+) / AC

## Form of delivery and recommended welding parameters

Electrodes $\varnothing \times L$ [mm]	1.5 x 250*	2.0 x 250*	2.5 x 250	3.2 x 350	4.0 x 400
Amperage [A]	25 – 40	40 – 60	50 – 80	80 – 110	130 – 140

\*available on request

## UTP 68 LC

stainless steels

## Classifications

low-carbon stick electrode

EN ISO 3581-A

AWS A5.4

Material-No.

E 19 9 L R 3 2

E 308 L-17

1.4316

## Characteristics and field of use

The rutile-coated stick electrode UTP 68 LC, with a low-carbon content, is used for joining and building up of identical low-carbon, austenitic CrNi steels and CrNi cast steels. Due to the low C-content the deposit is highly resistant to intercrystalline corrosion and can be used for working temperatures up to +350 °C.

The stick electrode is weldable in all positions except vertical down. It has a smooth drop transfer and the deposit is finely rippled and without undercut. Slag removal is easy and without residues.

## Base materials

1.4301, 1.4306, 1.4311, 1.4312, 1.4541

## Typical analysis in %

C	Si	Mn	Cr	Ni	Fe
0.025	0.8	0.5	19.0	10.0	balance

## Mechanical properties of the weld metal

Yield strength $R_{p0.2}$	Tensile strength $R_m$	Elongation $A$	Impact strength $K_V$
MPa	MPa	%	J
> 350	> 520	> 35	> 47

## Welding instructions

The stick electrode should be welded slightly inclined and with a short arc. Re-drying 2 h / 120 – 200 °C.

## Welding positions



Current type DC (+) / AC

## Approvals

TÜV (No. 00100), ABS, GL

## Form of delivery and recommended welding parameters

Electrodes $\varnothing \times L$ [mm]	2.0 x 300	2.5 x 350	3.2 x 350	4.0 x 350	5.0 x 450
Amperage [A]	40 – 60	50 – 90	80 – 120	110 – 160	140 – 200

## Classifications

stabilized stick electrode

EN ISO 3581-A

AWS A5.4

Material-No.

E 19 12 3 Nb R 3 2

E 318 – 16

1.4576

## Characteristics and field of use

The rutile-coated stick electrode UTP 68 Mo is used for joining and surfacing of stabilized and non stabilized CrNiMo steels and CrNiMo cast steels. The deposit is IC resistant with stabilized base material up to +400 °C working temperature.

The stick electrode is weldable in all positions except vertical down. Even flow, very easy slag removal. Smooth, notch-free seam surface.

## Base materials

1.4401, 1.4404, 1.4408, 1.4436, 1.4571, 1.4580, 1.4581, 1.4583

## Typical analysis in %

C	Si	Mn	Cr	Mo	Ni	Nb	Fe
0.025	0.8	0.6	18.0	2.7	12.0	0.25	balance

## Mechanical properties of the weld metal

Yield strength $R_{p0.2}$	Tensile strength $R_m$	Elongation $A$	Impact strength $K_V$
MPa	MPa	%	J
380	560	30	55

## Welding instructions

Clean the weld zone and above all degrease it. Keep a short arc. Weld with dry stick electrodes. Re-dry for 2 h / 120 – 200 °C.

## Welding positions



Current type DC (+) / AC

## Approvals

TÜV (No. 02593)

## Form of delivery and recommended welding parameters

Electrodes $\varnothing \times L$ [mm]	1.5 x 250	2.0 x 300	2.5 x 350	3.2 x 350	4.0 x 350	5.0 x 450
Amperage [A]	25 – 40	40 – 60	50 – 90	80 – 120	120 – 160	140 – 200

## UTP 68 MoLC

stainless steels

## Classifications

low-carbon stick electrode

EN ISO 3581-A

AWS A5.4

Material-No.

E 19 12 3 L R 3 2

E 316 L-17

1.4430

## Characteristics and field of use

The rutile-coated stick electrode UTP 68 MoLC, with a low C-content, is used for joining and surfacing of identical, low-carbon, austenitic CrNiMo steels and CrNiMo cast steels. The weld deposit yields, thanks to the low C-content, a high resistance to intercrystalline corrosion and can be used for working temperatures up to +400 °C.

The stick electrode is weldable in all positions except vertical down. The weld deposit is smooth and finely rippled. Very easy slag removal without residues.

## Base materials

1.4401, 1.4404, 1.4436, 1.4571, 1.4573, 1.4580, 1.4583

## Typical analysis in %

C	Si	Mn	Cr	Ni	Mo	Fe
0.025	0.8	0.5	18.0	12.0	2.8	balance

## Mechanical properties of the weld metal

Yield strength $R_{p0.2}$	Tensile strength $R_m$	Elongation $A$	Impact strength $K_v$
MPa	MPa	%	J
380	560	30	60

## Welding instructions

The stick electrode should be welded slightly inclined and with a short arc. Re-drying 2 h / 120 – 200 °C.

## Welding positions



Current type DC (+) / AC

## Approvals

TÜV (No. 00101), ABS, DB (No. 30.014.35), DNV GL

## Form of delivery and recommended welding parameters

Electrodes $\varnothing \times L$ [mm]	1.5 x 250	2.0 x 300	2.5 x 350	3.2 x 350	4.0 x 350	5.0 x 450
Amperage [A]	25 – 40	40 – 60	50 – 90	80 – 120	120 – 160	140 – 200



<b>Classifications</b>		basic-coated stick electrode
EN ISO 3581-A	AWS A5.4	Material-No.
E 13 4 B 4 2	E 410 NiMo	1.4351

**Characteristics and field of use**

UTP 6635 is a basic-coated stick electrode for joinings and surfacings on corrosion resistant martensitic CrNi-steels and corresponding cast steels. The application field is in the armatures- and power station construction. The weld deposit has an increased resistance to cavitation and erosion also at working temperatures up to 350 °C.

UTP 6635 is weldable in all positions, except vertical-down. Easy slag removal, smooth and notch-free welding surface. Recovery: 130 %.

**Base materials**

1.4313, 1.4407, 1.4413, 1.4414

**Typical analysis in %**

C	Si	Mn	Cr	Ni	Mo	Fe
0.03	0.25	0.8	13.0	4.0	0.45	balance

**Mechanical properties of the weld metal**

Yield strength $R_{p0.2}$	Tensile strength $R_m$	Elongation A	Impact strength $K_V$
MPa	MPa	%	J
650	760	15	55

**Welding instructions**

Weld stick electrode slightly inclined with a short arc. For a wall thickness > 10 mm, a preheating of max. 150 °C is recommended. Re-drying 2 – 3 h / 250 – 350 °C.

**Welding positions**

Current type DC (+)

**Approvals**

TÜV (No. 05067)

**Form of delivery and recommended welding parameters**

Electrodes $\varnothing \times L$ [mm]	2.5 x 350	3.2 x 350	4.0 x 450	5.0 x 450
Amperage [A]	60 – 80	70 – 100	110 – 160	150 – 190

## UTP 6824 LC

stainless steels

## Classifications

low-carbon CrNi-stick electrode

EN ISO 3581-A

AWS A5.4

Material-No.

E 23 12 L R 32

E 309 L-17

~ 1.4332

## Characteristics and field of use

The rutile-coated stick electrode UTP 6824 LC is used for joining and surfacing of stainless and heat resistant steels / cast steels as well as for dissimilar metal joints (heterogeneous joints) and for buffer layers on corrosion - or wear resistant claddings on C-steels. The weld deposit is scale resistant up to + 1000 °C.

The stick electrode is weldable in all positions except vertical-down. It is distinguished by a stable arc, minimal spatter, and very good slag removal. The weld seam is regularly marked and free of pores.

## Base materials

1.4541, 1.4550, 1.4583, 1.4712, 1.4724, 1.4742, 1.4825, 1.4826, 1.4828  
Joining these materials with unalloyed and low-alloyed steels is possible.

## Typical analysis in %

C	Si	Mn	Cr	Ni	Fe
0.025	0.8	0.8	22.5	12.5	balance

## Mechanical properties of the weld metal

Yield strength $R_{p0.2}$	Tensile strength $R_m$	Elongation A	Impact strength $K_V$
MPa	MPa	%	J
> 390	> 550	> 30	> 47

## Welding instructions

Weld the stick electrode slightly inclined with a short arc. For claddings, the pre-heating and interpass temperature should be adjusted according to the base material. Re-drying 2 h / 120 – 200 °C.

## Welding positions



Current type DC (+) / AC

## Approvals

TÜV (No. 04074), DNV GL

## Form of delivery and recommended welding parameters

Electrodes $\varnothing \times L$ [mm]	2.5 x 350	3.2 x 350	4.0 x 450	5.0 x 450*
Amperage [A]	60 – 80	80 – 110	110 – 140	140 – 180

\*available on request

# Covered electrodes for repair of cracked material

## 3. Nickel alloys

Product name	EN ISO	AWS	Mat.-No.	Page
UTP 80 M	14172	E Ni 4060 (NiCu30Mn3Ti)	A5.11 E NiCu-7	2.4366 34
UTP 80 Ni	14172	E Ni 2061 (NiTi3)	A5.11 E Ni-1	2.4156 35
UTP 068 HH	14172	E Ni 6082 (NiCr20Mn3Nb)	A5.11 E NiCrFe-3 (mod.)	2.4648 36
UTP 759 Kb	14172	E Ni 6059 (NiCr23Mo16)	A5.11 E NiCrMo-13	2.4609 37
UTP 776 Kb	14172	E Ni 6276 (NiCr15Mo15Fe6W4)	A5.11 E NiCrMo-4	2.4887 38
UTP 2133 Mn	3581-A	EZ 2133 B42		~ 1.4850 39
UTP 2535 Nb	3581-A	EZ 2535 Nb B62		1.4853 40
UTP 3545 Nb	14172	E Ni Z 6701 (NiCr35Fe15Nb0.8)		41
UTP 4225	14172	E Ni 8165 (NiCr25Fe30Mo)		2.4652 42
UTP 6170 Co	14172	E Ni 6117 (NiCr22Co12Mo)	A5.11 E NiCrCoMo-1 (mod.)	2.4628 43
UTP 6222 Mo	14172	E Ni 6625 (NiCr22Mo9Nb)	A5.11 E NiCrMo-3	2.4621 44
UTP 6225 Al	14172	E Ni 6704 (NiCr25F10Al3YC)	A5.11 E NiCrFe-12	2.4649 45
UTP 7015	14172	E Ni 6182 (NiCr15Fe6Mn)	A5.11 E NiCrFe-3	2.4807 46
UTP 7015 Mo	14172	E Ni 6093 (NiCr15Fe8NbMo)	A5.11 E NiCrFe-2	47

### Solution examples

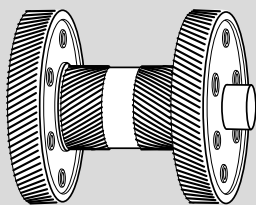

*Gear wheel*

UTP 068 HH

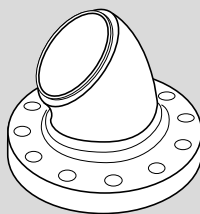

*Flange*

UTP 80 M

## UTP 80 M

nickel alloys

## Classifications

basic-coated nickel-copper stick electrode

EN ISO 14172

AWS A5.11

Material-No.

E Ni 4060 (NiCu30Mn3Ti)

E NiCu-7

2.4366

## Characteristics and field of use

UTP 80 M is suitable for joining and surfacing of nickel-copper alloys and of nickel-copper-clad steels. Particularly suited for the following materials: 2.4360 NiCu30Fe, 2.4375 NiCu30Al. UTP 80 M is also used for joining different materials, such as steel to copper and copper alloys, steel to nickel-copper alloys. These materials are employed in high-grade apparatus construction, primarily for the chemical and petrochemical industries. A special application field is the fabrication of seawater evaporation plants and marine equipment.

UTP 80 M is weldable in all positions, except vertical-down. Smooth, stable arc. The slag is easily removed, the seam surface is smooth. The weld metal withstands sea water.

## Typical analysis in %

C	Si	Mn	Ni	Cu	Ti	Al	Fe
< 0.05	0.7	3.0	balance	29.0	0.7	0.3	1.0

## Mechanical properties of the weld metal

Yield strength $R_{p0.2}$	Tensile strength $R_m$	Elongation $A$	Impact strength $K_V$
MPa	MPa	%	J
> 300	> 480	> 30	> 80

## Welding instructions

Thorough cleaning of the weld zone is essential to avoid porosity. V angle of seam about 70°, weld string beads if possible.

Weld with dry stick electrodes only! Re-dry stick electrodes 2 – 3 h / 200°C.

## Welding positions



Current type DC (+)

## Approvals

TÜV (No. 00248), ABS, GL

## Form of delivery and recommended welding parameters

Electrodes $\varnothing \times L$ [mm]	2.5 x 300	3.2 x 350	4.0 x 350	5.0 x 400
Amperage [A]	55 – 70	75 – 110	90 – 130	135 – 160

## Classifications

basic-coated pure nickel stick electrode

EN ISO 14172

AWS A5.11

Material-No.

E Ni 2061 (NiTi3)

E Ni-1

2.4156

## Characteristics and field of use

UTP 80 Ni is suited for joining and surfacing on commercial pure nickel grades, including LC nickel, nickel alloys and nickel-clad steels. These materials are employed primarily in the construction of pressure vessels and apparatus in the chemical industry, in the food industry and for power generation, where good behaviour under corrosion and temperature is demanded.

UTP 80 Ni is weldable in all positions, except vertical-down, and gives smooth, notch-free seams.

## Typical analysis in %

C	Si	Mn	Ni	Ti	Al	Fe
< 0.02	0.8	0.25	balance	2.0	0.2	0.1

## Mechanical properties of the weld metal

Yield strength $R_{p0.2}$	Tensile strength $R_m$	Elongation $A$	Impact strength $K_V$
MPa	MPa	%	J
> 300	> 450	> 30	> 160

## Welding instructions

Weld with dry stick electrodes only! Prior to welding the stick electrodes must be dried 2 – 3 h / 250 – 300 °C. Clean the weld zone thoroughly. The V angle of the seam should not be less than 70 °. Weld with short arc, avoiding weaving as much as possible.

## Welding positions

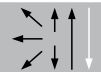

Current type DC (+)

## Approvals

TÜV (No. 00190)

## Form of delivery and recommended welding parameters

Electrodes $\varnothing \times L$ [mm]	2.5 x 300*	3.2 x 300	4.0 x 350
Amperage [A]	60 – 85	90 – 130	110 – 150

\*available on request

## UTP 068 HH

nickel alloys

## Classifications

basic-coated NiCrFe stick electrode

EN ISO 14172

AWS A5.11

Material-No.

E Ni 6082 (NiCr20Mn3Nb)

E NiCrFe-3 (mod.)

2.4648

## Characteristics and field of use

UTP 068 HH is predominantly used for joining identical or similar heat-resistant Ni-base alloys, heat-resistant austenites, such as 2.4817 (LC NiCr15Fe), 1.4876 (X10 NiCrTiAl 32 20), 1.4941 (X8 CrNTi 18 10). Specially used for joining of high carbon containing 25 / 35 CrNi cast steel to 1.4859 or 1.4876 for petrochemical installations with working temperatures up to 900 °C.

Furthermore UTP 068 HH can be used for repair welding of hardly weldable steels such as heat-treatable steels or tool steels. Additionally mixed joints of austenitic and ferritic materials with elevated service temperatures can be welded.

The welding deposit of UTP 068 HH is hot-cracking-resistant, does not tend to embrittle and is scale-resistant at high temperatures.

## Typical analysis in %

C	Si	Mn	Cr	Mo	Nb	Ni	Fe
0.025	0.4	5.0	19.0	1.5	2.2	balance	3.0

## Mechanical properties of the weld metal

Heat-treatment	Yield strength	Tensile strength	Elongation	Impact strength $K_V$	
	$R_{p0.2}$	$R_m$	A	J	- 196 °C
	MPa	MPa	%		
As welded	420	680	40	120	80
15 h 650 °C / air				120	70

## Welding instructions

Hold stick electrode as vertically as possible, only very little weaving. Fill end crater carefully. Interpass temperature max. 150 °C. Re-dry electrode for 2 – 3 h / 250 – 300 °C.

## Welding positions



Current type DC (+)

## Approvals

TÜV (No. 00230), KTA, ABS, BV, DNV GL

## Form of delivery and recommended welding parameters

Electrodes $\varnothing \times L$ [mm]	2.0 x 250	2.5 x 300	3.2 x 300	4.0 x 350	5.0 x 400
Amperage [A]	35 – 50	50 – 70	70 – 95	90 – 120	120 – 160

## Classifications

basic-coated NiCrMo stick electrode

EN ISO 14172

AWS A5.11

Material-No.

E Ni 6059 (NiCr23Mo16)

E NiCrMo-13

2.4609

## Characteristics and field of use

UTP 759 Kb is employed primarily for welding components in environmental plants and plants for chemical processes with highly corrosive media. Joint welding of matching base materials as Material-No. 2.4605 or similar matching materials as material No 2.4602 NiCr-21Mo14W. Joint welding of these materials with low-alloyed steels. Cladding on low-alloyed steels.

In addition to its good resistance to contaminated oxidating mineral acids, acetic acids and acetic anhydrides, hot contaminated sulphuric – and phosphoric acid, UTP 759 Kb has an excellent resistance against pitting and crevice corrosion. The special composition of the coating extensively prevents the precipitation of intermetallic phases.

UTP 759 Kb can be welded in all positions except vertical down. Stable arc, easy slag removal.

## Typical analysis in %

C	Si	Mn	Cr	Mo	Ni	Fe
< 0.02	< 0.2	0.5	22.5	15.5	balance	1.0

## Mechanical properties of the weld metal

Yield strength $R_{p0.2}$	Tensile strength $R_m$	Elongation $A$	Impact strength $K_V$
MPa	MPa	%	J
> 450	> 720	> 30	> 60

## Welding instructions

Opening angle of the prepared seam approx. 70°C, root gap approx. 2 mm. Weld stick electrode with slight tilt and with a short arc. String beads are welded. The interpass temperature of 150°C and a max. weaving width 2.5 x diameter of the stick electrode core wire should not be exceeded. Re-dry the stick electrodes 2 – 3 h / 150 – 300°C before use and weld them out of a warm stick electrode carrier.

## Welding positions

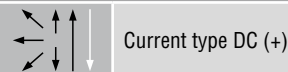

## Approvals

TÜV (No. 06687)

## Form of delivery and recommended welding parameters

Electrodes $\varnothing \times L$ [mm]	2.5 x 250	3.2 x 300	4.0 x 350
Amperage [A]	50 – 70	70 – 100	90 – 130

# UTP 776 Kb

## Classifications

covered electrode

EN ISO 14172

AWS A5.11

Material-No.

E Ni 6276 (NiCr15Mo15Fe6W4)

E NiCrMo-4

2.4887

## Characteristics and field of use

Joint welding of matching base materials, as Material-No. 2.4819 (NiMo16Cr15W) and surfacing on low-alloyed steels. It is employed primarily for welding components in plants for chemical processes with highly corrosive media, but also for surfacing press tools, punches etc. which operate at high temperatures.

In addition to its exceptional resistance to contaminated mineral acids, chlorine-contaminated media, and chloride containing media, it resists strong oxidisers such as ferric and cupric chlorides and is one of the few materials which will resist wet chlorine gas.

The stick electrode can be welded in all positions except vertical-down. Stable arc, easy slag removal.

## Typical analysis in %

C	Si	Mn	Cr	Mo	Ni	W	Fe
< 0.02	< 0.2	0.6	16.5	16.5	balance	4.0	5.0

## Mechanical properties of the weld metal

Yield strength $R_{p0.2}$	Tensile strength $R_m$	Elongation $A$	Impact strength $K_V$
MPa	MPa	%	J
> 450	> 720	> 30	> 70

## Welding instructions

For avoidance of intermetallic precipitation the stick electrode should be welded with lowest possible heat input and minimum interpass temperature. Beam width of the prepared seam approx. 70 °, root gap approx. 2 mm. Weld stick electrode with slight tilt and with a short arc. String beads are welded. The interpass temperature of 150 °C and a max. weaving width 2.5 x diameter of the stick electrode core wire should not be exceeded. Re-dry the stick electrodes 2 – 3 h / 250 – 300 °C before use and weld them out of a warm stick electrode carrier.

## Welding positions



Current type DC (+)

## Approvals

TÜV (No. 05257)

## Form of delivery and recommended welding parameters

Electrodes $\varnothing \times L$ [mm]	2.5 x 250	3.2 x 300	4.0 x 350
Amperage [A]	50 – 70	70 – 100	90 – 130



**Classifications** basic-coated CrNi stick electrode

EN ISO 3581-A	Material-No.
EZ 21 33 B 4 2	~ 1.4850

**Characteristics and field of use**

UTP 2133 Mn is suitable for joining and surfacing of heat-resistant steels and cast steels of the same or of similar nature, such as

1.4876	X10 NiCrAlTi 32 20	UNS	N 08800
1.4859	G-X10 NiCrNb 32 20		
1.4958	X 5 NiCrAlTi 31 20	UNS	N 08810
1.4959	X 8 NiCrAlTi 31 21	UNS	N 08811

It is used for operating temperatures up to 1050 °C in carburized low-sulphur combustion gas, e.g. in petrochemical plants.

**Typical analysis in %**

C	Si	Mn	Cr	Ni	Nb	Fe
0.14	0.5	4.5	21.0	33.0	1.3	balance

**Mechanical properties of the weld metal**

Yield strength $R_{p0.2}$	Tensile strength $R_m$	Elongation $A$	Impact strength $K_V$
MPa	MPa	%	J
> 410	> 600	> 25	> 50

**Welding instructions**

Hold stick electrode vertically with a short arc and lowest heat input. String beads are welded. The interpass temperature of 150 °C should not be exceeded. Re-dry stick electrodes for 2 – 3 h / 250 – 300 °C.

**Welding positions**



Current type DC (+)

**Approvals**

TÜV (No. 07713)

**Form of delivery and recommended welding parameters**

Electrodes $\varnothing \times L$ [mm]	2.5 x 300	3.2 x 350	4.0 x 400
Amperage [A]	50 – 75	70 – 110	90 – 140

## UTP 2535 Nb

nickel alloys

**Classifications**

basic-coated stick electrode with high carbon content

EN ISO 3581-A

Material-No.

EZ 25 35 Nb B 6 2

1.4853

**Characteristics and field of use**

UTP 2535 Nb is suitable for joining and surfacing of heat resistant CrNi-cast steels (centrifugal- and mouldcast parts) of the same or of similar nature, such as

1.4848	G – X 40 CrNiSi 25 20
1.4852	G – X 40 NiCrSiNb 35 26
1.4857	G – X 40 NiCrSi 35 26

It is used for operating temperatures up to 1150 °C in carburized low-sulphur combustion gas, e.g. reforming ovens in petrochemical plants.

**Typical analysis in %**

C	Si	Mn	Cr	Ni	Nb	Ti	Fe
0.4	1.0	1.5	25.0	35.0	1.2	0.1	balance

**Mechanical properties of the weld metal**

Yield strength $R_{p0.2}$	Tensile strength $R_m$	Elongation $A$
MPa	MPa	%
> 480	> 700	> 8

**Welding instructions**

Hold stick electrode vertically with a short arc and lowest heat input. String beads are welded. The interpass temperature of 150 °C should not be exceeded. Re-dry stick electrodes for 2 – 3 h / 250 – 300 °C

**Welding positions**

Current type DC (+)

**Form of delivery and recommended welding parameters**

Electrodes $\varnothing \times L$ [mm]	2.5 x 300	3.2 x 350	4.0 x 400	5.0 x 400
Amperage [A]	50 – 70	70 – 120	100 – 140	

**Classifications** basic-coated special stick electrode for high-temperature cast alloys

EN ISO 14172

E Ni Z 6701 (NiCr35Fe15Nb0.8)

### Characteristics and field of use

UTP 3545 Nb is suitable for joining and surfacing on identical and similar high-heat-resistant cast alloys (centrifugal- and mould cast parts), such as G-X45NiCrNbSiTi45 35. The main application field is tubes and cast parts of reformer and pyrolysis ovens.

The weld deposit is used in low-sulphur, carburizing atmosphere up to 1.175 °C. It yields excellent creep strength and a good resistance against carburization and oxidation.

### Typical analysis in %

C	Si	Mn	Cr	Ni	Nb	Fe
0.45	1.0	0.8	35.0	45.0	0.9	balance

### Mechanical properties of the weld metal

Yield strength $R_{p0.2}$	Tensile strength $R_m$
MPa	MPa
480	680

### Welding instructions

Clean weld area thoroughly. Weld the stick electrode with a slight tilt and a short arc. No pre-heating or post weld heat treatment required. Keep heat input as low as possible and interpass temperature of max. 150 °C. Re-baking: 2 h / 120 – 200 °C.

### Welding positions

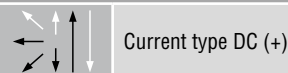

### Form of delivery and recommended welding parameters

Electrodes $\varnothing \times L$ [mm]	2.5 x 300	3.2 x 350	4.0 x 350
Amperage [A]	70 – 90	90 – 110	100 – 140

## UTP 4225

### Classifications

covered electrode

EN ISO 14172

Material-No.

E Ni 8165 (NiCr25Fe30Mo)

2.4652

### Characteristics and field of use

UTP 4225 is suitable for joining and surfacing of alloys of similar nature, such as e.g. NiCr21Mo, furthermore for welding of CrNiMoCu-alloyed austenitic steels used for high quality tank and apparatus construction in the chemical industry, corrosion resistance in media of sulphuric- and phosphoric acid.

The stick electrode can be welded in all positions except vertical-down. Stable arc, easy slag removal. The seam is finely rippled and notch-free. The weld metal UTP 4225 is resistant against pitting and stress corrosion cracking in media containing chloride ions. High resistance against reducing acids due to the combination of nickel, molybdenum and copper. Resistant in oxidising acids. UTP 4225 results in a fully austenitic weld metal.

### Typical analysis in %

C	Si	Mn	Cr	Mo	Ni	Cu	Fe
< 0.03	0.4	2.5	26.0	6.0	40.0	1.8	balance

### Mechanical properties of the weld metal

Yield strength $R_{p0.2}$	Tensile strength $R_m$	Elongation $A$	Impact strength $K_v$
MPa	MPa	%	J
> 350	> 550	> 30	> 80

### Welding instructions

The welding zone must be free from residues. Opening angle of the prepared seam 70 – 80 °, root gap approx. 2 mm. Weld stick electrode with a slight tilt and with short arc. String beads are welded, if necessary, with little weaving, max. weaving width 2.5 x diameter of the stick electrode core wire. Weldable with very low current adjustment. The end crater should be filled thoroughly and the arc must be drawn away to the side. Re-dry the stick electrodes for 2 – 3 h / 250 – 300 °C before use and weld them out of a warm electrode carrier.

### Welding positions



Current type DC (+)

### Approvals

TÜV (No. 06680)

### Form of delivery and recommended welding parameters

Electrodes $\varnothing \times L$ [mm]	3.2 x 350	4.0 x 350
Amperage [A]	70 – 100	90 – 120

**Classifications** basic-coated NiCrMo stick electrode

EN ISO 14172	AWS A5.11	Material-No.
E Ni 6117 (NiCr22Co12Mo)	ENiCrCoMo-1 (mod.)	2.4628

**Characteristics and field of use**

UTP 6170 Co is suitable for joining high-temperature and similar nickel-base alloys, heat resistant austenitic and cast alloys, such as 2.4663 (NiCr23Co12Mo), 2.4851 (NiCr23Fe), 1.4876 (X10 NiCrAlTi 32 21), 1.4859 (GX10 NiCrSiNb 32 20). The weld metal is resistant to hot-cracking and is used for service temperatures up to 1100 °C. Scale-resistance up to 1100 °C in oxidizing and carburized atmospheres, e.g. gasturbines, ethylene production plants.

UTP 6170 Co can be welded in all positions except vertical-down. It has a stable arc. The seam is finely rippled and notch-free. Easy slag removal.

Preheating temperature should be adjusted to the base material. Post weld heat treatments can be applied independently of the weld metal.

**Typical analysis in %**

C	Si	Mn	Cr	Mo	Ni	Co	Al	Ti	Fe
0.06	0.7	0.1	21.0	9.0	balance	11.0	0.7	0.3	1.0

**Mechanical properties of the weld metal**

Yield strength $R_{p0.2}$	Tensile strength $R_m$	Elongation $A$	Impact strength $K_V$
MPa	MPa	%	J
> 450	> 700	> 35	> 80

**Welding instructions**

Hold stick electrode as vertically as possible, keep a short arc. Use string bead technique. Fill end crater carefully. Interpass temperature max. 150 °C. Re-dry stick electrodes for 2 – 3 h / 250 – 300 °C.

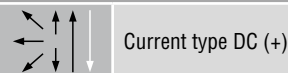
**Welding positions**

**Approvals**

TÜV (No. 04661)

**Form of delivery and recommended welding parameters**

Electrodes $\varnothing \times L$ [mm]	2.5 x 250	3.2 x 300	4.0 x 350
Amperage [A]	55 – 75	70 – 90	90 – 110

## UTP 6222 Mo

nickel alloys

## Classifications

basic-coated NiCrMo-stick electrode

EN ISO 14172

AWS A5.11

Material-No.

E Ni 6625 (NiCr22Mo9Nb)

E NiCrMo-3

2.4621

## Characteristics and field of use

UTP 6222 Mo is particularly suited for joining and surfacing on nickel alloys, austenitic steels, low temperature nickel steels, austenitic-ferritic-joints and claddings of the same or similar nature, like 2.4856 (NiCr22Mo 9 Nb), 1.4876 (X30 NiCrAlTi 32 20), 1.4529 (X2 NiCrMoCu 25 20 5).

The weld metal is heat resistant and suitable for operating temperatures up to 1000 °C. It must be noted that a slight decrease in ductility will occur if prolonged heat treatment is given within the temperature range 600 – 800 °C. Scale-resisting in low-sulphur atmosphere up to 1100 °C. High creep strength.

## Typical analysis in %

C	Si	Mn	Cr	Mo	Ni	Nb	Fe
0.03	0.4	0.6	22.0	9.0	balance	3.3	< 1

## Mechanical properties of the weld metal

Yield strength $R_{p0.2}$	Tensile strength $R_m$	Elongation $A$	Impact strength $K_V$	
MPa	MPa	%	J	-196 °C
> 450	> 760	> 30	> 75	45

## Welding instructions

Opening angle of the prepared seam approx. 70 °, root gap approx. 2 mm. Weld stick electrode with slight tilt and short arc. String beads are welded. The interpass temperature of 150 °C and a max. weaving with 2.5 x diameter of the stick electrode core wire should not be exceeded. Re-dry the stick electrodes 2 – 3 h / 250 – 300 °C before use and weld them out of a warm electrode carrier.

## Welding positions



Current type DC (+)

## Approvals

TÜV (No. 03610), DNV GL, ABS, BV

## Form of delivery and recommended welding parameters

Electrodes $\varnothing \times L$ [mm]	2.5 x 250	3.2 x 300	4.0 x 350	5.0 x 400
Amperage [A]	50 – 70	70 – 95	90 – 120	120 – 160

**Classifications**

basic-coated NiCrFe stick electrode

EN ISO 14172

AWS A5.11

Material-No.

E Ni 6704 (NiCr25Fe10Al3YC)

E NiCrFe-12

2.4649

**Characteristics and field of use**

UTP 6225 AI is suitable for joining high-temperature and heat resistant nickel-base alloys of identical and similar nature, such as 2.4633 (NiCr25-FeAlY), 2.4851 (NiCr23Fe) and high nickel containing cast alloys.

The special features of the weld metal include an excellent resistance against oxidation and carburization and a good creep rupture strength. For service temperature up to 1200°C, e.g. steel tubes, rolls and baffles in ovens, ethylene cracking tubes, muffles.

**Typical analysis in %**

C	Si	Mn	Cr	Ni	Ti	Zr	Al	Fe	Y
0.2	0.6	0.1	25.0	balance	0.1	0.03	1.8	10.0	0.02

**Mechanical properties of the weld metal**

Yield strength $R_{p0.2}$	Tensile strength $R_m$	Elongation $A$	Impact strength $K_V$
MPa	MPa	%	J
> 500	> 700	> 15	> 30

**Welding instructions**

Hold stick electrode as vertically as possible, keep a short arc. Use string beads technique and fill end crater carefully. Interpass temperature max. 150°C. Re-dry stick electrodes for 2 – 3 h / 250 – 300°C.

**Welding positions**

Current type DC (+)

**Form of delivery and recommended welding parameters**

Electrodes $\varnothing \times L$ [mm]	2.5 x 250	3.2 x 300	4.0 x 350
Amperage [A]	50 – 65	80 – 95	90 – 120

## UTP 7015

nickel alloys

## Classifications

basic-coated stick electrode

EN ISO 14172

AWS A5.11

Material-No.

E Ni 6182 (NiCr15Fe6Mn)

E NiCrFe-3

2.4807

## Characteristics and field of use

UTP 7015 is employed for joining and surfacing of nickel-base materials. UTP 7015 is also recommended for welding different materials, such as austenitic to ferritic steels, as well as for weld claddings on unalloyed and low-alloyed steels, e.g. for reactor construction.

Weldable in all positions, except vertical down. Stable arc, good slag removability. The seam is finely rippled and notch-free. The weld deposit has a fully austenitic structure and is high-temperature resistant. Not prone to embrittlement either at high or low temperatures

The preheating must be matched to the parent metal. Any thermal post-treatments can be applied without regard for the weld metal.

## Typical analysis in %

C	Si	Mn	Cr	Ni	Nb	Fe
0.025	0.4	6.0	16.0	balance	2.2	6.0

## Mechanical properties of the weld metal

Yield strength $R_{p0.2}$	Tensile strength $R_m$	Elongation A	Impact strength $K_v$		Hardness Brinell
MPa	MPa	%	J	- 196 °C	HB
400	670	40	120	80	approx. 170

## Welding instructions

Opening angle of the prepared seam approx. 70 °, root gap approx. 2 mm. The stick electrode is welded with a slight tilt and short arc. Use string beads welding technique. The interpass temperature of 150 °C and a max. weaving width 2.5 x diameter of the stick electrode core wire should not be exceeded. Re-dry stick electrode prior welding for 2 – 3 h / 250 – 300 °C, welding out of a hot stick electrode carrier.

## Welding positions



Current type DC (+)

## Approvals

TÜV (No. 00875), DNV GL, KTA (No. 08036)

## Form of delivery and recommended welding parameters

Electrodes $\varnothing \times L$ [mm]	2.5 x 300	3.2 x 300	4.0 x 350	5.0 x 400
Amperage [A]	50 – 70	70 – 95	90 – 120	120 – 160



## Classifications

basic-coated stick electrode

EN ISO 14172

AWS A5.11

E Ni 6093 (NiCr15Fe8NbMo)

E NiCrFe-2

## Characteristics and field of use

UTP 7015 Mo is a basic-coated stick electrode for joining similar heat-resistant NiCrFe alloys, heat-resistant austenitic steels, cryogenic Ni-steels and heat-resistant austenitic-ferritic steels. It can also be used for joining high-C-containing 25/35 CrNi cast steel to 1.4859 or 1.4876 for petrochemical applications and for industrial furnace applications with service temperatures up to 900 °C. Welding dissimilar joints of low-alloyed CMn steels (as e.g. S 235 JR, S 355 N, 16Mo3) with the above-mentioned alloys and steel grades is possible as well.

The weld deposit of UTP 7015 Mo is hot-crack-resistant, not prone to embrittlement, and scale- & corrosion-resistant at elevated temperatures.

## Base materials

2.4816 (NiCr 15 Fe), 1.4583 (X10 CrNiMoNb 18 12),  
1.4876 (X10 NiCrTiAl 32 20), 1.4941 (X8 CrNiTi 18 10)

## Typical analysis in %

C	Si	Mn	Cr	Mo	Nb	Ni	Fe
0.04	0.4	3.0	16.0	1.5	2.2	balance	6.0

## Mechanical properties of the weld metal

Yield strength $R_{p0.2}$	Tensile strength $R_m$	Elongation $A$	Impact strength $K_V$
MPa	MPa	%	J
> 380	> 620	> 35	> 80

## Welding instructions

UTP 7015 Mo can be welded in all positions except vertical down (PG/3Gd). In PA (1G) position, the angle between the plate and the electrode should be kept between 80 – 90 °. The electrode should be welded with a short arc, with dragging – and stringer bead technique. End craters should be filled sufficiently to avoid imperfections related to this. Keep interpass temperature below 150 °C. Re – dry electrodes for 2 – 3 h / 250 – 300 °C, prior to use, unless used for the first time out of a sealed tin.

## Welding positions



Current type DC (+)

## Approvals

TÜV (05259), DNV GL

## Form of delivery and recommended welding parameters

Electrodes $\varnothing \times L$ [mm]	2.5 x 300	3.2 x 300	4.0 x 350	5.0 x 400
Amperage [A]	50 – 70	70 – 95	90 – 120	120 – 160

## Covered electrodes for repair of cracked material

### 4. Cast iron

Product name	EN ISO		AWS		Page
UTP 5 D	1071	EZ FeC-GF			49
UTP 8	1071	E C Ni-C 1	A5.15	E Ni-CI	50
UTP 83 FN	1071	E C NiFe-11	A5.15	E NiFe-CI	51
UTP 85 FN	1071	E C NiFe-13	A5.15	E NiFe-CI	52
UTP 86 FN	1071	E C NiFe-13	A5.15	E NiFe-CI	53
UTP 86 FN-5	1071	E C NiFe-13	A5.15	E NiFe-CI	54

#### Solution examples

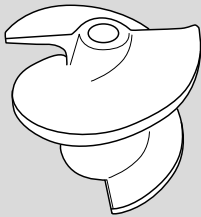

*Screw press*

UTP 8

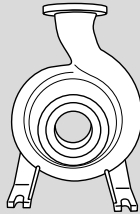

*Pump body*

UTP 83 FN

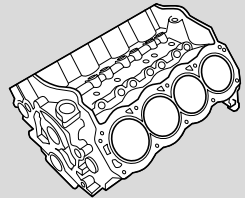

*Engine block*

UTP 86 FN

**Classifications**

graphite-basic-coated stick electrode

EN ISO 1071

EZ FeC-GF

**Characteristics and field of use**

UTP 5 D is suited for cast iron hot welding (identical in colour and structure) nodular cast iron (GJS) and grey cast iron (GJL). The mechanical properties are obtained by heat treatment in accordance with the base metal being used.

UTP 5 D has a smooth arc and little slag, therefore, slag removal on pipe cavity and repair welds is not necessary.

**Typical analysis in %**

C	Si	Mn	Fe
3.0	3.0	0.4	balance

**Mechanical properties of the weld metal**

Yield strength $R_{p0.2}$	Tensile strength $R_m$	Hardness
MPa	MPa	HD
approx. 350	approx. 550	approx. 220

**Welding instructions**

Preheating of weldment to 550 – 650 °C. Interpass temperature at a minimum of 550 °C. Slow cooling of the weldment (< 30 °C / h) or covered cooling.

**Welding positions**

Current type DC (–) / AC

**Form of delivery and recommended welding parameters**

Electrodes $\varnothing \times L$ [mm]	3.2 x 350*	4.0 x 450*	8.0 x 450*
Amperage [A]	75 – 140	110 – 160	250 – 300

\*available on request

## UTP 8

cast iron

<b>Classifications</b>	graphite-basic-coated stick electrode
------------------------	---------------------------------------

EN ISO 1071	AWS A5.15
-------------	-----------

E C Ni-CI 1	E Ni-CI
-------------	---------

**Characteristics and field of use**

UTP 8 is for cold welding of grey and malleable cast iron, cast steel and for joining these base metals to steel, copper and copper alloys, especially for repair and maintenance.

UTP 8 has excellent welding properties. The easily controllable flow permits spatterfree welding in all positions and with minimal amperage. The weld deposit and the transition zones are filable. No undercutting. Ideally suited for the combined welding with the ferro-nickel type UTP 86 FN (buttering with UTP 8 and filling with UTP 86 FN).

**Typical analysis in %**

C	Ni	Fe
1.2	balance	1.0

**Mechanical properties of the weld metal**

<i>Yield strength</i> $R_{p0.2}$	<i>Hardness</i>
<i>MPa</i>	<i>HB</i>
approx. 220	approx. 180

**Welding instructions**

Depending on the wall thickness, the preparation is made in U- or double U-form. The casting skin has to be removed on both sides of the welding area. Hold the stick electrode vertically with a short arc. Thin passes are buttered, their width not more than twice the diameter of the core wire. To avoid over-heating, the beads should not be longer than 10 times the stick electrode diameter. Remove the slag immediately after welding and then peen the deposit carefully. Reignite on the weld deposit and not on the base metal.

**Welding positions**

Current type DC ( - ) / AC

**Approvals**

DB (No. 62.138.01)

**Form of delivery and recommended welding parameters**

<i>Electrodes</i> $\varnothing \times L$ [mm]	2.0 x 300	2.5 x 300	3.2 x 350	4.0 x 350
<i>Amperage</i> [A]	45 – 60	60 – 80	80 – 100	110 – 140

**Classifications** graphite-basic-coated FeNi stick electrode

EN ISO 1071 AWS A5.15

E C NiFe-11 E NiFe-CI

## Characteristics and field of use

UTP 83 FN is suitable for surfacing and joining of all commercial cast iron grades, such as lamellar grey cast iron and nodular cast iron, malleable cast iron and for joining these materials to steel or cast steel. This stick electrode is particularly used where a high deposition rate is needed.

UTP 83 FN has an excellent melting performance and the easily controllable transfer provides a spatterfree deposit of perfect appearance. The weld deposit is easily machinable with cutting tools, tough and crack-resistant.

Hardness of the pure weld metal: approx. 190 HB

## Typical analysis in %

C	Ni	Fe
1.3	52.0	balance

## Welding instructions

The casting skin and impurities have to be removed from the welding area. Weld with low amperage and short arc. For the purpose of stress relief in case of difficult weldings, peen the weld metal and reduce the heat input by welding short beads.

## Welding positions



Current type DC (+) / AC

## Form of delivery and recommended welding parameters

<i>Electrodes</i> Ø x L [mm]	2.5 x 300	3.2 x 350	4.0 x 350
<i>Amperage</i> [A]	50 – 70	70 – 100	100 – 130

## UTP 85 FN

cast iron

## Classifications

Graphite-basic-coated FeNi stick electrode

EN ISO 1071

AWS A5.15

E C NiFe-1 3

E NiFe-CI

## Characteristics and field of use

UTP 85 FN is suitable for surfacing and joining of all grades of cast iron, particularly nodular cast iron (GJS 38-60) and for joining these materials with steel and cast steel.

UTP 85 FN has excellent welding properties and a smooth, regular flow, a high deposition rate and a finely rippled bead appearance. Very economic for construction and production welding on nodular cast iron parts. High current carrying capacity thank to a bimetallic core wire.

## Typical analysis in %

C	Ni	Fe
1.2	54.0	balance

## Mechanical properties of the weld metal

Yield strength $R_{p0.2}$	Hardness
MPa	HB
approx. 320	approx. 200

## Welding instructions

Prior to welding, the casting skin has to be removed from the welding area. Hold the stick electrode vertically and with a short arc. Apply string beads – if necessary, with very little weaving. Peen the deposit after slag removal for the purpose of stress relief. Avoid high heat concentration.

## Welding positions

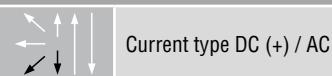

## Form of delivery and recommended welding parameters

Electrodes $\varnothing \times L$ [mm]	2.5 x 300	3.2 x 350	4.0 x 350	5.0 x 400
Amperage [A]	50 – 70	70 – 100	100 – 130	130 – 160

**Classifications** graphite-basic-coated FeNi stick electrode

EN ISO 1071 AWS A5.15

E C NiFe-13 E NiFe-CI

### Characteristics and field of use

UTP 86 FN is suitable for joining and surfacing of lamellar grey cast iron EN GJL 100 to EN GJL 400, nodular cast iron (spheroidal cast iron) EN GJS 400 to EN GJS 700 and malleable cast iron grades EN GJMB 350 to EN GJMB 650 as well as for joining these materials with each other or with steel and cast steel. Universally applicable for repair, construction and production welding.

UTP 86 FN has excellent buttering characteristics on cast iron. The stick electrode has a stable arc and produces a flat seam structure without undercutting. Particularly for fillet welds an optimal seam structure is achieved (e.g. welding GJS-flanges or sockets to GJS-tubes). Due to the bimetallic core wire, the current carrying capacity and the deposition rate are excellent. The bead appearance is smooth. The weld deposit is highly crack resistant and easily machinable with cutting tools.

### Typical analysis in %

C	Ni	Fe
1.2	balance	45.0

### Mechanical properties of the weld metal

Yield strength $R_{p0.2}$	Hardness
MPa	HB
approx. 340	approx. 220

### Welding instructions

UTP 86 FN is preferably welded on DC (negative polarity) or on AC. When welding on DC (neg. polarity), a deep penetration is reached (advantage for fillet welds). Positional weldings are easier with AC. Prior to welding, remove the casting skin. Hold stick electrode vertically and with short arc. When welding cracksusceptible cast iron grades, the deposit may be peened for the purpose of stress relief.

### Welding positions



Current type DC (-) / AC

### Approvals

DB (No. 62.138.05)

### Form of delivery and recommended welding parameters

Electrodes $\varnothing \times L$ [mm]	2.5 x 300	3.2 x 350	4.0 x 350
Amperage [A]	60 – 90	90 – 140	100 – 170

## UTP 86 FN-5

cast iron

## Classifications

graphite-basic-coated FeNi stick electrode

EN ISO 1071

AWS A 5.15

E C NiFe-1 3

E NiFe-CI

## Characteristics and field of use

UTP 86 FN-5 was developed for high-quality production and construction welds of cast iron with nodular graphite (spheroidal cast iron). Dissimilar joints with steel are possible. It is mainly used in production welding of ferritic spheroidal cast iron with specific mechanical properties, such as EN-GJS-400-18-LT

The used NiFe-bimetallic core wire gives the stick electrode a high current carrying capacity and a good deposition rate. Good wetting characteristics on cast iron are achieved by the stable arc and smooth flow. The deposit is highly crack resistant with good strength and toughness. Machining is possible.

## Typical analysis in %

C	Si	Mn	Fe	Ni
1.2	0.5	0.3	45.0	balance

## Mechanical properties\* of the pure weld metal after heat treatment 2 h / 920 °C

Yield strength $R_{p0.2}$	Tensile strength $R_m$	Elongation A	Impact strength $K_v$	Hardness Brinell
MPa	MPa	%	J	HB
> 250	> 480	> 20	> 15	approx. 170

\* Mechanical properties cannot be guaranteed for diameter 2.5 mm

## Welding instructions

Prior to welding, clean the weld area, remove casting skin and check for any cracks. Hold the electrode vertically and keep a short arc. Large parts can be preheated to 80 °C. For the purpose of stress relieving, it is recommended to peen the deposit directly after welding.

## Welding positions



Current type DC (–) / AC

## Form of delivery and recommended welding parameters

Electrodes $\varnothing \times L$ [mm]	2.5 x 300	3.2 x 350	4.0 x 350
Amperage [A]	65 – 90	90 – 140	100 – 170



## Covered electrodes for repair of cracked material

### 5. Copper alloys

Product name	DIN		AWS		Mat.-No.	Page
UTP 32	1733	EL-CuSn7	A5.6	E CuSn-C (mod.)	2.1025	56
UTP 39	1733	EL-CuMn2	A5.6	ECu (mod.)	2.1363	57
UTP 320	1733	EL-CuSn13			2.1027	58
UTP 387	1733	EL-CuNi30Mn	A5.6	E CuNi	2.0837	59

#### Solution examples

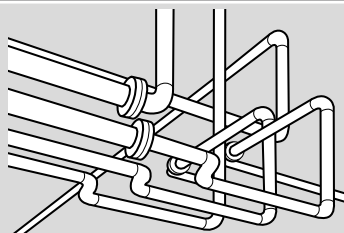

*Piping*

UTP 32

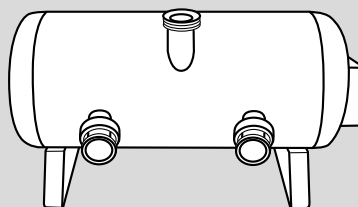

*Pressure vessel*

UTP 387

## UTP 32

copper alloys

## Classifications

basic-coated tin-bronze stick electrode

DIN 1733

AWS A5.6

Material-No.

EL-CuSn7

E CuSn-C (mod.)

2.1025

## Characteristics and field of use

UTP 32 is a basic-coated tin-bronze stick electrode for joining and surfacing on copper tin alloys with 6 – 8 % Sn, copper-tin alloys and for weld claddings on cast iron materials and on steel.

UTP 32 is easily weldable; good slag removal. The corrosion-resistance is corresponding to identical or similar base metals. Good gliding properties.

## Typical analysis in %

Cu	Sn
balance	7.0

## Mechanical properties of the weld metal

Yield strength $R_{p0.2}$	Tensile strength $R_m$	Hardness	Electrical conductivity	Melting range
MPa	MPa	HD	$S \times m / mm^2$	°C
approx. 300	> 30	approx. 100	approx. 7	910 – 1040

## Welding instructions

Clean welding area thoroughly. Ignite stick electrode inclined with scratch start. For wall thickness of > 8 mm a preheating of 100 – 250 °C is necessary. Hold stick electrode vertically and weave slightly. Use only dry stick electrodes. Re-drying 2 – 3 h / 150 °C.

## Welding positions



Current type DC (+)

## Form of delivery and recommended welding parameters

Electrodes $\varnothing \times L$ [mm]	2.5 x 300	3.2 x 350	4.0 x 350
Amperage [A]	60 – 80	80 – 100	100 – 120

**Classifications** basic-coated pure copper stick electrode

DIN 1733	AWS A5.6	Material-No.
EL-CuMn2	ECu (mod.)	2.1363

**Characteristics and field of use**

The pure copper stick electrode is suitable for joining and surfacing of all commercial pure, oxygen-free copper grades acc. to DIN 1976, such as:

Material.no.	Short mark
CW008A	Cu-OF
CW021A	Cu-HCP
CW023A	Cu-DLP
CR024A	Cu-DHP

UTP 39 shows a pore-free, well-deoxidized and crack-proof weld metal. Its corrosion resistance is equal to commercial copper grades.

**Typical analysis in %**

Cu	Mn
> 97	1.5

**Mechanical properties of the weld metal**

<i>Yield strength</i> $R_{p0.2}$	<i>Hardness</i>	<i>Elongation</i>	<i>Electrical conductivity</i>	<i>Melting range</i>
MPa	HB	%	$S \times m / mm^2$	°C
> 200	approx. 60	> 35	approx. 20	1000 – 1050

**Welding instructions**

Clean welding zone thoroughly. Pre-heating of copper to 400 – 600 °C depending on wall thickness, maintain the temperature during the welding process. Keep the arc short with steep (vertical up) stick electrode guidance. Choose the biggest possible diameter of stick electrode. Use dry stick electrodes only. If necessary, re-drying for 2–3 h / 150 °C.

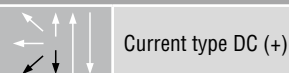
**Welding positions****Approvals**

DB (No. 63.138.02)

**Form of delivery and recommended welding parameters**

<i>Electrodes</i> $\varnothing \times L$ [mm]	2.5 x 350	3.2 x 350	4.0 x 450
<i>Amperage</i> [A]	60 – 90	80 – 100	110 – 130

## UTP 320

copper alloys

## Classifications

Basic-coated bronze stick electrode with 13 % Sn

DIN 1733

Material-No.

EL-CuSn13

2.1027

## Characteristics and field of use

UTP 320 is suitable for joining and surfacing on copper-tin alloys (bronze) with more than 8% Sn, copper-zinc alloys (brass), copper-zinc-lead alloys as well as for cladding on steel and cast-iron.

Tin bronzes:

Standards	Material-no.	Short mark
EN 12449	CW453K	CuSn 8
EN 1982	CB491K	CuSn 5 Zn5Pb5-B
EN 1982	CB493K	CuSn 7 Zn4Pb7-B

UTP 320 is easily weldable with easy slag removal. The corrosion resistance is corresponding to identical or similar base metals. Seawater-resistant. Very good gliding properties.

## Typical analysis in %

Cu	Sn
87.0	13.0

## Mechanical properties of the weld metal

Yield strength $R_{p0.2}$	Hardness	Electrical conductivity	Melting range
MPa	HB	$S \times m / mm^2$	°C
approx. 350	approx. 140	3 – 5	825 – 990

## Welding instructions

Clean welding area thoroughly. Ignite stick electrode inclined with scratch start. For wall thickness of > 8 mm a pre-heating of 100 – 250 °C is necessary. Hold stick electrode vertically and weave slightly. Use dry stick electrodes only. Re-drying for 2 – 3 h / 150 °C.

## Welding positions

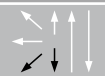

Current type DC (+)

## Form of delivery and recommended welding parameters

Electrodes $\varnothing \times L$ [mm]	2.5 x 350	3.2 x 350	4.0 x 450
Amperage [A]	60 – 80	80 – 100	100 – 120

<b>Classifications</b>		basic-coated copper-nickel stick electrode 70 / 30
DIN 1733	AWS A5.6	Material-No.
EL-CuNi30Mn	E CuNi	2.0837

### Characteristics and field of use

The copper-nickel base stick electrode UTP 387 is used for joining and surfacing alloys of similar compositions with up to 30% nickel, as well as non-ferrous alloys and steels of different nature. The seawater-resistant weld metal enables this special stick electrode to be employed in ship-building, oil refineries, the food industry and in the engineering of corrosion-proof vessels and equipment generally.

UTP 387 can be welded in all positions, except vertical-down, seawater resistant.

### Typical analysis in %

C	Si	Mn	Ni	Cu	Fe
0.03	0.3	1.2	30.0	balance	0.6

### Mechanical properties of the weld metal

<i>Yield strength</i> $R_{p0.2}$	<i>Tensile strength</i> $R_m$	<i>Elongation</i> $A$	<i>Impact strength</i> $K_V$
MPa	MPa	%	J
> 240	> 390	> 30	> 80

### Welding instructions

Groove out a V seam with min. 70 °C and provide a root gap of 2 mm. Remove the oxide skin about 10 mm beside the joint, on the reverse side too. The weld zone must be bare and properly de-greased. Fuse the arc strike point again by bringing the stick electrode back, in order to obtain a good bond. Keep the arc short.

### Welding positions

	Current type DC (+)
---	---------------------

### Approvals

TÜV (No. 01626), GL

### Form of delivery and recommended welding parameters

<i>Electrodes</i> $\varnothing \times L$ [mm]	2.5 x300*	3.2 x 350	4.0 x 350*
<i>Amperage</i> [A]	60 – 80	80 – 105	110 – 130

\*available on request

## Surfacing electrodes for anti-wear and anti-corrosion applications

Product name	DIN		AWS		Type of wear								Page
					Abrasion	Corrosion	Erosion	Cavitation	Heat	Impact	Metal to Earth	Metal to Metal	
UTP 34 N	14700	E Cu1	A5.13	E CuMnNiAl 1		■		■				■	61
UTP 67 S	14700	E Fe8			■				■	■		■	62
UTP 73 G 2	14700	E Fe8			■		■		■	■		■	63
UTP 73 G 3	14700	E Fe3			■		■		■	■		■	64
UTP 73 G 4	14700	E Z Fe3			■		■		■	■		■	65
UTP 75	14700	EZ Fe20			■						■		66
UTP 665	14700	E Fe7				■				■		■	67
UTP 670	14700	EZ Fe8			■				■	■	■	■	68
UTP 673	14700	E Z Fe3			■		■		■	■		■	69
UTP 690	14700	E Fe4	A5.13	E Fe 5-B(mod.)					■			■	70
UTP 700	14700	EZ Ni2	A5.11	~ E NiCrMo-5					■	■			71
UTP 702	14700	E Fe5							■	■		■	72
UTP 750	14700	E Z Fe6				■			■	■		■	73
UTP 7000	14700	E Z Ni2				■			■	■		■	74
UTP 7008	14700	E Z Ni2				■			■	■		■	75
UTP 7010	14700	EZ Co1				■			■	■			76
UTP 7100	14700	E Z Fe14			■						■		77
UTP 7200	14700	E Z Fe9	A5.13	E-FeMn-C						■		■	78
UTP BMC	14700	E Fe9								■		■	79
UTP CELSIT 701	14700	E Co3	A5.13	E CoCr-C									80
UTP CELSIT 706	14700	E Z Co2	A5.13	E CoCr-A	■	■	■	■	■	■		■	81
UTP CELSIT 712	14700	E Co3	A5.13	E CoCr-B	■	■	■	■	■	■		■	82
UTP CELSIT 721	14700	E Co1	A5.13	E CoCr-E	■	■	■	■	■	■		■	83
UTP Chronos	14700	E Fe9								■		■	84
UTP DUR 250	14700	E Fe1										■	85
UTP DUR 350	14700	E Fe1								■		■	86
UTP DUR 600	14700	E Fe8			■		■			■	■	■	87
UTP DUR 650 Kb	14700	E Fe8			■		■		■	■	■	■	88
UTP HydroCav	14700	E Z Fe9				■	■	■		■			89
UTP LEDURIT 61	14700	E Z Fe14	A5.13	~ E FeCr-A 1	■		■				■		90
UTP LEDURIT 65	14700	E Fe16			■		■		■		■		91

**Classifications** basic-coated complex aluminiumbronze stick electrode

DIN 8555	EN 14700	AWS A5.13
E 31-UM-200-CN	E Cu1	E CuMnNiAl

### Characteristics and field of use

UTP 34 N is suitable for joinings and surfacings on copper-aluminium alloys, specially with high Mn-content as well as for claddings on cast iron materials and steel. Main application fields are in the shipbuilding (propeller, pumps, armatures) and in the chemical industry. The good friction coefficient permits claddings on shafts, bearings, stamps, drawing tools and all kind of gliding surface.

UTP 34 N has excellent welding properties, spatterfree welding, good slag removal. The weld deposit has high mechanical values, a good corrosion resistance in oxidizing media, best gliding properties and a very good machinability. Crack resistant and pore-free.

### Typical analysis in %

Mn	Ni	Cu	Al	Fe
13.0	2.5	balance	7.0	2.5

### Mechanical properties of the weld metal

Yield strength $R_{p0.2}$	Tensile strength $R_m$	Elongation $A$	Hardness
MPa	MPa	%	HB
400	650	15	220

### Welding instructions

Clean welding area thoroughly. Pre-heating of thick-walled parts to 150 – 250 °C. Hold electrode as vertically as possible and weld with slight weaving. Weld with dry stick electrodes only! Re-drying: 2 – 3 h / 150 °C.

### Welding positions

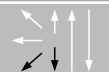

Current type DC (+)

### Form of delivery and recommended welding parameters

Electrodes $\varnothing \times L$ [mm]	2.5 x 350	3.2 x 350	4.0 x 350
Amperage [A]	50 – 70	70 – 90	90 – 110

**Classifications**

Basic-coated hardfacing electrode

DIN 8555

EN 14700

E 6-UM-60-S

E Fe8

**Characteristics and field of use**

UTP 67 S is universally applicable on workpieces of steel, cast steel or hard Mn-steel subject to a combination of impact, compression and abrasive wear, such as cams, drums, bearing surfaces, rollers, rails, gear wheels, plough blades, stamping mills, crusher jaws, beaters, excavator parts, rope pulleys, baffle plates, brick presses, etc. Another area in which this electrode has yielded excellent results is the building-up of cutting edges of cold-cutting tools (Cr cutting steels) in the automotive industry.

Hardness of the pure weld deposit

56 – 58 HRC

after soft-annealing

820 °C / furnace

approx. 25 HRC

after hardening

850 °C / oil

52 – 54 HRC

1000 °C / oil

60 – 62 HRC

**Typical analysis in %**

C	Si	Mn	Cr	Fe
0.5	3.0	0.5	9.0	balance

**Welding instructions**

Hold stick electrode as vertically as possible and keep a short arc. Preheating is only necessary for surfacing higher-carbon materials; for tool steels a preheat temperature of 300 – 400 °C is required. Re-dry stick electrodes for 2 h / 300 °C.

**Welding positions**

Current type DC (-) / DC (+) / AC

**Form of delivery and recommended welding parameters**

<i>Electrodes</i> Ø x L [mm]	2.5 x 300	3.2 x 350	4.0 x 350	5.0 x 450
<i>Amperage</i> [A]	50 – 70	70 – 100	110 – 140	140 – 170



**Classifications**

basic-coated stick electrode

DIN 8555

EN 14700

E 3-UM-55-ST

E Fe8

**Characteristics and field of use**

UTP 73 G 2 is, due to its high hardness, toughness and heat-resistance ideally suited for build-ups on parts subject to severe friction, compression and moderate impact loads at elevated temperatures, such as back centers, gripping pliers, gliding and guiding surfaces, hot and cold punching tools, valves, slides, hot-shear blades, extrusion press pistons, forging tools, stripping columns, trimming tools, roll mandrils or punching tools for sheet metals. UTP 73 G 2 is used to good advantage for the production of new cold and hot working tools. In such cases cladding is made on base material with an accordingly high tensile strength.

The stick electrode has excellent welding properties, a stable and regular flow, good bead appearance and very easy slag removal. Heat-resistant up to 550 °C

Hardness of the pure weld metal: 55 – 58 HRC

**Typical analysis in %**

C	Si	Mn	Cr	Mo	Fe
0.35	0.5	1.3	7.0	2.5	balance

**Welding instructions**

Preheat the workpiece to 400 °C. Hold stick electrode as vertically as possible and with a short arc. Allow the workpiece to cool down slowly. Finish by grinding. Re-dry damp stick electrodes damp for 2 h / 300 °C.

**Welding positions**

Current type DC (+) / AC

**Form of delivery and recommended welding parameters**

<i>Electrodes</i> Ø x L [mm]	2.5 x 300	3.2 x 350	4.0 x 400	5.0 x 400
<i>Amperage</i> [A]	60 – 90	80 – 110	100 – 140	130 – 170

**UTP 73 G 3**

anti-wear

**Classifications**

basic-coated stick electrode

DIN 8555

EN 14700

E 3-UM-45-T

E Fe3

**Characteristics and field of use**

UTP 73 G 3 is, due to its high strength, toughness and heat resistance ideally suited for buildups on parts subject to friction, compression and impact at elevated temperatures, such as hot shears blades, gate shear, forging saddles, hammers, forging dies, Al-die cast moulds. UTP 73 G 3 is also used to good advantage for the production of new cold and hot working tools with low-alloy base materials.

The stick electrode has excellent welding properties, a stable and regular flow, good bead appearance and very easy slag removal. Heat resistant up to 550 °C.

Hardness of the pure weld metal: approx. 45 – 50 HRC

**Typical analysis in %**

C	Si	Mn	Cr	Mo	Fe
0.2	0.5	0.6	5.0	4.0	balance

**Welding instructions**

Preheat the workpiece to 400 °C. Hold stick electrode as vertically as possible and with a short arc. Take care of a slow cooling of the workpiece. Finishing by grinding or hard metal alloys. Re-dry stick electrodes that have got damp for 2 h / 300 °C.

**Welding positions**

Current type DC (+) / AC

**Form of delivery and recommended welding parameters**

<i>Electrodes</i> Ø x L [mm]	2.5 x 300	3.2 x 350	4.0 x 400	5.0 x 400*
<i>Amperage</i> [A]	60 – 90	80 – 100	100 – 140	130 – 170

\*available on request

**Classifications**

basic-coated stick electrode

DIN 8555

EN 14700

E 3-UM-40-PT

E Z Fe3

**Characteristics and field of use**

UTP 73 G 4 is, due to its toughness and heat resistance, ideally suited for surfacings on parts and tools subject to abrasion, compression and impact at elevated temperatures. Particularly for buildups on forging dies, die cast moulds, rollers, wobbler drives, hot-shear blades. UTP 73 G 4 also offers an economic solution for the production of new tools, for which a base material with an adequate tensile strength is recommended.

The stick electrode has excellent welding properties, a stable and regular flow, good bead appearance and very easy slag removal. Heat resistant up to 550 °C.

Hardness of the pure weld metal: approx. 38 – 42 HRC

**Typical analysis in %**

C	Si	Mn	Cr	Mo	Fe
0.1	0.5	0.6	6.5	3.5	balance

**Welding instructions**

Preheat the workpiece to 400 °C. Hold stick electrode as vertically as possible and with a short arc. Take care of a slow cooling of the workpiece. Machining is possible with tungstene carbide tools. Re-dry stick electrodes that have got damp for 2 h / 300 °C.

**Welding positions**

Current type DC (+) / AC

**Form of delivery and recommended welding parameters**

<i>Electrodes</i> Ø x L [mm]	2.5 x 300	3.2 x 350	4.0 x 400	5.0 x 400*
<i>Amperage</i> [A]	60 – 90	80 – 100	100 – 140	130 – 170

\*available on request

## UTP 75

anti-wear

**Classifications** Graphite basic-coated stick electrode with sintered core wire

DIN 8555 EN 14700

E21-UM-65-G EZ Fe20

**Characteristics and field of use**

UTP 75 is, thanks to its high hardness, particularly suited for hardfacing of parts subject to extremely severe mineral abrasion with very low impact stress, such as sand mixer blades, conveyor screws in the ceramics industry, earth drills, injection screws of brick moulding machines, teeth and bars of grates in the steel industry, bucket and shovel teeth, strippers on asphalt processing machines, trench milling tools.

UTP 75 has a smooth and stable arc and a self-removing slag. The smooth bead surface does normally not require any machining by grinding with silicon carbide or diamond wheels.

Hardness of the pure weld deposit: approx. 65 HRC

Microhardness of the tungsten carbid es: approx. 2500 HV

**Typical analysis in %**

WC	CrC	Fe
70.0	10.0	balance

**Welding instructions**

Keep an angle of 80 – 90° between plate and electrode, make slightly weaving beads, keep a short arc. Preheating is generally not necessary. Apply max. 2 layers. Re-dry damp electrodes for 2 h / 300°C.

**Welding positions**

Current type DC (-) / AC

**Form of delivery and recommended welding parameters**

<i>Electrodes</i> Ø x L [mm]	4.0 x 300	5.0 x 300*
<i>Amperage</i> [A]	110 – 140	140 – 170

\*available on request

## Classifications

high Cr-alloyed special stick electrode

EN 14700

E Fe7

## Characteristics and field of use

UTP 665 is especially suitable for repairs on tool steels, particularly cutting tools made of 12-% chromium cutting steels, such as 1.2601, 1.2080, 1.2436, 1.2376, 1.2379, on broken or fatigued areas. Modification of moulds can also be done. The mentioned tool steels are particularly used in the car industry as stamping - and pressing tools.

UTP 665 has excellent welding properties. Smooth, stable arc, spatterfree and fine rippled seams without undercutting. Very good slag removal. The weld deposit is equivalent to high alloyed chromium steel, crack - and pore resistant, stainless.

Hardness of the pure weld metal: approx. 250 HB  
 on Cr cutting steel 1 – 2 layers 55 – 57 HRC

## Typical analysis in %

C	Mn	Si	Cr	Fe
0.06	0.8	0.6	17.0	balance

## Welding instructions

Pre-heat 12-% chromium cutting steels to 400 – 450 °C in hardened as well as in soft annealed conditions. Soft-annealing and throughout preheating is recommended at massive tools and prolonged working. Generally a local preheating and peening of the welding bead will be enough for smaller repair works. Slow cooling in oven or under a cover.

## Welding positions



Current type DC (+) / AC

## Form of delivery and recommended welding parameters

<i>Electrodes</i> Ø x L [mm]	2.5 x 250*	3.2 x 350*	4.0 x 350*
<i>Amperage</i> [A]	50 – 70	70 – 100	100 – 130

\*available on request

**UTP 670**

anti-wear

**Classifications**

basic-coated stick electrode

DIN 8555

EN 14700

E 6-UM-60

EZ Fe8

**Characteristics and field of use**

UTP 670 is a high-efficiency stick electrode for hardfacing of workpieces made of steel, cast steel or high Mn-steel, subject to simultaneous wear by impact, compression and abrasion.

Typical applications are crane wheels, rollers, chain links, sprocket wheels, gliding surfaces, screw conveyors, beaters, edge runners, guide wheels, baffle plates etc.

In tool shops this electrode is especially suitable for repair welding of cutting knives, stamps, punches, shear blades or forming tools. UTP 670 can also be used to weld Vanadium-alloyed tool steels.

**Properties of the weld metal**

UTP 670 has a martensitic structure and is suited to hardfacings resistant to wear by impact, compression and slight abrasion.

Hardness of the pure weld deposit approx. 58 HRC

**Typical analysis in %**

C	Si	Mn	Cr	Mo	V	Fe
0.4	1.0	1.0	9.5	0.6	1.5	balance

**Welding instructions**

Hold stick electrode as vertically as possible and keep the arc short.

Preheating and post-weld heat treatment should be carried out depending on wall thickness, geometry, base metal and general requirements. For multi-pass applications it is advisable to weld buffer layers with UTP DUR 250 / UTP 73 G4 and apply UTP 670 for the last 3 layers.

Depending on the requirements, high preheating of high Mn-steels or un-alloyed steels may not be mandatory.

Electrodes should be redried for 2 h / 300 °C.

**Welding positions**

Current type DC (+) / AC

**Form of delivery and recommended welding parameters**

Electrodes $\varnothing \times L$ [mm]	2.5 x 350	3.2 x 450	4.0 x 450	5.0 x 450*
Amperage [A]	70 – 90	90 – 120	130 – 160	170 – 210

\*available on request

**Classifications**

rutile-coated stick electrode

DIN 8555

EN 14700

E 3-UM-60-ST

E Z Fe3

**Characteristics and field of use**

UTP 673 is used for wear resistant buildups on cold and hot working tools, particularly for cutting-edges on hot cutting tools, hot-shear blades, trimming tools and cold cutting knives. The production of new cutting tools by welding on non-alloy or low-alloy base materials is also possible.

UTP 673 has excellent welding properties, a homogeneous, finely rippled bead appearance due to the spray arc and very easy slag removal. This stick electrode is weldable with very low amperage settings (advantage for edge buildup).

Heat resistant up to 550°C Hardness of the pure weld metal: approx. 58 HRC

**Typical analysis in %**

C	Si	Mn	Cr	Mo	V	W	Fe
0.3	0.8	0.4	5.0	1.5	0.3	1.3	balance

**Welding instructions**

Preheat high-alloy tool steels to 400 – 450°C and maintain this temperature during the whole welding process. Hold stick electrode vertically with a short arc and lowest possible amperage setting. Machining only by grinding. Re-dry stick electrodes that have got damp for 2 h / 300°C.

**Welding positions**



Current type DC ( - ) / DC ( + ) / AC

**Form of delivery and recommended welding parameters**

Electrodes Ø x L [mm]	2.0 x 300*	2.5 x 300	3.2 x 350	4.0 x 400
Amperage [A]	30 – 50	50 – 70	90 – 120	130 – 160

\*available on request

## UTP 690

anti-wear

## Classifications

rutile-coated high efficiency stick electrode

DIN 8555

EN 14700

AWS A5.13

E 4-UM-60-ST

E Fe4

E Fe 5-B (mod.)

## Characteristics and field of use

UTP 690 is used for repair and production of cutting tools, particularly for building-up cutting edges and working surfaces. The deposit is highly resistant to friction, compression and impact, also at elevated temperatures up to 550 °C. The production of new tools by welding on non-alloy and low-alloy base metals is also possible (cladding of cutting edges).

UTP 690 has excellent welding properties, a smooth, finely rippled bead appearance due to the spray arc and very easy slag removal. The weld deposit is equivalent to a high speed steel with increased Mo-content.

Hardness of the pure weld metal:

approx. 62 HRC

soft annealed 800 – 840 °C

approx. 25 HRC

hardened 1180 – 1240 °C and tempered 2 x 550 °C

approx. 64 – 66 HRC

## Typical analysis in %

C	Si	Mn	Cr	Mo	V	W	Fe
0.9	0.8	0.5	4.5	8.0	1.2	2.0	balance

## Welding instructions

Clean the welding area and preheat high-speed steel tools to 400 – 600 °C, maintain this temperature during the whole welding process, followed by slow cooling. Machining by grinding is possible. Hold stick electrode vertically and with a short arc. Re-dry stick electrodes that have got damp for 2 h / 300 °C.

## Welding positions



Current type DC (+) / AC

## Form of delivery and recommended welding parameters

<i>Electrodes</i> Ø x L [mm]	2.5 x 350	3.2 x 350	4.0 x 450
<i>Amperage</i> [A]	70 – 90	90 – 110	110 – 130



**Classifications** rutile-coated stick electrode on NiCrMoW base

DIN 8555	EN 14700	AWS A5.11
E 23-UM-200-CKTZ	EZ Ni2	~E NiCrMo-5

**Characteristics and field of use**

UTP 700 is suited for wear-resisting claddings on hot working tools subject to thermal load, such as forging dies, hot piercing plugs, hot cutting knives and press rams, as well as for highly corrosion-resistant claddings, such as e.g. flat faces of armatures.

UTP 700 shows excellent welding properties, a stable spray arc with a finely ripped seam surface and a very easy slag removal. The weld deposit is heat-resistant and highly corrosion-resistant, scale-resistant and work hardening, machinable

**Typical analysis in %**

C	Si	Mn	Cr	Mo	Ni	W	Fe
0.15	1.0	1.0	17.0	18.0	balance	4.5	5.5

**Welding instructions**

Clean welding area to metallic brightness. Preheat tools, depending on base metal, to 200 – 400 °C, hold this temperature during welding. Slow cooling. Hold stick electrode as vertically as possible and weld with a short arc. Select lowest possible amperage in order to prevent dilution with the base metal.  
Re-drying: 2 h / 300 °C.

**Welding positions**



Current type: DC ( + ) / AC

**Form of delivery and recommended welding parameters**

Electrodes Ø x L [mm]	2.5 x 300	3.2 x 300	4.0 x 350
Amperage [A]	45 – 90	70 – 110	100 – 150

**Classifications**

basic-coated martensitic stick electrode

DIN 8555

EN 14700

E 3-UM-350-T

E Fe5

**Characteristics and field of use**

Due to its high-grade structure, UTP 702 is used for repair, preventive maintenance and production of highly stressed cold and hot working tools, such as punching tools, cold shears for thick materials, drawing -, stamping - and trimming tools, hot cutting tools, Al-die cast moulds, plastic moulds, cold forging tools. The weld deposit is, in as-welded condition, easily machinable and the subsequent age hardening optimises the resistance to wear and alternating temperatures.

UTP 702 has excellent welding properties, a smooth and regular drop transfer, good bead appearance and easy slag removal.

Hardness of the pure weld metal:

untreated:	34 – 37 HRC
After age hardening 3 – 4 h / 480 °C	50 – 54 HRC

**Typical analysis in %**

C	Si	Mn	Mo	Ni	Co	Ti	Fe
0.025	0.2	0.6	4.0	20.0	12.0	0.3	balance

**Welding instructions**

Clean welding area to metallic bright. Only massive tools should be preheated to 100 – 150 °C. On lowalloy steels at least 3 – 4 layers should be applied. Keep heat input as low as possible.

**Welding positions**

Current type DC (+)

**Form of delivery and recommended welding parameters**

<i>Electrodes</i> Ø x L [mm]	2.5 x 250	3.2 x 350	4.0 x 350
<i>Amperage</i> [A]	70 – 90	100 – 120	120 – 140

## Classifications

rutile-coated stick electrode, stainless

DIN 8555

EN 14700

E 3-UM-50-CTZ

E Z Fe3

## Characteristics and field of use

UTP 750 is suited for heat resistant buildups on hot working steels particularly exposed to metallic gliding wear and elevated thermal shock stress, such as diecast moulds for brass, aluminium and magnesium, hot-pressed mandrils, trimming tools, hot-shear blades, extruding tools, forging dies and hot flow pressing tools for steel. Due to the excellent metal-to-metal gliding properties, also suitable for buildups on guiding and gliding surfaces. Tempering resistant up to 650 °C, scale-resisting up to 900 °C, it can be nitrided and is stainless.

UTP 750 has excellent welding properties, a homogeneous, finely rippled seam and a self-lifting slag, good bead appearance.

Hardness of the pure weld deposit:

untreated	48 – 52 HRC
soft annealed 850 – 900 °C	approx. 35 HRC
hardened 1000 – 1150 °C / air	48 – 52 HRC
tempered 700 °C	approx. 40 HRC

## Typical analysis in %

C	Si	Mn	Cr	Mo	Ni	Co	Fe
0.2	0.5	0.2	11.5	4.5	1.0	12.5	balance

## Welding instructions

Clean welding area to metallic bright. Preheating temperature depends on the welding application (150 – 400 °C). On low-alloy steels at least 3 – 4 layers should be applied.

## Welding positions



Current type DC (+) / AC

## Form of delivery and recommended welding parameters

<i>Electrodes Ø x L [mm]</i>	2.5 x 250*	3.2 x 350*	4.0 x 350*
<i>Amperage [A]</i>	60 – 90	80 – 120	120 – 160

\*available on request

**UTP 7000**

anti-wear &amp; anti-corrosion

**Classifications**

rutile-basic-coated high efficiency electrode

DIN 8555

EN 14700

E 23-UM-200-CKTZ

E Z Ni 2

**Characteristics and field of use**

UTP 7000 is particularly suited for wear resisting cladding on working surfaces of hot working tools subject to thermal load, such as forging jaws, forging dies, forging saddles, hot piercing plugs, hot cutting tools, hot trimming tools, roll mandrils, hot moulding plugs.

UTP 7000 has excellent welding properties, a regular and finely rippled bead appearance due to spray arc. Very easy slag removal. The weld deposit is highly corrosion resistant, scale resistant and workhardening. Machinable with cutting tools.

Hardness of the pure weld deposit :                      approx. 220 HB  
after workhardening    approx. 450 HB

**Typical analysis in %**

C	Si	Mn	Cr	Mo	Ni	W	Co	Fe
0.04	0.3	0.9	16.0	17.0	balance	5.0	1.5	5.0

**Welding instructions**

Clean welding area, preheat tools to 350 – 400 °C and maintain this temperature during the whole welding process. Slow cooling in an oven. Hold stick electrode vertically and with a short arc. Select lowest possible amperage, in order to reduce dilution with the base metal. Cracks in the tool have to be gouged out completely and welded with UTP 7015 HL or UTP 068 HH. Final layers have to be welded with UTP 7000. Re-dry stick electrodes that have got damp for 2 h / 300 °C.

**Welding positions**

Current type DC (+) / AC

**Form of delivery and recommended welding parameters**

Electrodes Ø mm x L	2.5 x 350	3.2 x 350	4.0 x 350	5.0 x 450
Amperage [A]	80 – 100	100 – 120	130 – 160	180 – 220

**Classifications** rutilé-basic-coated high efficiency electrode

DIN 8555

EN 14700

E 23-UM-250-CKTZ

E Z Ni2

### Characteristics and field of use

UTP 7008 is particularly suited for wear resisting cladding on hot working tools subject to thermal load, such as forging saddles, forging jaws, forging dies, hot piercing plugs, hot cutting knives, hot trimming tools and hot press rams.

UTP 7008 has excellent welding properties, a homogeneous, finely rippled bead appearance due to the spray arc, very easy slag removal. The weld deposit is highly corrosion resistant, scale resistant and workhardening. Machinable with cutting tools.

Hardness of the pure weld deposit : approx. 260 HB  
workhardened approx. 500 HB

### Typical analysis in %

C	Si	Mn	Cr	Mo	Ni	V	W	Fe
0.04	0.5	1.3	16.0	16.0	balance	1.0	7.0	6.0

### Welding instructions

Clean welding area. Preheat tools to 350 – 400 °C, temperature should be maintained during the welding process. Slow cooling in oven. Hold stick electrode as vertically as possible and with a short arc. Select lowest possible amperage, in order to reduce dilution with the base metal. Re-dry stick electrodes that have got damp for 2 h / 300 °C.

### Welding positions

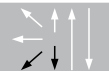

Current type DC (+) / AC

### Form of delivery and recommended welding parameters

<i>Electrodes Ø x L [mm]</i>	2.5 x 350	3.2 x 350	4.0 x 350
<i>Amperage [A]</i>	60 – 90	80 – 120	110 – 150

**UTP 7010**

anti-wear &amp; anti-corrosion

**Classifications**

rutile-coated stick electrode

EN 14700

DIN 8555

EZ Co1

E20-UM-250-CKTZ

**Characteristics and field of use**

UTP 7010 is suited to production and repair of hot-working tools subject to extreme temperatures, thermal shock, compression, impact and abrasion. Main application fields are hot dies, hot pressing blades, hot trimming tools and roll mandrils. Special applications are between-layer build-ups on workpieces in nuclear reactor engineering.

Welding properties and special properties of the weld deposit

UTP 7010 shows excellent welding properties, good weld pool control, regular bead appearance and easy slag removal. The weld deposit is highly corrosion- and scaling-resistant, has a high work-hardenability and is heat-resistant up to 900 °C. Machinable with cutting tools.

Hardness of the pure weld deposit:

As welded : approx. 230 HB

Work-hardened : approx. 450 HB

**Typical analysis in %**

C	Si	Mn	Cr	Ni	W	Co	Fe
0.1	0.5	1.2	21.0	11.0	14.0	balance	2.0

**Welding instructions**

Clean welding area, preheat tools to 350 – 400 °C and maintain this temperature during the whole welding process. Slow cooling in a furnace. Hold stick electrode vertically and with a short arc. Select lowest possible amperage in order to reduce dilution with the base metal. Re-dry damp stick electrodes for 2 h / 300 °C.

**Welding positions**

Current type DC (+) / AC

**Form of delivery and recommended welding parameters**

<i>Electrodes</i> Ø x L [mm]	3.2 x 350 mm
<i>Amperage</i> [A]	80 – 120

**UTP 7100**

anti-wear &amp; anti-corrosion

**Classifications**

high-efficiency stick electrode

EN 14700

DIN 8555

E Z Fe14

E 10-UM-65-GRZ

**Characteristics and field of use**

The high Cr-C-alloyed hardfacing stick electrode UTP 7100 is used for surfacings on parts made of carbon steel, cast steel or Mn-steel, which are subject to grinding wear, such as idlers, digging buckets, digging teeth, ploughshares, mixing wings and conveyor screws. On Mn-hard steels it is advisable to weld the building-up layers with UTP 630 or UTP 7200.

Hardness of the pure weld deposit: 60 – 63 HRC  
 First layer on S355: 55 HRC

**Typical analysis in %**

C	Cr	Fe
5.0	35.0	balance

**Welding instructions**

Hold stick electrode as vertically as possible and weld with a short arc. The weld deposit has high hardness values already in the first layer due to low dilution with the base metal.

**Welding positions**

Current type DC (+) / AC

**Form of delivery and recommended welding parameters**

<i>Electrodes Ø x L [mm]</i>	3.2 x 350	4.0 x 350	5.0 x 450
<i>Amperage [A]</i>	110 – 160	150 – 200	180 – 240

**Classifications** basic-coated, CrNi alloyed, Mn-hardsteel stick electrode

DIN 8555	EN 14700	AWS A5.13
~ E 7-UM-250-KP	EZ Fe9	~ E FeMn-C

**Characteristics and field of use**

UTP 7200 is predominantly suitable for tough and crack-resistant joinings and surfacings on parts of high Mn-steel subject to extreme impact, compression and shock. Build-ups on C-steel are also possible. The main application areas are the building industry, quarries and mines for surfacing worn high-Mn steel parts, e.g. excavator pins, buckets and teeth, mill hammers, crusher jaws, cones and beaters, impeller bars, railway building machinery, shunts, heart and cross pieces.

The high Mn-content produces a fully austenitic deposit. The deposit is highly work-hardening and hardens during service from originally 200 – 250 HB to 450 HB. Machining is possible with tung-stene carbide tools.

Hardness of the pure weld deposit  
 As welded: 200 – 250 HB  
 After work-hardening: 48 – 53 HRC

**Typical analysis in %**

C	Mn	Ni	Cr	Fe
0.7	13.0	4.0	4.5	balance

**Welding instructions**

Hold stick electrode as vertically as possible. Weld at a low temperature and keep interpass temperature below 250 °C. It is recommended to weld short beads and to allow for continuous cooling during welding; you may also place the workpiece in a cold water bath and have only the welding area stand out of the water.

**Welding positions**

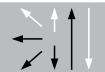

Current type DC (+) / AC

**Approvals**

DB (No. 20.138.08)

**Form of delivery and recommended welding parameters**

<i>Electrodes Ø x L [mm]</i>	3.2 x 350	4.0 x 450	5.0 x 450
<i>Amperage [A]</i>	110 – 140	150 – 180	180 – 210



**Classifications** basic-coated Chromium alloyed Mn-steel stick electrode

DIN 8555

EN 14700

E 7-UM-250-KPR

E Fe9

## Characteristics and field of use

UTP BMC is suitable for claddings on parts subject to highest pressure and shock in combination with abrasion. Surfacing can be made on ferritic steel as well as austenitic hard Mn-steel and joints of hard Mn-steel can be welded. Main application fields are in the mining- and cement industry, crushing plants, rail lines and steel works, where working parts are regenerated, such as breaker jaws, paving breakers and beating arms, frogs and cross pieces, roll shafts, flight pushers and wobbler drives.

Fully austenitic structure. Due to the addition of Cr, increased resistance against friction and corrosion. Very high workhardening and high toughness.

Hardness of the pure weld deposit

After welding:

approx. 260 HB

After work hardening:

48 – 53 HRC

## Typical analysis in %

C	Si	Mn	Cr	Fe
0.6	0.8	16.5	13.5	balance

## Welding instructions

Hold the stick electrode nearly vertical. Welding should be done at low temperature. Interpass temperature should not exceed 250 °C. It is therefore recommended to weld short beads and to allow for continuous cooling or to place the workpiece in a cold water bath with only the welding area sticking out of water. Re-drying: 2 h / 300 °C

## Welding positions



Current type DC (+) / AC

## Form of delivery and recommended welding parameters

<i>Electrodes</i> Ø x L [mm]	3.2 x 350	4.0 x 450	5.0 x 450
<i>Amperage</i> [A]	110 – 150	140 – 190	190 – 240

**UTP CELSIT 701**

anti-wear &amp; anti-corrosion

**Classifications** rutile-coated stick electrode on Cobalt base, core wire alloyed

DIN 8555

EN 14700

AWS A5.13

E 20-UM-55-CSTZ

E Co3

E CoCr-C

**Characteristics and field of use**

UTP CELSIT 701 is suited for highly wear-resistant hardfacings on parts subject to severe abrasion in combination with corrosion and high temperatures up to 900 °C, such as working parts in the chemical industry, running and sealing faces on fittings, valve seats and cones for combustion engines, cutting and crushing tools, hot working tools exposed to severe stresses without thermal shock, milling, mixing and drilling tools.  
Excellent gliding characteristics, good polishability, slightly magnetic.

Properties of the weld metal

Machining by grinding or with tungsten carbide cutting tools.

Welding properties

UTP CELSIT 701 has excellent welding properties, a homogeneous, finely rippled seam due to spray arc and very easy slag removal.

Hardness of the pure weld metal

54 – 56 HRC

Hardness at 600 °C

approx. 42 HRC

Hardness at 800 °C

approx. 34 HRC

**Typical analysis in %**

C	Cr	W	Co
2.3	32.0	13.0	balance

**Welding instructions**

Clean welding area, preheating temperature 500 – 600 °C, very slow cooling. Hold stick electrode vertically with a short arc and lowest possible amperage. Re-dry damp stick electrodes for 2 h / 300 °C.

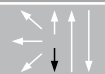
**Welding positions**

Current type DC (+) / AC

**Form of delivery and recommended welding parameters**

<i>Electrodes</i> Ø x L [mm]	3.2 x 350	4.0 x 350
<i>Amperage</i> [A]	70 – 110	90 – 130

# UTP CELSIT 706

anti-wear & anti-corrosion

**Classifications** rutile-coated stick electrode on Cobalt base, core wire alloyed

DIN 8555

EN 14700

AWS A5.13

E 20-UM-40-CSTZ

E Z Co2

E CoCr-A

## Characteristics and field of use

UTP CELSIT 706 is used for hardfacing on parts subject to a combination of erosion, corrosion, cavitation, impact, pressure, abrasion and high temperatures up to 900 °C, such as tight surfaces on fittings, valve seats and cones for combustion engines, gliding surfaces metal-metal, highly stressed hot working tools without thermal shock, milling mixers and drilling tools.

Excellent gliding characteristics, easy polishability, good toughness, nonmagnetic. Machining by grinding or with tungsten carbide cutting tools.

UTP CELSIT 706 has excellent welding properties and a homogenous, finely rippled seam due to spray arc. Very easy slag removal.

Hardness of the pure weld deposit	40 – 42 HRC
Hardness at 500 °C	approx. 30 HRC
Hardness at 700 °C	approx. 160 HB

## Typical analysis in %

C	Cr	W	Co
1.1	27.5	4.5	balance

## Welding instructions

Clean welding area, preheating temperature 450 – 600 °C, very slow cooling. Hold stick electrode vertically and with a short arc and lowest possible amperage. Re-dry stick electrodes that have become damp for 2 h / 300 °C.

## Welding positions



Current type DC (+) / AC

## Form of delivery and recommended welding parameters

<i>Electrodes Ø x L [mm]</i>	3.2 x 350	4.0 x 350	5.0 x 350*
<i>Amperage [A]</i>	70 – 110	90 – 130	110 – 150

\*available on request

**UTP CELSIT 712**

anti-wear &amp; anti-corrosion

**Classifications** rutile-coated stick electrode on Cobalt base, core wire alloyed

EN 14700

AWS A5.13

DIN 8555

E Co3

E CoCr-B

E 20-UM-50-CSTZ

**Characteristics and field of use**

UTP CELSIT 712 is used for highly wear-resistant hardfacings on parts subject to a combination of abrasion, erosion, cavitation, corrosion, pressure and high temperatures up to 900 °C, such as running, sealing and gliding faces on fittings and pumps; tools for wood, paper, plastic; shredding tools; highly stressed hot-working tools not subject to thermal shock.

Properties of the weld metal

Machining by grinding or with tungsten carbide cutting tools.

Welding properties

UTP CELSIT 712 has excellent welding properties and a homogeneous, finely rippled seam. Very easy slag removal.

Hardness of the pure weld deposit

Hardness at RT:

48 – 50 HRC

Hardness at 500 °C:

approx. 40 HRC

Hardness at 700 °C:

approx. 33 HRC

**Typical analysis in %**

C	Cr	W	Co
1.6	29.0	8.5	balance

**Welding instructions**

Clean welding area, preheating temperature 500 / 600 °C, very slow cooling. Hold stick electrode vertically, weld with a short arc and lowest possible amperage. Re-dry damp stick electrodes for 2 h / 300 °C.

**Welding positions**

Current type DC (+) / AC

**Form of delivery and recommended welding parameters**

<i>Electrodes</i> Ø x L [mm]	3.2 x 350	4.0 x 350
<i>Amperage</i> [A]	70 – 110	90 – 130

**Classifications** rutile-coated stick electrode on Cobalt base, core wire alloyed

DIN 8555 EN 14700 AWS A5.13

E 20-UM-350-CTZ E Co1 E CoCr-E

## Characteristics and field of use

UTP CELSIT 721 is used for crack-resistant hardfacings on parts subject to a combination of impact, pressure, abrasion, corrosion and high temperatures up to 900 °C, such as running and sealing faces on gas, water, steam and acid fittings and pumps, valve seats and cones for combustion engines, working parts in gas and power plants, hot-working tools with changing thermal load.

Excellent gliding characteristics, good polishability and toughness, highly work-hardening, nonmagnetic, machinable with cutting tools.

UTP CELSIT 721 has excellent welding properties and a homogenous, finely-rippled seam. Very easy slag removal.

Hardness of the pure weld metal: 31 – 37 HRC  
 Work-hardened: approx. 45 HRC  
 Hardness at 600 °C: approx. 240 HB

## Typical analysis in %

C	Cr	Mo	Ni	Co
0.3	31.0	5.0	3.5	balance

## Welding instructions

Clean welding area, preheating temperature 150 – 400 °C, depending on the size of the work piece and the base material. Slow cooling. Hold stick electrode vertically and with a short arc and lowest possible amperage. Re-dry damp stick electrodes for 2 h / 300 °C

## Welding positions



Current type DC (+) / AC

## Form of delivery and recommended welding parameters

Electrodes Ø x L [mm]	3.2 x 350	4.0 x 350
Amperage [A]	80 – 120	110 – 140

**UTP CHRONOS**

anti-wear

**Classifications**

Basic-coated high-Mn-steel stick electrode

DIN 8555

EN 14700

E 7-UM-200-KP

E Fe9

**Characteristics and field of use**

UTP CHRONOS is suitable for build-ups on high-Mn-steel of the same and similar nature and on C-steels. Main applications are the re-conditioning of crusher jaws and cones, excavator teeth and buckets, edge mills and runners, railway units.

Fully austenitic structure, tough, with strong tendency to workhardening under pressure and shock. Machinable only with tungsten carbide tools or by grinding.

Hardness of the pure weld deposit:

As-welded condition: approx. 220 HB

After workhardening: 50 – 55 HRC

**Typical analysis in %**

C	Si	Mn	Fe
0.9	0.8	13.0	balance

**Welding instructions**

Hold stick electrode as vertically as possible. Welding should be done at lowest possible temperature. Interpass temperature should not exceed 250 °C. It is therefore recommended to weld short beads and to allow for intermediate cooling, or to place the workpiece in a cold-water bath, having only the weld area stick out. Damp electrodes should be re-dried for 2 h / 300 °C.

**Welding positions**

Current type DC (+) / AC

**Approvals**

DB (No. 20.138.05)

**Form of delivery and recommended welding parameters**

<i>Electrodes</i> Ø x L [mm]	3.2 x 450	4.0 x 450
<i>Amperage</i> [A]	120 – 150	150 – 180

## Classifications

basic-coated stick electrode

DIN 8555

EN 14700

E 1-UM-250

E Fe1

## Characteristics and field of use

UTP DUR 250 is used for surfacing on parts, where a tough and easily machinable deposit is required, such as rails, gear wheels, shafts and other parts on farming and building machineries. Also suitable as cushion and filler layer on non-alloyed and low-alloyed steels and cast steels.

Hardness of the pure weld deposit  
1 layer on steel with C = 0.5%

approx. 270 HB  
approx. 320 HB

UTP DUR 250 has a very good resistance against compression and rolling strain. The weld metal is easily machinable.

## Typical analysis in %

C	Si	Mn	Cr	Fe
0.15	1.1	1.2	0.8	balance

## Welding instructions

Hold stick electrode as vertically as possible and with a short arc. Preheat heavy parts and higher-carbon steel qualities to 150 – 300 °C. Re-dry stick electrodes that have got damp for 2 h / 300 °C.

## Welding positions



Current type DC (+) / AC

## Form of delivery and recommended welding parameters

<i>Electrodes Ø x L [mm]</i>	3.2 x 450	4.0 x 450	5.0 x 450	6.0 x 450*
<i>Amperage [A]</i>	100 – 140	140 – 180	180 – 230	230 – 300

\*available on request

**UTP DUR 350**

anti-wear

**Classifications**

basic-coated stick electrode

DIN 8555

EN 14700

E 1-UM-350

E Fe1

**Characteristics and field of use**

UTP DUR 350 is particularly suited for wear resistant surfacings on Mn-Cr-V alloyed parts, such as frogs, track rollers, chain support rolls, sprocket wheels, guide rolls etc. The deposit is still machinable with tungstene carbide tools.

UTP DUR 350 has a very good resistance against compression and rolling strain in combination with slight abrasion. The weld metal is machinable with tungstene carbide tools.

Hardness of the pure weld deposit  
1 layer on steel with C = 0.5 %

approx. 370 HB  
approx. 420 HB

**Typical analysis in %**

C	Si	Mn	Cr	Fe
0.2	1.2	1.4	1.8	balance

**Welding instructions**

Hold stick electrode as vertically as possible and with a short arc. Preheat heavy parts and higher-tensile steels to 250 – 350 °C. Stick electrodes that have got damp should be re-dried for 2 h / 300 °C.

**Welding positions**

Current type DC (+) / AC

**Approvals**

DB (No. 82.138.03)

**Form of delivery and recommended welding parameters**

<i>Electrodes</i> Ø x L [mm]	3.2 x 450	4.0 x 450	5.0 x 450
<i>Amperage</i> [A]	100 – 140	140 – 180	180 – 230



**Classifications**

basic-coated hardfacing stick electrode

DIN 8555

EN 14700

E 6-UM-60

E Fe8

**Characteristics and field of use**

UTP DUR 600 is universally applicable for cladding on parts of steel, cast steel and high Mn-steel, subject simultaneously to abrasion, impact and compression. Typical application fields are the earth moving and stone treatment industry, e.g. excavator teeth, bucket knives, crusher jaws and cones, mill hammers etc., but also for cutting edges on cold cutting tools.

Hardness of the pure weld deposit	56 – 58 HRC
After soft – annealing 780 – 820 °C / oven	approx. 25 HRC
After hardening 1000 – 1050 °C / oil	approx. 60 HRC
1 layer on high Mn-steel	approx. 22 HRC
2 layers on high Mn-steel	approx. 40 HRC

UTP DUR 600 has excellent welding properties due to a quiet arc, an even flow and a good weld build-up, easy slag removal. Machining of the weld metal possible by grinding.

**Typical analysis in %**

C	Si	Mn	Cr	Fe
0.5	2.3	0.4	9.0	balance

**Welding instructions**

Hold stick electrode as vertically as possible and with a short arc. Preheat heavy parts and high-tensile steels to 200 – 300 °C. On high Mn-steel, cold welding (max. 250 °C) is recommended, if necessary, intermediate cooling. On parts tending to hardening cracks, a cushion layer with UTP 630 is welded. UTP 630 should also be used for welding cracks under hardfacings. If more than 3 – 4 layers are needed, apply the softer stick electrodes UTP DUR 250 or UTP DUR 300 for build-up. Re-dry damp stick electrodes for 2h / 300 °C.

**Welding positions**

Current type DC (+) / AC

**Approvals**

DB (No. 20.014.23)

**Form of delivery and recommended welding parameters**

<i>Electrodes Ø x L [mm]</i>	2.5 x 300	3.2 x 350	4.0 x 450	5.0 x 450
<i>Amperage [A]</i>	80 – 100	100 – 140	140 – 180	180 – 210

**UTP DUR 650 Kb**

anti-wear

**Classifications**

basic-coated hardfacing stick electrode

DIN 8555

EN 14700

E 6-UM-60

E Fe8

**Characteristics and field of use**

UTP DUR 650 Kb is suitable for cladding structural parts subject to abrasion combined with impact. The main applications are tools in the earth moving industry and crushing plants as well as cold and hot working tools. The deposit is only machinable by grinding.

UTP DUR 650 Kb is a martensitic alloy. The stick electrode is suited in impact an pressure stress situations. Machining of the weld metal only by grinding.

Hardness of the pure weld deposit

58 – 60 HRC

1 layer on high Mn-steel

approx. 24 HRC

2 layers on high Mn-steel

approx. 45 HRC

**Typical analysis in %**

C	Si	Mn	Cr	Mo	Nb	Fe
0.5	0.8	1.3	7.0	1.3	0.5	balance

**Welding instructions**

Hold stick electrode as vertically as possible, keep a short arc. Preheating of non-alloyed steels is not necessary. Preheat heavy parts and high-tensile base materials to 250 – 350 °C. If more than 3 – 4 layers are needed, apply the softer stick electrodes UTP DUR 250 or UTP DUR 300 for buildup. On high Mn-steel, UTP BMC should be used. Re-dry stick electrodes that have got damp for 2 h / 300 °C.

**Welding positions**

Current type DC (+) / AC

**Form of delivery and recommended welding parameters**

Electrodes $\varnothing \times L$ [mm]	3.2 x 450	4.0 x 450	5.0 x 450	6.0 x 450*
Amperage [A]	80 – 110	130 – 170	160 – 200	190 – 230

\*available on request

**Classifications** basic-coated stick electrode against cavitation wear, stainless

DIN 8555

EN 14700

E 5-UM-250-CKZT

EZ Fe9

### Characteristics and field of use

UTP HydroCav is suitable for wear-resistant surfacings with high resistance to cavitation, corrosion, pressure and impact, especially in the construction of water turbines and pumps. Thanks to a high work-hardening rate, the weld deposit will double its hardness values under impact stress. The main application field is surfacing of soft martensitic 13 / 4 CrNi-steels on Kaplan turbine blades.

UTP HydroCav has good welding properties and is weldable in all positions, except vertical-down. It shows a stable arc, an even weld build-up and easy slag removal.

Hardness of the pure weld deposit:

as-welded:

approx. 21 HRC

after work-hardening:

approx. 50 HRC

### Typical analysis in %

C	Si	Mn	Cr	Ni	Co	Fe
0.2	0.7	10.0	20.0	0.15	13.0	balance

### Welding instructions

Clean welding area thoroughly to a metallic bright finish. The interpass temperature should not exceed 250 °C. Preheating of heavy work pieces to 80 – 100 °C is recommended. Hold stick electrode vertically and weld with short arc. Re-baking: 2h / 300 °C

### Welding positions



Current type DC (+) / AC

### Form of delivery and recommended welding parameters

<i>Electrodes</i> Ø x L [mm]	2.5 x 250	3.2 x 350	4.0 x 350
<i>Amperage</i> [A]	70 – 90	90 – 120	120 – 150

**Classifications** rutile-basic-coated hardfacing stick electrode

DIN 8555	EN 14700	AWS A5.13
E 10-UM-60-GRZ	EZ Fe14	~ E FeCr-A 1

**Characteristics and field of use**

UTP LEDURIT 61 is suited for highly wear resistant claddings on parts subject to strong grinding abrasion combined with medium impact, such as conveyor screws, scraper blades, digging teeth, mixer wings, sand pumps. Also as a final layer on crusher jaws.

**Welding properties**

UTP LEDURIT 61 has excellent welding characteristics and a very easy slag removal. The homogeneous and finely rippled seam surface does, for most applications, not require any finishing by grinding.

Hardness of the pure weld deposit	approx. 60 HRC
1 layer on steel with C = 0.15 %	approx. 55 HRC
1 layer on high Mn-steel	approx. 52 HRC

**Typical analysis in %**

C	Si	Cr	Fe
3.2	1.3	32.0	balance

**Welding instructions**

Hold stick electrode as vertically as possible, keep a short arc. Preheating is in general not necessary. On multipass-applications a cushion layer with UTP 630 is recommended in order to prevent hardening cracks in the weld deposit. Re-dry stick electrodes that have got damp for 2 h / 300 °C.

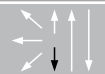
**Welding positions**

Current type DC (+) / AC

**Form of delivery and recommended welding parameters**

<i>Electrodes</i> Ø x L [mm]	2.5 x 350	3.2 x 350	4.0 x 450	5.0 x 450
<i>Amperage</i> [A]	80 – 100	90 – 130	130 – 180	140 – 190

<b>Classifications</b>	high-efficiency stick electrode without slag
DIN 8555	EN 14700
E 10-UM-65-GRZ	E Fe16

## Characteristics and field of use

UTP LEDURIT 65 is suited for highly abrasion resistant claddings on parts subject to extreme sliding mineral abrasion, also at elevated temperatures up to 500°C. The extremely high abrasion resistance is reached by the very high content of special carbides (Mo, V, W, Nb). Main application fields are surfacings on earth moving equipment, working parts in the cement and brick industry as well as in steel mills for radial breakers and revolving-bar screens of sintering plants.

UTP LEDURIT 65 has an even droplet transfer in the spray arc. The smooth welding bead is without slag covering. In general there is no need for any finishing by grinding.

Recovery approx. 265%.

Hardness of the pure weld deposit	approx. 65 HRC
1 layer on steel with C = 0.15%	approx. 58 HRC
1 layer on high Mn-steel	approx. 55 HRC

## Typical analysis in %

C	Cr	Mo	Nb	V	W	Fe
4.5	23.5	6.5	5.5	1.5	2.2	balance

## Welding instructions

Hold stick electrode as vertically as possible, keep a short arc. For multipass applications a cushion layer with UTP 630 is recommended. Re-dry stick electrodes that have got damp for 2 h / 300°C.

## Welding positions



Current type DC (+) / AC

## Form of delivery and recommended welding parameters

<i>Electrodes Ø x L [mm]</i>	3.2 x 350	4.0 x 450	5.0 x 450
<i>Amperage [A]</i>	110 – 150	140 – 200	190 – 250

## List of contents

### GTAW – TIG rods

<b>Description of the GTAW process</b>	<b>93</b>
<b>TIG rods for repair of cracked material</b>	<b>94</b>
1. Unalloyed and low alloyed steels	94
2. Stainless steels	96
3. Nickel alloys	106
4. Cast iron	121
5. Copper alloys	123
6. Tool steels	133
7. Cobalt-based alloys	141

## Description of the GTAW process

*GTAW = Gas Tungsten Arc Welding*  
*TIG = Tungsten-Inert-Gas*

**In TIG welding an electric arc is struck between a tungsten electrode, which does not melt away, and the workpiece (contact or high-frequency ignition).**

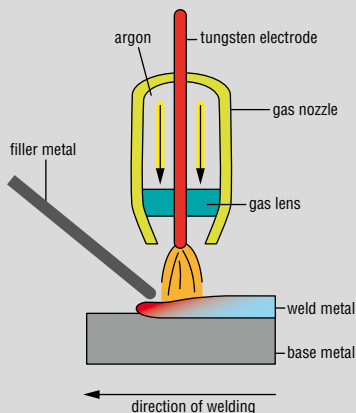

If a welding consumable is needed, it is supplied as a cold wire, and is melted in the arc in front of the molten pool. The electrode, the arc and the molten pool are protected from the effects of the atmosphere by an inert shielding gas – argon is usually used, or, more rarely, the relatively expensive helium or a mixture of gases. The welding equipment consists of a source of electrical current (DC or AC) and a welding torch connected through a hose assembly. This assembly contains the cable for the welding current, the supply of shielding gas, the control line and, in larger equipment, a feed and return line for cooling water.

The decoupling of the supply of electricity from the welding consumables, which is typical for TIG welding, allows highly individual adjustment of the parameters, so leading to very clean, high-quality welded joints for root passes and position welding. There is hardly any splatter and only a little welding fume, in addition to which lack of fusion, undercuts and pores are easily avoided. TIG welding is therefore used wherever weld seams of particularly high quality are needed, such as in the construction of pipelines and apparatus, power station building, aerospace engineering, and in the chemical and food industries. The TIG technique can be applied manually or mechanically (whether semi or fully automatic), and can be used to process any metal that is suitable for welding.

## TIG rods for repair of cracked material

### 1. Unalloyed and low alloyed steels

Product name	EN ISO		AWS		Mat. - No.	Page
UTP A 641	21952-A	W CrMo1Si	A5.28	ER 80S-G [ER 80S-B2(mod.)]	1.7339	95

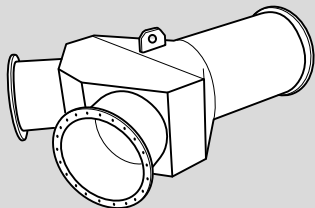

*Piping*

UTP A 641



## Classifications

TIG rod

EN ISO 21952-A	AWS A5.28	Material-No.
W CrMo1Si	ER80S-G [ER80S-B2(mod.)]	1.7339

## Characteristics and field of use

Welding rod for the welding with argon. Suitable for manufacturing creep resistant steels in boiler, tank, pipeline and nuclear reactor construction.

## Base materials

1.7335 – 13CrMo4-5, ASTM A193 Gr. B7;  
 1.7357 – G17CrMo5-5 – A217 Gr. WC6;  
 A335 Gr. P11 u. P12

## Typical analysis of rod and wire in %

C	Si	Mn	Cr	Mo
0.1	0.6	1.0	1.1	0.5

## Mechanical properties of the weld metal

Heat-treatment	Yield strength $R_{p0.2}$	Tensile strength $R_m$	Elongation $A$	Impact strength $K_V$
	MPa	MPa	%	J [RT]
annealed	450	560	22	90

## Approvals

TÜV (No. 00906), DB (No. 42.132.44)

## Form of delivery

Rod diameter x length [mm]	Current type	Shielding gas (EN ISO 14175)
2.0 x 1000	DC (-)	I 1
2.4 x 1000	DC (-)	I 1
3.2 x 1000	DC (-)	I 1

## TIG rods for repair of cracked material

### 2. Stainless steels

Product name	EN ISO	AWS	Mat. - No.	Page
UTP A 63	14343-A W 18 8 Mn	A5.9 ER 307 (mod.)	1.4370	97
UTP A 68	14343-A W 19 9 Nb Si	A5.9 ER 347 (Si)	1.4551	98
UTP A 68 LC	14343-A W 19 9 L (Si)	A5.9 ER 308 L (Si)	1.4316	99
UTP A 68 Mo	14343-A W 19 12 3 Nb (Si)	A5.9 ER 318 (Si)	1.4576	100
UTP A 68 MoLC	14343-A W 19 12 3 L (Si)	A5.9 ER 316 L (Si)	1.4430	101
UTP A 651	14343-A W 29 9	A5.9 ER 312	1.4337	102
UTP A 6635	14343-A W 13 4 (Si)	A5.9 ~ ER 410 NiMo	1.4351	103
UTP A 6808 Mo	14343-A W 22 9 3 N L	A5.9 ER 2209	~ 1.4462	104
UTP A 6824 LC	14343-A W 23 12 L (Si)	A5.9 ER 309 L (Si)	1.4332	105

#### Solution examples

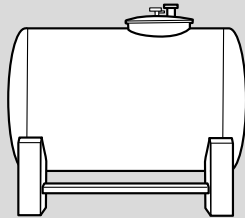

*Vessel*

UTP A 68 LC

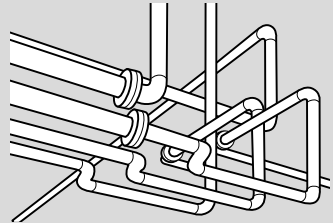

*Piping*

UTP A 68 MoLC

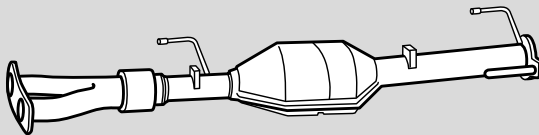

*Catalytic converter*

UTP A 63

## Classifications

TIG rod

EN ISO 14343-A	AWS A5.9	Material-No.
W 18 8 Mn	ER 307 (mod.)	1.4370

## Characteristics and field of use

UTP A 63 is suitable for particularly crack resistant joining and surfacing of high-strength ferritic and austenitic steels, hard manganese steels and cold-tough steels, as cushioning layer under hard alloys, dissimilar metal joints.

The weld metal of UTP A 63 is scale resistant up to 850 °C, cold-tough to – 110 °C. Work hardening.

Hardness of the pure weld metal: approx. 200 HB

## Typical analysis in %

C	Si	Mn	Cr	Ni	Fe
0.08	0.8	6.5	19.5	9.0	balance

## Mechanical properties of the weld metal

<i>Yield strength <math>R_{p0.2}</math></i>	<i>Tensile strength <math>R_m</math></i>	<i>Elongation A</i>
<i>MPa</i>	<i>MPa</i>	<i>%</i>
> 370	> 600	> 30

## Welding instructions

Clean weld area thoroughly. Thick walled, ferritic elements have to be preheated to approx. 150 – 250 °C.

## Approvals

TÜV (No. 04097)

## Form of delivery and recommended welding parameters

<i>Rod diameter x length [mm]</i>	<i>Current type</i>	<i>Shielding gas (EN ISO 14175)</i>
1.2 x 1000*	DC (–)	I 1
1.6 x 1000	DC (–)	I 1
2.0 x 1000	DC (–)	I 1
2.4 x 1000	DC (–)	I 1
3.2 x 1000	DC (–)	I 1

\*available on request

## Classifications

TIG rod

EN ISO 14343-A

AWS A5.9

Material-No.

W 19 9 Nb Si

ER 347 (Si)

1.4551

## Characteristics and field of use

UTP A 68 is suitable for joining and surfacing in chem. apparatus and vessel construction for working temperatures of  $-196^{\circ}\text{C}$  up to  $400^{\circ}\text{C}$ .

## Base materials

1.4550	X6 CrNiNb 18-10
1.4541	X6CrNiTi 18-10
1.4552	G-X5 CrNiNb 18-10
1.4311	X2 CrNiN 18-10
1.4306	X2 CrNi 19-11

AISI 347, 321, 302, 304, 3046, 304LN  
ASTM A 296 Gr. CF 8 C, A 157 Gr. C 9

## Typical analysis in %

C	Si	Mn	Cr	Ni	Nb	Fe
0.05	0.4	1.5	19.5	9.5	0.55	balance

## Mechanical properties of the weld metal

Yield strength $R_{p0.2}$	Tensile strength $R_m$	Elongation A	Impact strength $K_v$
MPa	MPa	%	J [RT]
420	600	30	100

## Welding instructions

Degrease and clean weld area thoroughly (metallic bright). Preheating and post heat treatment are usually not necessary.

## Approvals

TÜV (No. 04866)

## Form of delivery and recommended welding parameters

Rod diameter x length [mm]	Current type	Shielding gas (EN ISO 14175)
1.0 x 1000*	DC (-)	I 1
1.6 x 1000	DC (-)	I 1
2.0 x 1000	DC (-)	I 1
2.4 x 1000	DC (-)	I 1
3.2 x 1000*	DC (-)	I 1

\*available on request

## Classifications

TIG rod

EN ISO 14343-A

AWS A5.9

Material-No.

W 19 9 L (Si)

ER 308 L (Si)

1.4316

## Characteristics and field of use

UTP A 68 LC is suitable for joining and surfacing in chem. apparatus and vessel construction for working temperatures of  $-196^{\circ}\text{C}$  up to  $350^{\circ}\text{C}$ .

## Base materials

1.4301	X5 CrNiNi 18-10
1.4306	X2 CrNi 19-11
1.4311	X2 CrNiN 18-10
1.4312	G-X10 CrNi 18-8
1.4541	X6 CrNiTi 18-10
1.4546	X5 CrNiNb 18-10
1.4550	X6 CrNiNb 18-10

AISI 304; 304L; 302; 321; 347

ASTM A 1576 Gr. C 9; A 320 Gr. B 8 C or D

## Typical analysis in %

C	Si	Mn	Cr	Ni	Fe
0.02	0.4	1.5	20.0	10.0	balance

## Mechanical properties of the weld metal

Yield strength $R_{p0.2}$	Tensile strength $R_m$	Elongation $A$	Impact strength $K_V$
MPa	MPa	%	J [RT]
400	600	35	100

## Approvals

TÜV (No. 05831)

## Form of delivery and recommended welding parameters

Rod diameter x length [mm]	Current type	Shielding gas (EN ISO 14175)
1.0 x 1000*	DC (-)	I 1
1.2 x 1000*	DC (-)	I 1
1.6 x 1000	DC (-)	I 1
2.0 x 1000	DC (-)	I 1
2.4 x 1000	DC (-)	I 1
3.2 x 1000	DC (-)	I 1

\*available on request

## Classifications

TIG rod

EN ISO 14343-A	AWS A5.9	Material-No.
W 19 12 3 Nb (Si)	ER 318 (Si)	1.4576

## Characteristics and field of use

UTP A 68 Mo is applicable for joinings and surfacings of stabilized, corrosion resistant CrNiMo steels of similar nature in the construction of chemical apparatus and vessels up to working temperatures of 120 °C up to 400 °C.

## Base materials

1.4401	X5 CrNiMo 17-12-2
1.4404	X2 CrNiMo 17-12-2
1.4435	X2 CrNiMo 18-14-3
1.4436	X3 CrNiMo 17-13-3
1.4571	X6 CrNiMoTi 17-12-2
1.4580	X6 CrNiMoNb 17-12-2
1.4583	X10 CrNiMoNb 18-12
1.4409	G-X2 CrNiMo 19-112

UNS S31653; AISi 361L; 316Ti; 316Cb

## Typical analysis in %

C	Si	Mn	Cr	Mo	Ni	Nb	Fe
0.03	0.4	1.5	19.0	2.8	11.5	0.55	balance

## Mechanical properties of the weld metal

Yield strength $R_{p0.2}$	Tensile strength $R_m$	Elongation $A$	Impact strength $K_v$
MPa	MPa	%	J [RT]
460	680	35	100

## Welding instructions

Degrease and clean weld area thoroughly (metallic bright). Preheating and post heat treatment are usually not necessary.

## Approvals

TÜV (No. 04868)

## Form of delivery and recommended welding parameters

Rod diameter x length [mm]	Current type	Shielding gas (EN ISO 14175)
1.6 x 1000	DC (-)	I 1
2.0 x 1000	DC (-)	I 1
2.4 x 1000	DC (-)	I 1
3.2 x 1000	DC (-)	I 1
4.0 x 1000*	DC (-)	I 1

\*available on request

## Classifications

TIG rod

EN ISO 14343-A	AWS A5.9	Material-No.
W 19 12 3 L (Si)	ER 316 L (Si)	1.4430

## Characteristics and field of use

UTP A 68 MoLC is used for joining and surfacing of low-carbon, corrosion resistant CrNiMo steels exposed to high corrosion for working temperatures up to +350 °C. Application fields are chemical apparatus and vessels.

## Base materials

Material-No.	EN Symbol
1.4401	X5 CrNiMo 17-12-2
1.4404	X2 CrNiMo 17-12-2
1.4435	X2 CrNiMo 18-14-3
1.4436	X3 CrNiMo 17-13-3
1.4571	X6 CrNiMoTi 17-12-2
1.4580	X6 CrNiMoNb 17-12-2
1.4583	X10 CrNiMoNb 18-12
1.4409	GX2 CrNiMo 19-11-2
	S31653, AISi 316 L, 316 Ti, 316 Cb

## Typical analysis in %

C	Si	Mn	Cr	Mo	Ni	Fe
0.02	0.4	1.5	18.5	2.8	12.0	balance

## Mechanical properties of the weld metal

Yield strength $R_{p0.2}$	Tensile strength $R_m$	Elongation $A$	Impact strength $K_V$
MPa	MPa	%	J [RT]
420	600	35	100

## Welding instructions

Degrease and clean weld area thoroughly (metallic bright). Preheating and post heat treatment are usually not necessary.

## Approvals

TÜV (No. 05832), GL

## Form of delivery and recommended welding parameters

Rod diameter x length [mm]	Current type	Shielding gas (EN ISO 14175)
1.6 x 1000	DC (-)	I 1
2.0 x 1000	DC (-)	I 1
2.4 x 1000	DC (-)	I 1
3.2 x 1000	DC (-)	I 1
4.0 x 1000*	DC (-)	I 1

\*available on request

## Classifications

TIG rod

EN ISO 14343-A

AWS A5.9

Material-No.

W 29 9

ER 312

1.4337

## Characteristics and field of use

UTP A 651 is suitable for joining and surfacing of steels of difficult weldability, repair of hot and cold working steels, cushioning layers.

The weld metal of UTP A 651 is scale resistant up to 1150 °C. Crack and wear resistant, stainless and work hardening.

Hardness of the pure weld metal: approx. 240 HB

## Typical analysis in %

C	Si	Mn	Cr	Ni	Fe
0.1	0.4	1.6	30.0	9.0	balance

## Mechanical properties of the weld metal

Yield strength $R_{p0.2}$	Tensile strength $R_m$	Elongation $A$	Impact strength $K_v$
MPa	MPa	%	J [RT]
650	750	25	27

## Welding instructions

Clean weld area thoroughly. High carboned and solid work pieces depending on shape and size have to be preheated up to 150-250 °C. Steady guidance during welding process.

## Form of delivery and recommended welding parameters

Rod diameter x length [mm]	Current type	Shielding gas (EN ISO 14175)
1.2 x 1000	DC (-)	I 1
1.6 x 1000	DC (-)	I 1
2.0 x 1000	DC (-)	I 1
2.4 x 1000	DC (-)	I 1
3.2 x 1000	DC (-)	I 1



## Classifications

TIG rod

EN ISO 14343-A	AWS A5.9	Material-No.
W 13 4 (Si)	~ ER 410 NiMo	1.4351

## Characteristics and field of use

UTP A 6635 is used for joining and building up on identical and similar martensitic CrNi cast steels for the water turbine- and compressor construction with steels.

The weld deposit of UTP A 6635 is stainless and corrosion resistant as 13 %-Cr(Ni)-steels. It presents a high resistance to corrosion fatigue.

## Base materials

1.4317	G-X4 CrNi 13-4
1.4313	X3 CrNiMo 13-4
1.4351	X3 CrNi 13-4
1.4414	G-X4 CrNiMo 13-4

ACI Gr. CA6NM

## Typical analysis in %

C	Si	Mn	Cr	Mo	Ni	Fe
0.03	0.7	0.7	13.5	0.55	4.5	balance

## Mechanical properties of the weld metal

Yield strength $R_{p0.2}$	Tensile strength $R_m$	Elongation A	Impact strength $K_V$
MPa	MPa	%	J [RT]
> 600	> 800	15	> 40

## Welding instructions

For similar materials up to 10 mm wall thickness, preheating is not necessary. From 10 mm wall thickness and up, preheating at 100 – 150 °C should be provided.

## Approvals

TÜV (No. 10434)

## Form of delivery and recommended welding parameters

Rod diameter x length [mm]	Current type	Shielding gas (EN ISO 14175)
2.0 x 1000*	DC (-)	I 1
2.4 x 1000*	DC (-)	I 1

\*available on request

## Classifications

TIG rod

EN ISO 14343-A

AWS A5.9

Material-No.

W 22 9 3 N L

ER 2209

~ 1.4462

## Characteristics and field of use

UTP A 6808 Mo is used for joining and surfacing of corrosion resistant steels as well as cast steel with austenitic-ferritic structure (Duplex steel). Working temperature: up to 250 °C

The weld deposit of UTP A 6808 Mo has an excellence resistance against pitting and stress corrosion cracking next to high strength- and toughness-properties. Very good weld- and flow characteristics.

## Base materials

1.4462	X2 CrNiMoN 22-5-3	
1.4362	X2 CrNiN 23-4	
1.4462	X2 CrNiMoN 22-5-3 with	1.4583 X10 CrNiMoNb 18-12
1.4462	X2 CrNiMoN 22-5-3 with	P2356H / P265GH / S255H / P2956H / S35N / 16Mo3 UNS S31803; S32205

## Typical analysis in %

C	Si	Mn	Cr	Mo	Ni	N	Fe
0.015	0.35	1.5	22.8	3.0	9.0	0.14	balance

## Mechanical properties of the weld metal

Yield strength $R_{p0.2}$	Tensile strength $R_m$	Elongation A	Impact strength $K_{Ic}$
MPa	MPa	%	J [RT]
600	800	30	80

## Welding instructions

Welding area must be thoroughly cleaned to metallic bright and degreased. Preheating and post heat treatment are usually not necessary. The interpass temperature should not exceed 150 °C.

## Approvals

TÜV (No. 05550), GL

## Form of delivery and recommended welding parameters

Rod diameter x length [mm]	Current type	Shielding gas (EN ISO 14175)
1.6 x 1000	DC (-)	I 1
2.0 x 1000	DC (-)	I 1
2.4 x 1000	DC (-)	I 1
3.2 x 1000	DC (-)	I 1

## Classifications

TIG rod

EN ISO 14343-A	AWS A5.9	Material-No.
W 23 12 L (Si)	ER 309 L (Si)	1.4332

## Characteristics and field of use

UTP A 6824 LC ist used for joining and surfacing in chem. apparatus and vessel construction for working temperatures up to +300 °C. Weld cladding of non- and low-alloyed base materials. Dissimilar joints.

## Base materials

1.4306	X2 CrNi 19-11
1.4401	X5 CrNiMo 17-12-2
1.4404	X2 CrNiMo 17-13-2
1.4541	X6 CrNiTi 18-10
1.4550	X6 CrNiNb 18-10
1.4571	X6 CrNiMoTi 17-12-2
1.4580	X6 CrNiMoNb 17-12-2

Joining these materials with unalloyed and low-alloyed steels is possible.

## Typical analysis in %

C	Si	Mn	Cr	Ni	Fe
0.02	0.4	1.8	23.0	13.5	balance

## Mechanical properties of the weld metal

Yield strength $R_{p0.2}$	Tensile strength $R_m$	Elongation $A$	Impact strength $K_V$
MPa	MPa	%	J [RT]
400	590	30	140

## Welding instructions

Welding area must be thoroughly cleaned to metallic bright and degreased. Heat-resistant Cr-steels or cast steels have to be preheated according to the base metal. No preheating for similar austenitic steels.

## Approvals

TÜV (No. 05391)

## Form of delivery and recommended welding parameters

Rod diameter x length [mm]	Current type	Shielding gas (EN ISO 14175)
1.6 x 1000	DC (-)	I 1
2.0 x 1000	DC (-)	I 1
2.4 x 1000	DC (-)	I 1
3.2 x 1000	DC (-)	I 1

## TIG rods for repair of cracked material

### 3. Nickel alloys

Product name	EN ISO	AWS	Mat. - No.	Page
UTP A 80 M	18274	S Ni 4060 (NiCu30Mn3Ti)	A5.14 ER NiCu-7	2.4377 107
UTP A 80 Ni	18274	S Ni 2061 (NiTi3)	A5.14 ER Ni-1	2.4155 108
UTP A 068 HH	18274	S Ni 6082 (NiCr20Mn3Nb)	A5.14 ER NiCr-3	2.4806 109
UTP A 722	18274	S Ni 6022 (NiCr21Mo13Fe4W3)	A5.14 ER NiCrMo-10	110
UTP A 759	18274	S Ni 6059 (NiCr23Mo16)	A5.14 ER NiCrMo-13	2.4607 111
UTP A 776	18274	S Ni 6276 (NiCr15Mo16Fe6W4)	A5.14 ER NiCrMo-4	2.4886 112
UTP A 2133 Mn	14343	WZ 21 33 Mn Nb		~ 1.4850 113
UTP A 2535 Nb	14343-A	WZ 25 35 Zr		1.4853 114
UTP A 3545 Nb	18274	S Ni Z (NiCr- 36Fe15Nb0.8)		115
UTP A 4221	18274	S Ni 8065 (NiFe30Cr21Mo3)	A5.14 ER NiFeCr-1 (UNS N08065)	116
UTP A 6170 Co	18274	S Ni 6617 (NiCr22Co12Mo9)	A5.14 ER NiCrCoMo-1	2.4627 117
UTP A 6222 Mo	18274	S Ni 6625 (NiCr22Mo9Nb)	A5.14 ER NiCrMo-3	2.4831 118
UTP A 6225 AL	18274	S Ni 6025 (NiCr25Fe10AlY)	A5.14 ER NiCrFe-12	2.4649 119
UTP A 8036 S	Special alloy			120

#### Solution examples

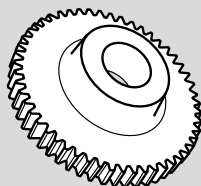

*Gear wheel*

UTP A 068 HH

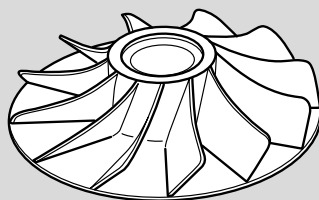

*Turbine*

UTP A 6170 Co mod.

## Classifications

TIG rod

EN ISO 18274	AWS A5.14	Material-No.
S Ni 4060 (NiCu30Mn3Ti)	ER NiCu-7	2.4377

## Characteristics and field of use

UTP A 80 M is suitable for joining and surfacing of nickel-copper alloys and of nickel-copper-clad steels. Particularly suited for the following materials: 2.4360 NiCu30Fe, 2.4375 NiCu30Al.

UTP A 80 M is also used for joining different materials, such as steel to copper and copper alloys, steel to nickel-copper alloys. These materials are employed in high-grade apparatus construction, primarily for the chemical and petrochemical industries. A special application field is the fabrication of seawater evaporation plants and marine equipment.

The weld metal has an excellent resistance to a large amount of corrosive medias, from pure water to nonoxidising mineral acids, alkali and salt solutions.

## Typical analysis in %

C	Si	Mn	Cu	Ni	Ti	Fe
< 0.02	0.3	3.2	29.0	balance	2.4	1.0

## Mechanical properties of the weld metal

Yield strength $R_{p0.2}$	Tensile strength $R_m$	Elongation $A$	Impact strength $K_V$
MPa	MPa	%	J [RT]
> 300	> 480	> 30	> 80

## Welding instructions

Clean the weld area thoroughly to avoid porosity. Opening groove angle about 70 °. Weld stringer beads.

## Approvals

TÜV (No. 00249), ABS, GL

## Form of delivery and recommended welding parameters

Rod diameter x length [mm]	Current type	Shielding gas (EN ISO 14175)
1.6 x 1000	DC (-)	I 1
2.0 x 1000	DC (-)	I 1
2.4 x 1000	DC (-)	I 1
3.2 x 1000	DC (-)	I 1

## UTP A 80 Ni

nickel alloys

## Classifications

TIG rod

EN ISO 18274	AWS A5.14	Material-No.
S Ni 2061 (NiTi3)	ER Ni-1	2.4155

## Characteristics and field of use

UTP A 80 Ni is suited for joining and surfacing on commercial pure nickel grades, including LC nickel, nickel alloys and nickel-clad steels.

Such materials are employed primarily in the construction of pressure vessels and apparatus in the chemical industry, in the food industry and for power generation, where good behaviour under corrosion and temperature is demanded.

The weld metal has an excellent resistance in a lot of corrosive medias, from acid to alkali solutions.

## Typical analysis in %

C	Si	Mn	Ni	Ti	Fe
< 0.02	< 0.3	0.3	balance	3.3	< 0.1

## Mechanical properties of the weld metal

<i>Yield strength</i> $R_{p0.2}$	<i>Tensile strength</i> $R_m$	<i>Elongation</i> $A$	<i>Impact strength</i> $K_v$
MPa	MPa	%	J [RT]
> 300	> 450	> 30	> 160

## Welding instructions

Clean the weld area thoroughly to avoid porosity. Groove angle about 70 °. To be welded by stringer bead technique.

## Approvals

TÜV (No. 00951), ABS

## Form of delivery and recommended welding parameters

<i>Rod diameter x length [mm]</i>	<i>Current type</i>	<i>Shielding gas (EN ISO 14175)</i>
1.6 x 1000	DC (-)	I 1
2.0 x 1000	DC (-)	I 1
2.4 x 1000	DC (-)	I 1
3.2 x 1000	DC (-)	I 1

## Classifications

TIG rod

EN ISO 18274	AWS A5.14	Material-No.
S Ni 6082 (NiCr20Mn3Nb)	ER NiCr-3	2.4806

## Characteristics and field of use

UTP A 068 HH is predominantly used for joining identical or similar high heat resistant Ni-base alloys, heat resistant austenites, and for joining heat resistant austenitic-ferritic materials such as

2.4816	NiCr15Fe	UNS N06600
2.4817	LC- NiCr15Fe	UNS N10665
1.4876	X10 NiCrAlTi 32 20	UNS N08800
1.6907	X3 CrNiN 18 10	

Also used for joinings of high C content 25 / 35 CrNi cast steel to 1.4859 or 1.4876 for petrochemical installations with service temperatures up to 900 °C. Furthermore, UTP A 068 HH can be used for repair welding of hardly weldable steels such as heat-treatable steels or tool steels. Additionally mixed joints of austenitic and ferritic materials with elevated service temperatures can be welded.

The welding deposit is hot cracking resistant and does not tend to embrittlement.

## Typical analysis in %

C	Si	Mn	Cr	Ni	Nb	Fe
< 0.02	< 0.2	3.0	20.0	balance	2.7	0.8

## Mechanical properties of the weld metal according to EN ISO 15792-1 (min. values at RT)

Yield strength $R_{p0.2}$	Tensile strength $R_m$	Elongation $A$	Impact strength $K_V$	
MPa	MPa	%	J [RT]	- 196 °C
> 380	> 640	> 35	160	80

## Welding instructions

Clean weld area thoroughly. Keep heat input as low as possible and interpass temperature at approx. 150 °C.

## Approvals

TÜV (No. 00883), KTA, ABS, DNV GL

## Form of delivery and recommended welding parameters

Rod diameter x length [mm]	Current type	Shielding gas (EN ISO 14175)	
1.6 x 1000	DC (-)	I 1	R 1
2.0 x 1000	DC (-)	I 1	R 1
2.4 x 1000	DC (-)	I 1	R 1
3.2 x 1000	DC (-)	I 1	R 1

## UTP A 722

nickel alloys

## Classifications

TIG rod

EN ISO 18274	AWS A 5.14	Material-No.
S Ni 6022 (NiCr21Mo13Fe4W3)	ER NiCrMo-10	2.4635

## Characteristics and field of use

UTP A 722 is suitable for joining materials of the same and similar nature, e.g. material-no. 2.4602 (NiCr21Mo14W / UNS N06022) and special stainless steels. Furthermore it can be used for dissimilar joints of these alloys with low-alloyed materials and cladding on low-alloyed steels.

UTP A 722 is commonly used in the production of components and plants for chemical processes involving highly corrosive media.

Good corrosion-resistance against acetic acid and its anhydride, hot contaminated sulphuric and phosphoric acids and other contaminated oxidizing mineral acids.

Intermetallic precipitation is widely prevented.

## Typical analysis in %

C	Si	Mn	P	S	Cr	Mo
< 0.01	< 0.1	< 0.5	< 0.015	< 0.01	21.0	13.0
Ni	V	W	Cu	Co	Fe	
balance	< 0.2	3.0	< 0.2	< 2.5	3.0	

## Mechanical properties of the weld metal

<i>Yield strength</i> $R_{p0.2}$	<i>Tensile strength</i> $R_m$	<i>Elongation</i> $A$	<i>Impact strength</i> $K_v$
MPa	MPa	%	J [RT]
> 400	> 700	> 30	> 70

## Welding instructions

The weld area has to be free from impurities such as oil, paint, markings or metal dust. Minimize heat input. The interpass temperature should not exceed 150°C. Linear energy input < 12 kJ / cm.

## Form of delivery and recommended welding parameters

<i>Rod diameter x length</i> [mm]	<i>Current type</i>	<i>Shielding gas</i> (EN ISO 14175)
2.4 x 1000	DC (-)	R 1



## Classifications

TIG rod

EN ISO 18274	AWS A5.14	Material-No.
S Ni 6059 (NiCr23Mo16)	ER NiCrMo-13	2.4607

## Characteristics and field of use

UTP A 759 is suitable for welding components in plants for chemical processes with highly corrosive media.

For joining materials of the same or similar natures, e.g.

2.4602	NiCr21Mo14W	UNS N06022
2.4605	NiCr23Mo16Al	UNS N06059
2.4610	NiMo16Cr16Ti	UNS N06455
2.4819	NiMo16Cr15W	UNS N10276

and these materials with low alloyed steels such as for surfacing on low alloyed steels.

Good corrosion resistance against acetic acid and acetic hydride, hot contaminated sulphuric and phosphoric acids and other contaminated oxidising mineral acids. Intermetallic precipitation will be largely avoided.

## Typical analysis in %

C	Si	Cr	Mo	Ni	Fe
< 0.01	0.1	22.5	15.5	balance	< 1.0

## Mechanical properties of the weld metal

Yield strength $R_{p0.2}$	Tensile strength $R_m$	Elongation $A$	Impact strength $K_V$
MPa	MPa	%	J [RT]
> 450	> 720	> 35	> 100

## Welding instructions

The welding area has to be free from impurities (oil, paint, grease and dust). Minimize heat input. The interpass temperature should not exceed 150 °C. Heat input < 12 kJ / cm

## Approvals

TÜV (No. 06068), GL

## Form of delivery and recommended welding parameters

Rod diameter x length [mm]	Current type	Shielding gas (EN ISO 14175)	
1.6 x 1000	DC (-)	I 1	R 1
2.0 x 1000	DC (-)	I 1	R 1
2.4 x 1000	DC (-)	I 1	R 1
3.2 x 1000*	DC (-)	I 1	R 1

\*available on request

# UTP A 776

## Classifications

TIG rod

EN ISO 18274

AWS A5.14

Material-No.

S Ni 6276 (NiCr15Mo16Fe6W4)

ER NiCrMo-4

2.4886

## Characteristics and field of use

UTP A 776 is suitable for joint welding of matching base materials, as 2.4819 NiMo16Cr15W UNS N10276 and surface weldings on low-alloyed steels.

UTP A 776 is employed primarily for welding components in plants for chemical processes with highly corrosive media, but also for surfacing press tools, punches, etc. which operate at high temperature.

Excellent resistance against sulphuric acids at high chloride concentrations.

## Typical analysis in %

C	Si	Cr	Mo	Ni	V	W	Fe
< 0.01	0.07	16.0	16.0	balance	0.2	3.5	6.0

## Mechanical properties of the weld metal

Yield strength $R_{p0.2}$	Tensile strength $R_m$	Elongation $A$	Impact strength $K_v$
MPa	MPa	%	J [RT]
> 450	> 750	> 30	> 90

## Welding instructions

To avoid intermetallic precipitations, the rod should be welded with lowest possible heat input and interpass temperature.

## Approvals

TÜV (No. 05587)

## Form of delivery and recommended welding parameters

Rod diameter x length [mm]	Current type	Shielding gas (EN ISO 14175)
1.6 x 1000	DC (-)	R 1
2.0 x 1000	DC (-)	R 1
2.4 x 1000	DC (-)	R 1
3.2 x 1000	DC (-)	R 1

## Classifications

TIG rod

EN ISO 14343

Material-No.

WZ 21 33 Mn Nb

~ 1.4850

## Characteristics and field of use

UTP A 2133 Mn is suitable for joining and surfacing heat resistant base materials of identical and of similar nature, such as

1.4859	G X 10 NiCrNb 32 20	
1.4876	X 10 NiCrAlTi 32 21	UNS N08800
1.4958	X 5 NiCrAlTi 31 20	UNS N08810
1.4959	X 8 NiCrAlTi 31 21	UNS N08811

A typical application is the root welding of centrifugally cast pipes in the petrochemical industry for operation temperatures up to 1050 °C in dependence with the atmosphere.

Scale resistant up to 1050 °C. Good resistance to carburising atmosphere.

## Typical analysis in %

C	Si	Mn	Cr	Ni	Nb	Fe
0.12	0.3	4.5	21.0	33.0	1.2	balance

## Mechanical properties of the weld metal

Yield strength $R_{p0.2}$	Tensile strength $R_m$	Elongation $A$	Impact strength $K_V$
MPa	MPa	%	J [RT]
400	600	20	70

## Welding instructions

Clean the weld area thoroughly. Low heat input. Max. interpass temperature 150 °C

## Approvals

TÜV (No. 10451)

## Form of delivery and recommended welding parameters

Rod diameter x length [mm]	Current type	Shielding gas (EN ISO 14175)
2.0 x 1000	DC (-)	I 1
2.4 x 1000	DC (-)	I 1
3.2 x 1000	DC (-)	I 1

**Classifications**

TIG rod

EN ISO 14343-A

Material-No.

WZ 25 35 Zr

1.4853

**Characteristics and field of use**

UTP A 2535 Nb is suitable for joinings and building up on identical and similar high heat resistant CrNi cast steel (centrifugal- and mould cast parts), such as

- 1.4848 G – X 40 CrNiSi 25 20
- 1.4852 G – X 40 NiCrSiNb 35 25
- 1.4857 G – X 40 NiCrSi 35 25

The weld deposit is applicable in a low sulphur, carbon enriching atmosphere up to 1150 °C, such as reformer ovens in petrochemical installations.

**Typical analysis in %**

C	Si	Mn	Cr	Ni	Nb	Ti	Zr	Fe
0.4	1.0	1.7	25.5	35.5	1.2	+	+	balance

**Mechanical properties of the weld metal**

Yield strength $R_{p0.2}$	Tensile strength $R_m$	Elongation $A$
MPa	MPa	%
> 480	> 680	> 8

**Welding instructions**

Clean welding area carefully. No pre-heating or post weld heat treatment. Keep heat input as low as possible and interpass temperature at max. 150 °C.

**Form of delivery and recommended welding parameters**

Rod diameter x length [mm]	Current type	Shielding gas (EN ISO 14175)
2.0 x 1000	DC (-)	I 1
2.4 x 1000	DC (-)	I 1
3.2 x 1000	DC (-)	I 1

# UTP A 3545 Nb

nickel alloys

## Classifications

TIG rod

EN ISO 18274

S Ni Z (NiCr36Fe15Nb0.8)

## Characteristics and field of use

UTP A 3545 Nb is suitable for joining and surfacing on identical and similar high-heat-resistant cast alloys (centrifugal- and mould cast parts), such as GX-45NiCrNbSiTi45 35. The main application field is tubes and cast parts of reformer and pyrolysis ovens.

The weld deposit is applicable in low-sulphur, carbon-enriching atmosphere up to 1,175 °C. It yields excellent creep strength and a good resistance against carburization and oxidation.

## Typical analysis in %

C	Si	Mn	Cr	Ni	Nb	Ti	Zr	Fe
0.45	1.5	0.8	35.0	45.0	0.8	0.1	0.05	balance

## Mechanical properties of the weld metal

<i>Yield strength <math>R_{p0.2}</math></i>	<i>Tensile strength <math>R_m</math></i>
<i>MPa</i>	<i>MPa</i>
450	650

## Welding instructions

Clean weld area thoroughly. No pre-heating or post weld heat treatment required. Keep heat input as low as possible and interpass temperature of max. 150 °C.

## Form of delivery and recommended welding parameters

<i>Rod diameter x length [mm]</i>	<i>Current type</i>	<i>Shielding gas (EN ISO 14175)</i>
2.0 x 1000	DC (-)	I 1
2.4 x 1000	DC (-)	I 1
3.2 x 1000	DC (-)	I 1

## UTP A 4221

### Classifications

TIG rod

EN ISO 18274

AWS A5.14

S Ni 8065 (NiFe30Cr21Mo3)

ER NiFeCr-1 (UNS N08065)

### Characteristics and field of use

UTP A 4221 is suitable for joining and surfacing of alloys of similar nature, furthermore for welding of CrNi-MoCu-alloyed austenitic steels used for high quality tank and apparatus construction in the chemical industry, corrosion resistance in media of sulphuric and phosphoric acid.

UTP A 4221 is specially designed for welding alloy 825 (2.4858, UNS N08825).

Fully austenitic weld metal with high resistance against stress corrosion cracking and pitting in media containing chloride ions. Good corrosion resistance against reducing acids due to the combination of Ni, Mo and Cu. Sufficient resistance against oxidizing acids. The weld metal is corrosion resistant in sea water.

### Typical analysis in %

C	Si	Mn	Cr	Ni	Mo	Cu	Fe
0.01	0.25	0.8	20.5	41.0	3.1	1.8	balance

### Mechanical properties of the weld metal

Yield strength $R_{p0.2}$	Tensile strength $R_m$	Elongation $A$	Impact strength $K_v$
MPa	MPa	%	J [RT]
360	> 550	> 30	> 100

### Welding instructions

The welding area has to be free from impurities (oil, paint, markings). Minimize heat input. The interpass temperature should not exceed 120 °C.

### Form of delivery and recommended welding parameters

Rod diameter x length [mm]	Current type	Shielding gas (EN ISO 14175)
2.4 x 1000	DC (-)	I 1

# UTP A 6170 Co

nickel alloys

## Classifications

NiCrCoMo rods

EN ISO 18274	AWS A5.14	Material-No.
S Ni 6617 (NiCr22Co12Mo9)	ER NiCrCoMo-1	2.4627

## Characteristics and field of use

UTP A 6170 Co is particularly used for joining heat-resistant and creep-resistant nickel-base alloys of identical and similar nature, high-temperature austenitic and cast alloys, such as:

1.4958	X5NiCrAlTi 31 20	UNS N08810
1.4959	X8NiCrAlTi 32 21	UNS N08811
2.4663	NiCr23Co12Mo	UNS N06617

The weld metal is resistant to hot-cracking. It is used for operating temperatures up to 1100 °C. Scale-resistant at temperatures up to 1100 °C in oxidizing resp. carburizing atmospheres, e. g. gas turbines, ethylene production plants.

## Typical analysis in %

C	Si	Cr	Mo	Ni	Co	Ti	Al	Fe
0.06	< 0.3	22.0	8.5	balance	11.5	0.4	1.0	1.0

## Mechanical properties of the weld metal

<i>Yield strength <math>R_{p0.2}</math></i>	<i>Tensile strength <math>R_m</math></i>	<i>Elongation <math>A</math></i>	<i>Impact strength <math>K_V</math></i>
<i>MPa</i>	<i>MPa</i>	<i>%</i>	<i>J [RT]</i>
> 450	> 750	> 30	> 120

## Welding instructions

Clean welding area carefully. Keep heat input as low as possible and interpass temperature at max. 150 °C.

## Approvals

TÜV (No. 05451)

## Form of delivery and recommended welding parameters

<i>Rod diameter x length [mm]</i>	<i>Current type</i>	<i>Shielding gas (EN ISO 14175)</i>	
1.6 x 1000	DC (-)	I 1	R 1
2.0 x 1000	DC (-)	I 1	R 1
2.4 x 1000	DC (-)	I 1	R 1
3.2 x 1000	DC (-)	I 1	R 1

## UTP A 6222 Mo

nickel alloys

## Classifications

TIG rod

EN ISO 18274	AWS A5.14	Material-No.
S Ni 6625 (NiCr22Mo9Nb)	ER NiCrMo-3	2.4831

## Characteristics and field of use

UTP A 6222 Mo has a high nickel content and is suitable for welding high-strength and high-corrosion resistant nickel-base alloys, e.g.

1.4529	X1 NiCrMoCuN25206	UNS N08926
1.4539	X1 NiCrMoCuN25205	UNS N08904
2.4858	NiCr21Mo	UNS N08825
2.4856	NiCr22Mo9Nb	UNS N06625

It can be used for joining ferritic steel to austenitic steel as well as for surfacing on steel. It is also possible to weld 9 % nickel steels using this wire due to its high yield strength. Its wide range of uses is of particular significance in aviation, in chemical industry and in applications involving seawater.

The special features of the weld metal of UTP A 6222 Mo include a good creep rupture strength, corrosion resistance, resistance to stress and hot cracking. It is highly resistant and tough even at working temperatures up to 1100 °C. It has an extremely good fatigue resistance due to the alloying elements Mo and Nb in the NiCr-matrix. The weld metal is highly resistant to oxidation and is almost immune to stress corrosion cracking. It resists intergranular penetration without having been heat-treated.

## Typical analysis in %

C	Si	Cr	Mo	Ni	Nb	Fe
< 0.02	< 0.2	22.0	9.0	balance	3.5	1.0

## Mechanical properties of the weld metal

Yield strength $R_{p0.2}$	Tensile strength $R_m$	Elongation $A$	Impact strength $K_v$	
MPa	MPa	%	J [RT]	J [-196°C]
> 460	> 740	> 30	> 100	> 85

## Welding instructions

The welding area has to be free from impurities (oil, paint, grease). Minimize heat input. The interpass temperature should not exceed 150 °C. Heat input < 12 kJ / cm

## Approvals

TÜV (No. 03461), DNV GL, ABS

## Form of delivery and recommended welding parameters

Rod diameter x length [mm]	Current type	Shielding gas (EN ISO 14175)	
1.6 x 1000	DC (-)	I 1	R 1
2.0 x 1000	DC (-)	I 1	R 1
2.4 x 1000	DC (-)	I 1	R 1
3.2 x 1000*	DC (-)	I 1	R 1

\*available on request



## Classifications

TIG rod

EN ISO 18274	AWS A5.14	Material-No.
S Ni 6025 (NiCr25Fe10AlY)	ER NiCrFe-12	2.4649

## Characteristics and field of use

UTP A 6225 Al is suitable for welding of identical and similar alloys, such as NiCr25FeAlY, Material-No. 2.4633. These alloys are applicable for working temperatures up to 1200 °C, particularly for thermal treatment ovens.

High oxidation resistance at high temperatures (also in cyclic conditions), very good corrosion resistance in carburized medias, excellent high temperature resistance.

## Typical analysis in %

C	Si	Mn	Cr	Ni	Ti	Zr	Al	Fe	Y
0.2	0.5	0.1	25.0	balance	0.15	0.05	2.0	10.0	0.08

## Mechanical properties of the weld metal

Yield strength $R_{p0.2}$	Tensile strength $R_m$	Elongation $A$	Impact strength $K_V$
MPa	MPa	%	J [RT]
500	720	25	50

## Welding instructions

Clean the weld area thoroughly (free of oil, scale, markings). UTP A 6225 Al is welded in TIG- and Plasmaprocess (with external cold wire feeding). Use stringer bead technique. Keep heat input as low as possible (TIG max. 6.5 kJ / cm, TIG-Plasma max. 11 kJ / cm) and interpass temperature at max. 150 °C. UTP A 6225 Al should only be welded by using the below recommended gas.

## Approvals

TÜV (No. 10145)

## Form of delivery and recommended welding parameters

Rod diameter x length [mm]	Current type	Shielding gas (EN ISO 14175)
1.6 x 1000	DC ( - )	N2-ArN-2
2.0 x 1000	DC ( - )	N2-ArN-2
2.4 x 1000	DC ( - )	N2-ArN-2

**Classifications**

TIG rod

Special alloy

**Characteristics and field of use**

UTP A 8036 S is an alloy of the same composition as the base material and used for welding cast alloys with a nickel content of 34 – 40 % (INVAR qualities). The special operational area is the structural welding of housings made of plate and cast pieces with a nickel content of 36 %. Application field: air plane construction.

The weld metal contains high mechanical properties and a very low expansion coefficient.

**Typical analysis in %**

C	Si	Mn	P	S	Ni	Fe
0.015-0.025	0.1	0.3	< 0.01	< 0.01	34.0-38.0	balance

**Mechanical properties of the weld metal**

<i>Yield strength</i> $R_{p0.2}$	<i>Tensile strength</i> $R_m$	<i>Elongation A</i>	<i>Impact strength</i> $K_V$	<i>Hardness</i>
MPa	MPa	%	J	HB
> 280	> 350	> 25	> 80	appr. 150

**Welding instructions**

Thorough cleaning of welding area is essential. Welding parameters need to be adjusted to each individual application. Pay attention to a low heat input. The weld should be performed by applying a pulsed technique.

**Form of delivery and recommended welding parameters**

<i>Rod diameter x length [mm]</i>	<i>Current type</i>	<i>Shielding gas (EN ISO 14175)</i>
2.0 x 1000*	DC ( - )	I 1
2.4 x 1000*	DC ( - )	I 1

\*available on request

## TIG rods for repair of cracked material

### 4. Cast iron

Product name	EN ISO		AWS		Page
UTP A 8051 Ti	1071	S C NiFe-2			122

#### Solution example

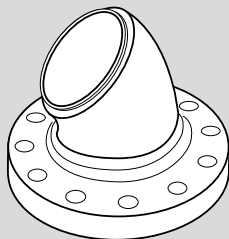

#### Flange

UTP A 8051 Ti

**Classifications**

TIG rod

EN ISO 1071

S C NiFe-2

**Characteristics and field of use**

UTP A 8051 Ti is particularly suited for welding of ferritic and austenitic nodular cast iron as well as for joining it with unalloyed and high-alloyed steels, copper and nickel alloys. Build-up layers on grey cast iron qualities are also possible. Special applications are construction welding of ductile centrifugal casting tubes, such as joggles and flange joints, fittings, pumps.

The deposit is tough, crack resistant and easily machinable with cutting tools.

**Typical analysis of rod and wire in %**

C	Mn	Ni	Ti	Fe
0.1	3.5	55.0	0.5	balance

**Mechanical properties of the weld metal**

<i>Yield strength <math>R_e</math></i>	<i>Tensile strength <math>R_m</math></i>	<i>Elongation <math>A_5</math></i>	<i>Hardness</i>
<i>MPa</i>	<i>MPa</i>	<i>%</i>	<i>HB</i>
> 300	> 500	> 25	approx. 200

**Welding instructions**

Machine welding area to metallic bright. Preheat massive cast iron pieces to 150 – 250 °C. Weld preferably with TIG-pulsed arc, in order to reduce the dilution with the base metal.

**Form of delivery and recommended welding parameters**

<i>Rod diameter x length [mm]</i>	<i>Current type</i>	<i>Shielding gas (EN ISO 14175)</i>
1.6 x 1000*	DC (-)	I 1
2.4 x 1000*	DC (-)	I 1

\*available on request

## TIG rods for repair of cracked material

### 5. Copper alloys

Product name	EN ISO	AWS	Mat.-No.	Page
UTP A 34	24373 S Cu 6100 (CuAl7)	A5.7 ER CuAl-A 1	2.0921	124
UTP A 34 N	24373 S Cu 6338 (CuMn13Al8Fe3Ni2)	A5.7 ER CuMnNiAl	2.1367	125
UTP A 38	24373 S Cu 1897 (CuAg1)	A5.7 ER Cu	2.1211	126
UTP A 381	24373 S Cu 1898 (CuSn1)	A5.7 ER Cu	2.1006	127
UTP A 384	24373 S Cu 6560 (CuSi3Mn1)	A5.7 ER CuSi-A	2.1461	128
UTP A 387	24373 S Cu 7158 (CuNi30Mn1FeTi)	A5.7 ER CuNi	2.0837	129
UTP A 3422	24373 S Cu 6327 (CuAl8Ni2Fe2Mn2)		2.0922	130
UTP A 3422 MR	DIN 1733 SG-CuAl8Ni2Fe2Mn2		2.0922	131
UTP A 3444	24373 S Cu 6328 (CuAl9Ni5Fe3Mn2)	A5.7 ER CuNiAl	2.0923	132

#### Solution examples

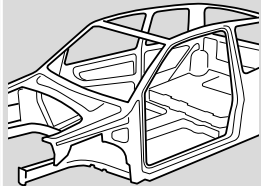
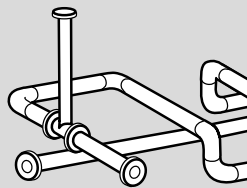
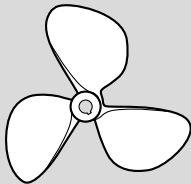

*Ship propeller*

*Piping*

*Body work*

UTP A 34 N

UTP A 38

UTP A 384

**UTP A 34**

copper alloys

**Classifications**

TIG rod

EN ISO 24373	AWS A5.7	Material-No.
S Cu 6100 (CuAl7)	ER CuAl-A 1	2.0921

**Characteristics and field of use**

UTP A 34 is used for copper aluminium alloys (aluminium bronzes) with 5 – 9 % Al, copper-zinc alloys (brass and special brass). Weld cladding on cast iron materials and steel.

The weld deposit of UTP A 34 is resistant to corrosion and seawater and has good gliding properties metal-metal. UTP A 34 is easy weldable and obtains a clean weld surface.

**Typical analysis of rod and wire in %**

Mn	Ni	Cu	Al	Fe
< 0.5	< 0.5	balance	8.0	< 0.5

**Mechanical properties of the weld metal**

Yield strength $R_{p0.2}$	Tensile strength $R_m$	Elongation $A_5$	Hardness $HB$	El. conductivity $\frac{S \cdot m}{mm^2}$	Melting range $^{\circ}C$
MPa	MPa	%			
180	400	40	120	8	1030 – 1040

**Welding instructions**

The weld seam area has to be machined to a metallic bright by grinding, sand blasting or pickling in order to avoid crack formation or the development of pores. To avoid oxyd formation, UTP Flux 34 Sp needs to be deposited onto the base rods prior to the welding process.

**Form of delivery and recommended welding parameters**

Rod diameter x length [mm]	Current type	Shielding gas (EN ISO 14175)
1.6 x 1000	DC (-)	I 1
2.0 x 1000	DC (-)	I 1
2.4 x 1000	DC (-)	I 1
3.2 x 1000	DC (-)	I 1

## Classifications

TIG rod

EN ISO 24373	AWS A5.7	Material-No.
S Cu 6338 (CuMn13Al8Fe3Ni2)	ER CuMnNiAl	2.1367

## Characteristics and field of use

UTP A 34 N is applied in TIG joining and surfacing on complex aluminium bronzes mainly on such materials with a high Mn content as well as on steel and cast steel by using a nodular iron rod. Because of the excellent resistance to seawater and general corrosion resistance, the alloy is excellently suited in the shipbuilding industry (propellers, pumps and armatures) and in the chemical industry (valves, slides, pumps) and is mainly for applications subjected to chemical attacks combined with erosion. Because of the good friction coefficient it is suited for surfacing on waves, gliding surfaces, bearing and matrix of all sorts.

UTP A 34 N is very good weldable in the TIG process. The weld deposit has excellent mechanical properties and is tough and crack resistant. Very good chip removal machining, corrosion resistant and non magnetic.

## Typical analysis of rod and wire in %

Mn	Ni	Cu	Al	Fe
13.0	2.5	balance	7.5	2.5

## Mechanical properties of the weld metal

Yield strength $R_{p0.2}$	Tensile strength $R_m$	Elongation $A_5$	Hardness $HB$	El. conductivity $\frac{S \cdot m}{mm^2}$	Melting range $^{\circ}C$
MPa	MPa	%	HB		$^{\circ}C$
400	650	15	220	3 – 5	945 – 985

## Welding instructions

Clean weld area thoroughly (metallic bright). Preheating temperature of large weldments to approx. 150 °C. Heat-input should be kept low and the interpass temperature should not exceed 150 °C.

## Form of delivery and recommended welding parameters

Rod diameter x length [mm]	Current type	Shielding gas (EN ISO 14175)
1.6 x 1000	DC (–)	I 1
2.0 x 1000	DC (–)	I 1
2.4 x 1000	DC (–)	I 1
3.2 x 1000	DC (–)	I 1

## Classifications

TIG rod

EN ISO 24373	AWS A5.7	Material-No.
S Cu 1897 (CuAg1)	ER Cu	2.1211

## Characteristics and field of use

UTP A 38 is used for oxygen free copper types according to DIN 1787 OF-Cu, SE-Cu, SW-Cu, SF-Cu. The main applications are in the electrical industry e.g. for conductor rails or other applications where high electricity is required.

Viscous weld puddle, fine grained structure, high electrical conductivity.

## Typical analysis in %

Mn	Ni	Cu	Ag
< 0.2	< 0.3	balance	1.0

## Mechanical properties of the weld metal

Yield strength $R_{p0.2}$	Tensile strength $R_m$	Elongation $A_5$	Hardness $HB$	El. conductivity $\frac{S \cdot m}{mm^2}$	Melting range $^{\circ}C$
MPa	MPa	%			
80	200	20	60	30 – 45	1070 – 1080

## Welding instructions

Clean welding area thoroughly. For wall thickness of >3 mm a preheating is necessary (max 600 °C).

## Form of delivery and recommended welding parameters

Rod diameter x length [mm]	Current type	Shielding gas (EN ISO 14175)
1.6 x 1000	DC (–)	I 1
2.0 x 1000	DC (–)	I 1
2.4 x 1000	DC (–)	I 1
3.2 x 1000	DC (–)	I 1



## Classifications

TIG rod

EN ISO 24373	AWS A5.7	Material-No.
S Cu 1898 (CuSn1)	ER Cu	2.1006

## Characteristics and field of use

UTP A 381 is used for oxygen free copper types according to DIN 1787 OF-Cu, SE-Cu, SW-Cu, SF-Cu. The main applicational fields are in the apparatus- and pipeline construction.

Fluid weld pool.

## Typical analysis of rod and wire in %

Si	Mn	Ni	Cu	Sn
0.3	0.25	< 0.3	balance	0.8

## Mechanical properties of the weld metal

Yield strength $R_{p0.2}$ MPa	Tensile strength $R_m$ MPa	Elongation $A_5$ %	Hardness HB	El. conductivity $\frac{S \cdot m}{mm^2}$	Melting range °C
50	200	30	approx. 60	15 – 20	1020 – 1050

## Welding instructions

Clean weld area thoroughly. For each application field the parameters must be optimized. In a wall thickness > 3 mm, preheating to maximal 600 °C is necessary.

## Form of delivery and recommended welding parameters

Rod diameter x length [mm]	Current type	Shielding gas (EN ISO 14175)
1.6 x 1000	DC (–)	I 1
2.0 x 1000	DC (–)	I 1
2.4 x 1000	DC (–)	I 1
3.2 x 1000	DC (–)	I 1

**Classifications**

TIG rod

EN ISO 24373	AWS A5.7	Material-No.
S Cu 6560 (CuSi3Mn1)	ER CuSi-A	2.1461

**Characteristics and field of use**

UTP A 384 is especially suited for joints of coated steel plates according to the TIG welding for repair welding of motor vehicle bodies and plate constructions of all sorts. The alloy is also especially suited for hot galvanized and hot dip galvanized plates. Same joints on copper-silicon and copper-manganese alloys according to DIN 1766, as for example CuSi2Mn, CuSi3Mn, CuMn5, brass and red brass (tombac).

The low hardness of UTP A 384 allows a relatively easy machining of the visible weld seam in comparison to the iron base weld metal.

**Typical analysis of rod and wire in %**

Si	Mn	Cu	Sn	Fe
3.0	1.0	balance	< 0.2	< 0.3

**Mechanical properties of the weld metal**

Yield strength $R_{p0.2}$ MPa	Tensile strength $R_m$ MPa	Elongation $A_5$ %	Hardness HB	El. conductivity $\frac{S \cdot m}{mm^2}$	Melting range °C
120	350	40	80	3 – 4	965 – 1035

**Welding instructions**

Clean weld area thoroughly. Welding parameters have to be optimised for each usage. Pay attention to a low heat input. (short arc / TIG pulsed arc)

**Form of delivery and recommended welding parameters**

Rod diameter x length [mm]	Current type	Shielding gas (EN ISO 14175)
1.6 x 1000	DC (-)	I 1
2.0 x 1000	DC (-)	I 1
2.4 x 1000	DC (-)	I 1
3.2 x 1000	DC (-)	I 1

## Classifications

TIG rod

EN ISO 24373	AWS A5.7	Material-No.
S Cu 7158 (CuNi30Mn1FeTi)	ER CuNi	2.0837

## Characteristics and field of use

UTP A 387 is used for copper nickel alloys with up to 30 % nickel according to DIN 17664, such as CuNi20Fe (2.0878), CuNi30Fe (2.0882). Chemical industry, seawater desalination plants, ship building, offshore technique.

The weld metal of UTP A 387 is resistant to seawater and cavitation.

## Typical analysis in %

C	Mn	Ni	Cu	Ti	Fe
< 0.05	0.8	30.0	balance	< 0.5	0.6

## Mechanical properties of the weld metal

Yield strength $R_{p0.2}$	Tensile strength $R_m$	Elongation $A_5$	Hardness $HB$	El. conductivity $\frac{S \cdot m}{mm^2}$	Melting range $^{\circ}C$
> 200	> 360	> 30	120	3	1180 – 1240

## Welding instructions

V-butt weld with 70 ° included angle and root gap of 2 mm. Remove oxide skin to approx. 10 mm to the joint groove also on the backside of the weld.

## Approvals

TÜV (No. 01625), GL

## Form of delivery and recommended welding parameters

Rod diameter x length [mm]	Current type	Shielding gas (EN ISO 14175)
1.2 x 1000*	DC (-)	I 1
1.6 x 1000	DC (-)	I 1
2.0 x 1000	DC (-)	I 1
2.4 x 1000	DC (-)	I 1
3.2 x 1000	DC (-)	I 1

\*available on request

## Classifications

TIG rod

EN ISO 24373

Material-No.

S Cu 6327 (CuAl8Ni2Fe2Mn2)

2.0922

## Characteristics and field of use

UTP A 3422 is used for copper-aluminium alloys with Ni and Fe addition. Weld cladding on cast iron materials and steel. Mixed joints of aluminium bronze steel. It is resistant to seawater, and cavitation resistant.

The weld metal of UTP A 3422 is resistant to seawater and cavitation. Good suitability for simultaneous stress strain caused by seawater, cavitation and erosion.

## Typical analysis of rod and wire in %

Mn	Ni	Cu	Al	Fe
1.8	2.5	balance	8.5	1.5

## Mechanical properties of the weld metal

Yield strength $R_{p0.2}$	Tensile strength $R_m$	Elongation $A_5$	Hardness $HB$	El. conductivity $\frac{S \cdot m}{mm^2}$	Melting range $^{\circ}C$
300	650	25	160	5	1030 – 1050

## Welding instructions

The weld seam area has to be machined to a metallic bright by grinding, sand blasting or pickling in order to avoid crack formation or the development of pores. To avoid oxyd formation, UTP Flux 34 Sp needs to be deposited onto the base rods prior to the welding process.

## Approvals

GL

## Form of delivery and recommended welding parameters

Rod diameter x length [mm]	Current type	Shielding gas (EN ISO 14175)
2.0 x 1000	DC (-)	I 1
2.4 x 1000*	DC (-)	I 1
3.2 x 1000	DC (-)	I 1

\*available on request

## Classifications

flux coated TIG rod

DIN 1733

Material-No.

SG-CuAl8Ni2Fe2Mn2

2.0922

## Characteristics and field of use

UTP A 3422 MR TIG rods are especially designed for cladding applications on cast parts made of multicomponent aluminium bronze. The complex alloy has high resistance against erosion and cavitation pitting.

Because of the good corrosion resistance against seawater, the most common applications are in shipbuilding industry (propeller, pumps, and armatures) and seawater desalination plants.

The welding rods are provided with grooves, which are then filled with a suitable flux, so that an additional flux is not necessary and the optimum amount of flux is ensured for the processing.

## Typical analysis of rod and wire in %

Mn	Ni	Fe	Al	Cu
1.5	2.0	2.0	8.0	balance

## Mechanical properties of the weld metal

Yield strength $R_{p0.2}$	Tensile strength $R_m$	Elongation $A$	Hardness	Melting range
MPa	MPa	%	HB	°C
300	550	25	approx. 160	1030 – 1040

## Welding instructions

Prior to welding grind and clean the welding area. The surface should be free from any dust, oil or grease. Set the welding parameters as low as applicable in order to keep heat input low.

## Approvals

GL

## Form of delivery and recommended welding parameters

Rod diameter x length [mm]	Current type	Shielding gas (EN ISO 14175)
3.0 x 1000	DC ( - )	I 1

## Classifications

TIG rod

EN ISO 24373

AWS A5.7

Material-No.

S Cu 6328 (CuAl9Ni5Fe3Mn2)

ER CuNiAl

2.0923

## Characteristics and field of use

UTP A 3444 is a copper aluminium multi bronzes with a high Ni and Fe addition. Weld cladding on cast iron materials and steel. Mixed joints with aluminium bronze steel. It is resistant to seawater and cavitation resistant.

The weld metal of UTP A 3444 is resistant to seawater and cavitation. Good suitability for simultaneous stress strain caused by seawater, cavitation and erosion.

## Typical analysis of rod and wire in %

Mn	Ni	Cu	Al	Fe
1.0	4.5	balance	9.0	3.5

## Mechanical properties of the weld metal

Yield strength $R_{p0.2}$	Tensile strength $R_m$	Elongation $A_5$	Hardness $HB$	El. conductivity $\frac{S \cdot m}{mm^2}$	Melting range $^{\circ}C$
400	700	15	200	4	1015 – 1045

## Welding instructions

The weld seam area has to be machined to a metallic bright by grinding, sand blasting or pickling in order to avoid crack formation or the development of pores. To avoid oxyd formation, UTP Flux 34 Sp needs to be deposited onto the base rods prior to the welding process.

## Approvals

TÜV (No. 01896), GL

## Form of delivery and recommended welding parameters

Rod diameter x length [mm]	Current type	Shielding gas (EN ISO 14175)
2.0 x 1000	DC (-)	I 1
2.4 x 1000	DC (-)	I 1
3.2 x 1000	DC (-)	I 1

## TIG rods for repair of cracked material

### 6. Tool steels

Product name	EN ISO	AWS	Mat.-No.	Page
UTP A 73 G2	14700 S Fe8		Special alloy	134
UTP A 73 G3	14700 S Z Fe3		Special alloy	135
UTP A 73 G4	14700 S Z Fe3			136
UTP A 673	14700 S Fe8		1.2606	137
UTP A 696	14700 S Z Fe4		1.3348	138
UTP A 702	14700 S Z Fe5		1.6356	139
UTP A DUR 600	14700 S Fe 8		1.4718	140

#### Solution examples

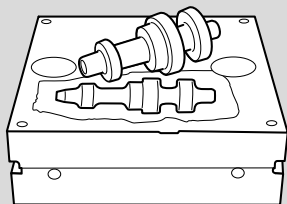

Forging die

UTP A 73-G-Reihe

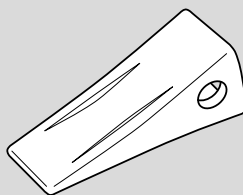

Shovel teeth

UTP A DUR 600

**Classifications**

TIG rod

EN 14700

DIN 8555

Material-No.

S Fe8

W3-GZ-55-ST

Special alloy

**Characteristics and field of use**

UTP A 73 G 2 is used for highly wear resistant build-ups on machine parts and tools, subject to heavy abrasion and compression combined with moderate impact at elevated temperatures, such as forging tools, roll mandrils, hot trimming knives, mangle and axial rolls as well as for the production of high-quality working surfaces by cladding non- or low-alloy base material.

Machinable by grinding or with tungsten carbide tools.

Hardness of the pure weld deposit :

untreated	53 – 58 HRC
soft-annealed 820 °C	approx. 200 HB
hardened 1050 °C / oil	approx. 58 HRC
tempered 600 °C	approx. 53 HRC
1 layer on non-alloyed steel	approx. 45 HRC

**Typical analysis of rod and wire in %**

C	Si	Mn	Cr	Mo	Ti	Fe
0.35	0.3	1.2	7.0	2.0	0.3	balance

**Welding instructions**

Clean welding area to metallic bright. Cracks in the base material have to be gouged out completely. Preheating temperature of 400 °C on tools should be maintained. Stress relief / annealing is recommended at 550 °C.

**Form of delivery and recommended welding parameters**

Rod diameter x length [mm]	Current type	Shielding gas (EN ISO 14175)
1.6 x 1000	DC (-)	I 1
2.0 x 1000	DC (-)	I 1
2.4 x 1000	DC (-)	I 1
3.2 x 1000	DC (-)	I 1
4.0 x 1000*	DC (-)	I 1

\*available on request

This product is also available as solid wire for MIG/MAG.



## Classifications

TIG rod

EN 14700	DIN 8555	Material-No.
S Z Fe3	W3-GZ-45-T	Special alloy

## Characteristics and field of use

UTP A 73 G 3 is, due to the excellent hot wear resistance and toughness, used for highly stressed hot working tools, which are simultaneously subject to high mechanical, thermal and abrasive loads, such as e.g. forging dies for hammers and presses, forging dies, Al-die cast moulds, plastic moulds, hot-shear blades and for filling engravings by using cheaper base metals.

Machining is possible with tungsten carbide tools.

Hardness of the pure weld deposit:

untreated	42 – 46 HRC
soft-annealed 780 °C	approx. 230 HB
hardened 1030 °C / oil	approx. 48 HRC
tempered 600 °C	approx. 45 HRC
1 layer on non-alloy steel	approx. 35 HRC

## Typical analysis of rod and wire in %

C	Si	Mn	Cr	Mo	Ti	Fe
0.25	0.5	0.7	5.0	4.0	0.6	balance

## Welding instructions

Machine welding area to metallic bright. Cracks in the base material have to be gouged out completely. Preheating temperature of 400 °C on tools should be maintained. Stress relief/annealing is recommended at 550 °C.

## Approvals

TÜV (No. 01896), GL

## Form of delivery and recommended welding parameters

Rod diameter x length [mm]	Current type	Shielding gas (EN ISO 14175)
1.2 x 1000	DC (-)	I 1
1.6 x 1000	DC (-)	I 1
2.0 x 1000	DC (-)	I 1
2.4 x 1000	DC (-)	I 1

This product is also available as solid wire for MIG/MAG.

**UTP A 73 G 4**

Tool steels

**Classifications**

TIG rod

EN 14700

DIN 8555

S Z Fe3

W3-GZ-40-T

**Characteristics and field of use**

UTP A 73 G 4 is, due to its excellent hot wear resistance and toughness, used for build-ups on hot working tools and structural parts subject to impact, compression and abrasion at elevated temperatures, such as forging dies, die cast moulds, plastic moulds, guides, recipients, continuous casting rolls. Hot wear resistant claddings can be made on non-alloy or low-alloy base materials, such as e. g. boiler tubes in coal burning power stations. The deposit is machinable with cutting tools.

UTP A 73 G4 has very good welding properties, good weld build-up and an even flow of the weld pool.

Hardness of the pure weld deposit :

untreated	38 – 42 HRC
soft-annealed 800 °C	approx. 230 HB
hardened 1030 °C / oil	approx. 48 HRC
tempered 550 °C	approx. 42 HRC
1 layer on non-alloy steel	approx. 30 HRC

**Typical analysis of rod and wire in %**

C	Si	Mn	Cr	Mo	Fe
0.1	0.4	0.6	6.5	3.3	balance

**Welding instructions**

Machine welding area to metallic bright. Cracks in the base material have to be gouged out completely. Preheating temperature of 400 °C on tools should be maintained. Stress relief/annealing is recommended at 550 °C. Preheating on non- and low-alloy materials is generally not required.

**Approvals**

TÜV (No. 1896), GL

**Form of delivery and recommended welding parameters**

Rod diameter x length [mm]	Current type	Shielding gas (EN ISO 14175)
1.2 x 1000*	DC (-)	I 1
1.6 x 1000	DC (-)	I 1
2.0 x 1000	DC (-)	I 1
2.4 x 1000	DC (-)	I 1
3.2 x 1000	DC (-)	I 1

\*available on request

This product is also available as solid wire for MIG/MAG.

## Classifications

TIG rod

EN 14700	DIN 8555	Material-No.
S Fe8	WSG 3-60-T	1.2606

## Characteristics and field of use

UTP A 673 is used for the repair and production of hot working tools, such as die cast moulds, forging dies, hot cutting knives, hot-shear blades, axial rolls, roll mandrils, upset plates as well as for the production of working surfaces on non- or low-alloyed base materials.

Machining is possible with tungsten carbide tools.

Hardness of the pure weld deposit:

untreated	53 – 58 HRC
soft-annealed 820 °C	approx. 230 HB
hardened 1050 °C / oil	approx. 53 – 58 HRC
tempered 600 °C	approx. 53 HRC
1 layer on non-alloyed steel	approx. 45 HRC

## Typical analysis of rod and wire in %

C	Si	Mn	Cr	Mo	V	W	Fe
0.35	1.0	0.4	5.0	1.5	0.3	1.3	balance

## Welding instructions

Clean welding area to metallic bright. Cracks in the base material have to be completely gouged out. Pre-heating temperature of 400 °C should be maintained on tools. Stress relief, if necessary, at 550 °C. Slow cooling-down.

## Form of delivery and recommended welding parameters

Rod diameter x length [mm]	Current type	Shielding gas (EN ISO 14175)
1.6 x 1000	DC (-)	I 1
2.4 x 1000	DC (-)	I 1
3.2 x 1000	DC (-)	I 1

## UTP A 696

Tool steels

## Classifications

TIG rod

EN 14700

DIN 8555

Material-No.

S Z Fe4

WSG 4-GZ-60-S

1.3348

## Characteristics and field of use

UTP A 696 is used for the production and repair of tools made of Mo-alloyed high-speed steels, such as cutting knives and planing tools, formcutters, broaching tools, reamers, twist drills etc.

UTP A 696 is suitable for the following base materials:

Material-No	DIN 17007
1.3316	S 9-1-2
1.3333	S 3-3-2
1.3344	S 6-5-3
1.3346	S 2-9-1

Another application field is the production of wear-resistant coatings on un- or low-alloyed base materials.

The weld deposit of UTP A 696 is equivalent to a high-speed steel with high cutting performance. After cooling the weld deposit is only machinable by grinding. Machining with tungsten carbide tools is only possible after soft-annealing.

## Hardness of the pure weld deposit

Untreated:	60 – 64 HRC
Soft-annealed 800 °C:	approx. 250 HB
Hardened 1230 °C (oil) + tempered 540 °C (2x):	62 – 66 HRC

## Typical analysis of rod and wire in %

C	Si	Mn	Cr	Mo	V	W	Fe
1.0	0.2	0.2	4.0	8.5	2.0	1.8	balance

## Welding instructions

Preheating to 350-650 °C, depending on the dimension of the workpiece. This temperature should be maintained during the whole welding process. This rod should be welded with very low amperage settings and subsequent slow cooling to 100 °C in a furnace or under sand.

## Hardness of the pure weld deposit

Hardened:	1190 – 1240 °C, quenchant: oil, warm bath: 450 – 500 °C
Tempered:	450 – 500 °C, 2 x 1 h, cooling in still air
Soft-annealed:	800 – 850 °C, 2 – 4 h

## Form of delivery and recommended welding parameters

Rod diameter x length [mm]	Current type	Shielding gas (EN ISO 14175)
1.6 x 1000	DC (-)	I 1
2.4 x 1000	DC (-)	I 1
3.2 x 1000	DC (-)	I 1

## Classifications

TIG rod

EN 14700	DIN 8555	Material-No.
S Z Fe5	WSG 3-GZ-350-T	1.6356

## Characteristics and field of use

UTP A 702 is used for repair, preventive maintenance and production of highly stressed cold and hot working tools, such as punching dies, cold and hot cutting knives, AI-die cast moulds, cold forging dies, drawing-, stamping- and chamfering tools. The weld deposit is, in as-welded condition, machinable, and the subsequent artificial aging optimises the resistance to hot wear and alternating temperatures.

The weld deposit of UTP A 702 has high strength and good toughness.

Hardness of the pure weld deposit:

untreated	32 – 35 HRC
hot-aged 3 – 4 h / 480 °C :	50 – 54 HRC

## Typical analysis of rod and wire in %

C	Mo	Ni	Co	Ti	Al	Fe
0.02	4.0	18.0	12.0	1.6	0.1	balance

## Welding instructions

Machine welding area to metallic bright finish. Preheat massive pieces to 100 – 150 °C, on low-alloyed base metal apply min. 3 – 4 layers. Weld with lowest possible heat input.

## Form of delivery and recommended welding parameters

Rod diameter x length [mm]	Current type	Shielding gas (EN ISO 14175)
1.2 x 1000*	DC (-)	I 1
1.6 x 1000	DC (-)	I 1
2.0 x 1000	DC (-)	I 1
2.4 x 1000	DC (-)	I 1
3.2 x 1000	DC (-)	I 1

\*available on request

**Classifications**

TIG rod

EN 14700

DIN 8555

Material-No.

S Fe8

WSG 6-GZ-60-S

1.4718

**Characteristics and field of use**

UTP A DUR 600 is a TIG rod for hardfacing components which are subject to high impact and medium abrasion. Main applications are quarries, crushing plants, mines, steel works and cement works, as well as cutting tools and dies in the automotive industry.

**Properties of the weld metal**

Despite the high hardness, the weld deposit of UTP A DUR 600 is tough, crack-resistant and has a good cutting capacity. Machining is possible by grinding.

**Hardness of the pure weld deposit**

As welded: 54 – 60 HRC

Soft-annealed 800 °C: approx. 250 HB

Hardened 1000 °C / oil: approx. 62 HRC

1 layer on non-alloyed steel: approx. 53 HRC

**Typical analysis of rod and wire in %**

C	Si	Mn	Cr	Fe
0.5	3.0	0.5	9.5	balance

**Welding instructions**

Grind the welding area to a bright metallic finish.

Tool steels should be preheated to 250 – 450 °C, depending on base metal, application and requirements.

**Form of delivery and recommended welding parameters**

Rod diameter x length [mm]	Current type	Shielding gas (EN ISO 14175)
1.0 x 1000 mm*	DC (-)	I 1
1.2 x 1000 mm*	DC (-)	I 1
1.6 x 1000 mm	DC (-)	I 1
2.0 x 1000 mm	DC (-)	I 1
2.4 x 1000 mm	DC (-)	I 1
3.0 x 1000 mm	DC (-)	I 1

\* available on request

## TIG rods for repair of cracked material

### 7. Cobalt-based alloys

Product name	EN ISO		AWS		Page
UTP A Celsit 706 V	14700	R Z Co2	A 5.21	ER CoCr-A	142
UTP A Celsit 712 SN	14700	R Co3	A 5.21	~ ER CoCr-B	143
UTP A Celsit 721	14700	R Z Co1	A 5.21	ER CoCr-E	144

#### Solution examples



*Hot cutting tool*

UTP A Celsit 706

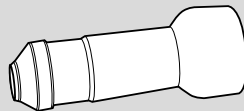

*Hot piercing tool / Piercer*

UTP A Celsit 721

**Classifications**

TIG rod

EN 14700

DIN 8555

AWS A 5.21

R Z Co2

WSG 20-GO-40-CSTZ

ER CoCr-A

**Characteristics and field of use**

UTP A CELSIT 706 V is suitable for hardfacing of parts subject to a combination of erosion, corrosion, cavitation, pressure, impact, abrasion and high heat up to 900 °C, such as tight surfaces of fittings, valve seats and cones for combustion engines, gliding surfaces metal to metal, highly stressed hot working tools without thermal shock, milling, mixing and drilling tools.

Excellent gliding characteristics, very good polishability, high toughness, non-magnetic. Machinable by grinding and with tungsten carbide tools.

Hardness of pure weld deposit: 40 – 42 HRC

Hardness at 500 °C: approx. 33 HRC

**Typical analysis of rod and wire in %**

C	Cr	W	Co
1.2	27.0	4.5	balance

**Welding instructions**

Clean welding area, preheating temperature 450 – 600 °C, very slow cooling.

**Form of delivery and recommended welding parameters**

<i>Rod diameter x length [mm]</i>	<i>Current type</i>	<i>Shielding gas (EN ISO 14175)</i>
2.4 x 1000 mm*	DC (-)	I 1
3.2 x 1000 mm	DC (-)	I 1
4.0 x 1000 mm	DC (-)	I 1
5.0 x 1000 mm	DC (-)	I 1

Adjust acetylene excess (reducing flame) in oxyacetylene welding.

\* Available on demand.



## Classifications

TIG rod

EN 14700	DIN 8555	AWS A 5.21
R Co3	WSG 20-GO-50-CSTZ	~ER CoCr-B

## Characteristics and field of use

UTP A CELSIT 712 SN is suitable for highly wear resistant hardfacing of parts subject to a combination of abrasion, erosion, corrosion, cavitation, pressure and high temperatures up to 900 °C, such as sealing and gliding surfaces of fittings and pumps, valve seats and cones for combustion engines, tools for wood, paper and plastic industries, gliding surfaces metal to metal, milling, mixing and drilling tools, heavy-duty hot work tools without thermal shock.

Excellent gliding characteristics, good polishability, non-magnetic. Machinable by grinding and with tungsten carbide tools.

Hardness of pure weld deposit: 48 – 50 HRC

Hardness at 500 °C: approx. 40 HRC

## Typical analysis of rod and wire in %

C	Cr	W	Co
1.8	29.0	8.5	balance

## Welding instructions

Clean welding area, preheating temperature 500 – 600 °C, very slow cooling.

## Form of delivery and recommended welding parameters

Rod diameter x length [mm]	Current type	Shielding gas (EN ISO 14175)
3.2 x 1000 mm	DC (-)	I 1
4.0 x 1000 mm	DC (-)	I 1
5.0 x 1000 mm*	DC (-)	I 1

Adjust acetylene excess (reducing flame) in oxyacetylene welding.

\* Available on demand.

**Classifications**

TIG rod

EN 14700

DIN 8555

AWS A 5.21

R Z Co1

G/MSG 20-G0-300-CKTZ

ER CoCr-E

**Characteristics and field of use**

UTP A CELSIT 721 is a CoCrMo-alloyed rod for TIG and gas welding and especially suitable for hardfacing of parts subject to a combination of pressure, impact, abrasion, corrosion and high temperatures up to 900 °C, such as running and sealing faces of gas-, water-, steam- and acid fittings and pumps; valve seats and cones for combustion engines; working parts on turbines and power plants; hot-working tools with frequent changes of high thermal load.

Properties of the weld metal

Excellent gliding characteristics, very good polishability, high toughness, non-magnetic.

Hardness of the pure weld deposit: 30 – 32 HRC  
 Work-hardened: approx. 45 HRC  
 Hardness at 600 °C: approx. 240 HB

**Typical analysis of rod and wire in %**

C	Cr	Mo	Ni	Co
0.25	28.0	5.0	2.8	balance

**Welding instructions**

Clean welding area, preheat to 150 – 400 °C, depending on size of the workpiece and base material. Slow cooling.

**Form of delivery and recommended welding parameters**

Rod diameter x length [mm]	Current type	Shielding gas (EN ISO 14175)
2.4 x 1000 mm	DC (-)	I 1
3.2 x 1000 mm	DC (-)	I 1
4.0 x 1000 mm	DC (-)	I 1

Adjust acetylene excess (reducing flame) in oxyacetylene welding.



## List of contents

### GMAW – solid wires

<b>Description of the GMAW process</b>	<b>147</b>
<b>Solid wires for repair of cracked material</b>	<b>148</b>
1. Unalloyed and low alloyed steels	148
2. Stainless steels	153
3. Nickel alloys	163
4. Cast iron	178
5. Copper alloys	180
<b>Surfacing solid wires for anti-wear and anti-corrosion applications</b>	<b>190</b>

## Description of the GMAW process

*MIG = Metal Inert Gas*  
*MAG = Metal Active Gas*

**Metal shielding gas welding is an economic welding procedure which is well-suited to uniform welding sequences.**

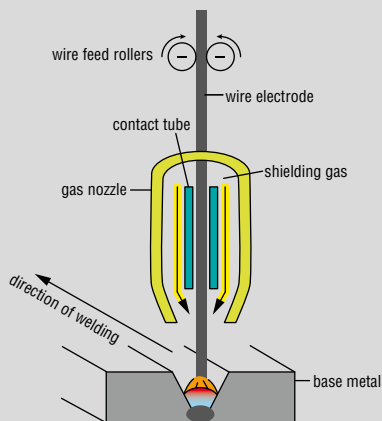

The weld metal demonstrates good properties, and the method features high productivity, whether applied manually or automatically.

The arc burns between the welding wire and the workpiece in gas shielded metal arc welding. The solid wire is automatically fed through the centre of the welding torch. The shielding gas is also passed through the welding torch, and encloses the weld pool during the welding process. The weld seam is therefore shielded from the surroundings. The gases used in MAG welding are active. Carbon dioxide, or a gas mixture, is used. In practice, MAG welding under a mixture of gases has prevailed, as it has a lower tendency to spatter and a higher deposition rate than welding using 100 % carbon dioxide.

In MIG welding, inert gases such as argon, helium, and their mixtures are used. These shielding gases do not react with either the base materials or the welding consumables.

The MSG method can be used with a wide range of materials, welding position and degrees of mechanisation. It permits welding with a manually held torch as well as fully automated robot methods. The deposition rate is very high, and productivity is high too.

## Solid wires for repair of cracked material

### 1. Unalloyed and low alloyed steels

Product name	EN ISO		AWS		Mat. - No.	Page
UTP A 118	14341-A	G 42 2 C1 3Si1	A5.18	ER 70S-G		149
UTP A 119	14341-A	G 46 2 C1 4Si1	A5.18	ER 70S-6		150
UTP A 641	21952-A	G CrMo1Si	A5.28	ER 80S-G	1.7339	151
UTP A 643	16834-A	G 69 6 M21 Mn4Ni1.5CrMo	A5.28	ER 100S-G		152

#### Solution examples

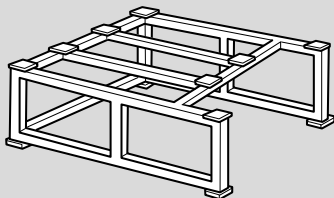

*Steel construction repair*

UTP A 118

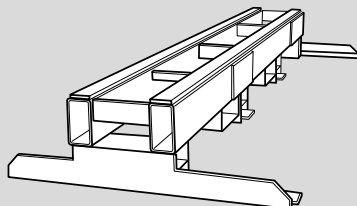

*Steel construction repair*

UTP A 119

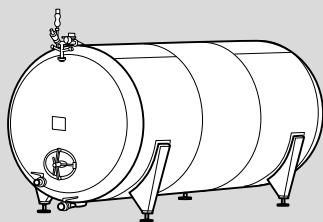

*Vessel*

UTP A 641

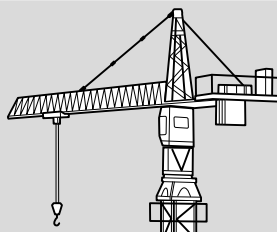

*Crane construction repair*

UTP A 643

<b>Classifications</b>		solid wire
EN ISO 14341-A	AWS A5.18	
G 42 2 C1 3Si1 / G 46 4 M21 3Si1	ER70S-6	

### Characteristics and field of use

GMAW solid wire electrode for welding unalloyed and low alloy steels with shielding gas. All-purpose useable with gas mixture or CO<sub>2</sub>, low-spatter transfer in the short and spray arc range. Used in boiler and pipeline construction, shipbuilding, vehicle manufacturing and structural engineering.

### Base materials

S235JRG2 – S355J2; boiler steels P235GH, P265GH, P295GH; fine grained structural steels up to S420N and armour steels. ASTM A27 u. A36 Gr. all; A106 Gr. A, B; A214; A242 Gr. 1-5; A266 Gr. 1, 2, 4; A283 Gr. A, B, C, D; A285 Gr. A, B, C; A299 Gr. A, B; A328; A366; A515 Gr. 60, 65, 70; A516 Gr. 55; A556 Gr. B2A; A570 Gr. 30, 33, 36, 40, 45; A572 Gr. 42, 50; A606 Gr. alle; A607 Gr. 45; A656 Gr. 50, 60; A668 Gr. A, B; A907 Gr. 30, 33, 36, 40; A851 Gr. 1, 2; A935 Gr. 45; A936 Gr. 50

### Typical analysis in %

C	Si	Mn
0.08	0.85	1.50

### Mechanical properties of the weld metal

Heatreatment	Shielding gas	0.2%-Yield strength	Tensile strength	Elongation (L <sub>0</sub> =5d <sub>0</sub> )	Impact values CVN		
		MPa	MPa	%	J	-20 °C	-40 °C
AW	CO <sub>2</sub>	420	540	25	85	47	
AW	M 21	440	560	24	95	60	47

### Approvals

TÜV (No. 00106), DB (No. 42.132.02), ABS, DNV GL, LR

### Form of delivery and recommended welding parameters

Wire diameter [mm]	Current type	Shielding gas (EN ISO 14175)			
0.8	DC (+)	M 1	M 2	M 3	C 1
1.0	DC (+)	M 1	M 2	M 3	C 1
1.2	DC (+)	M 1	M 2	M 3	C 1
1.6	DC (+)	M 1	M 2	M 3	C 1

Other spool types on request.

## UTP A 119

Unalloyed and low alloyed steels

## Classifications

solid wire

EN ISO 14341-A

AWS A5.18

G 46 2 C1 4Si1 / G 46 4 M21 4Si1

ER70S-6

## Characteristics and field of use

GMAW solid wire electrode for welding unalloyed and low alloy steels with CO<sub>2</sub> or gas mixture.

Low spatter transfer in short and spray arc range. High arc stability also at high welding current amperage. Large application range; specially suited for steels of higher strength in boiler and pipeline construction, shipbuilding, vehicle manufacturing and structural engineering.

## Base materials

S235JRG2 – S355J2; boiler steels P235GH, P265GH, P295GH, P355GH; fine grained structural steels up to S460N; ASTM A27 u. A36 Gr. alle; A106 Gr. A, B; A214; A242 Gr. 1-5; A266 Gr. 1, 2, 4; A283 Gr. A, B, C, D; A285 Gr. A, B, C; A299 Gr. A, B; A328; A366; A515 Gr. 60, 65, 70; A516 Gr. 55; A556 Gr. B2A; A570 Gr. 30, 33, 36, 40, 45; A572 Gr. 42, 50; A606 Gr. all; A607 Gr. 45; A656 Gr. 50, 60; A668 Gr. A, B; A907 Gr. 30, 33, 36, 40; A851 Gr. 1, 2; A935 Gr. 45; A936 Gr. 50

## Typical analyses in %

C	Si	Mn
0.08	1.05	1.65

## Mechanical properties of the weld metal

Heat-treatment	Shielding gas	0.2%-Yield strength	Tensile strength	Elongation (L <sub>0</sub> =5d <sub>0</sub> )	Impact values CVN		
		MPa	MPa	%	J	-20 °C	-40 °C
AW	CO <sub>2</sub>	450	550	25	90	47	
AW	M 21	480	580	24	95	65	47

## Approvals

TÜV (No. 00376), ABS, BV, DNV GL, LR

## Form of delivery and recommended welding parameters

Wire diameter [mm]	Current type	Shielding gas (EN ISO 14175)		
0.8	DC (+)	M 2	M 3	C 1
1.0	DC (+)	M 2	M 3	C 1
1.2	DC (+)	M 2	M 3	C 1
1.6	DC (+)	M 2	M 3	C 1

Other spool types on request.



## Classifications solid wire

EN ISO 21952-A	AWS A5.28	Material-No.
G CrMo1Si	ER80S-G	1.7339

## Characteristics and field of use

Medium alloy solid wire electrode useable both with CO<sub>2</sub> and with gas mixture. Applications include the welding of creep resistant steels in boiler, tank, pipeline and reactor construction.

## Base materials

1.7335 – 13CrMo4-5; ASTM A193 Gr. B7; A335 Gr. P11 and P12;  
1.7357 – G17CrMo5-5 – A217 Gr. WC6

## Typical analysis in %

C	Si	Mn	Cr	Mo
0.09	0.6	1.05	1.1	0.5

## Mechanical properties of the weld metal

Heat-treatment	Shielding gas	0.2 %-Yield strength	Tensile strength	Elongation (L <sub>0</sub> =5d <sub>0</sub> )	Impact values CVN
		MPa	MPa	%	J
A	M 21*	450	560	22	80

\*) Also weldable with CO<sub>2</sub>.  
In this case the mechanical properties will change.

## Approvals

TÜV (No. 00905), DB (No. 42.132.19)

## Form of delivery and recommended welding parameters

Wire diameter [mm]	Current type	Shielding gas (EN ISO 14175)			
0.8	DC (+)	M 1	M 2	M 3	C 1
1.0	DC (+)	M 1	M 2	M 3	C 1
1.2	DC (+)	M 1	M 2	M 3	C 1

Other spool types on request.

**Classifications** solid wire

EN ISO 16834-A	AWS A5.28
G 69 6 M21 Mn4Ni1.5CrMo	ER100S-G [ER100S-1(mod.)]

**Characteristics and field of use**

Medium alloy solid wire electrode for shielded arc welding of quenched and tempered and thermomechanically treated fine grained structural steels; for joint welding of wear resistant steels. For use with CO<sub>2</sub> and gas mixture. Outstanding toughness of the weld metal at low temperatures. For use in crane and vehicle manufacturing.

**Base materials**

S690QL1 (alform 700 M; aldur 700 QL1; Dillimax 690; N-A-XTRA 70; Weldox 700),  
 S620QL1 (Dillimax 620; N-A-XTRA 63),  
 S700MC (alform 700 M; Domex 700 MC; PAS 70)

**Typical analysis in %**

C	Si	Mn	Cr	Mo	Ni
0.08	0.6	1.7	0.2	0.5	1.5

**Mechanical properties of the weld metal**

Heat treatment	Shielding gas	0.2%-Yield strength	Tensile strength	Elongation (L <sub>0</sub> =5d <sub>0</sub> )	Impact values CVN		
		MPa	MPa	%	J	- 40 °C	- 60 °C
U	CO <sub>2</sub>	680	740	18	80	47	
U	M 21	720	780	16	100		47

**Approvals**

TÜV (No. 02760), DB (No. 42.132.08), ABS, BV, DNV GL, LR

**Form of delivery and recommended welding parameters**

Wire diameter [mm]	Current type	Shielding gas (EN ISO 14175)	
0.8	DC (+)	M 21	C 1
1.0	DC (+)	M 21	C 1
1.2	DC (+)	M 21	C 1

Other spool types on request.

## Solid wires for repair of cracked material

### 2. Stainless steels

Product name	EN ISO	AWS	Mat.-No.	Page
UTP A 63	14343-A G 18 8 Mn	A5.9 ER307 (mod.)	1.4370	154
UTP A 68	14343-A G 19 9 Nb Si	A5.9 ER 347 (Si)	1.4551	155
UTP A 68 LC	14343-A G 19 9 L (Si)	A5.9 ER 308 L (Si)	1.4316	156
UTP A 68 Mo	14343-A G 19 12 3 Nb (Si)	A5.9 ER 318 (Si)	1.4576	157
UTP A 68 MoLC	14343-A G 19 12 3 L (Si)	A5.9 ER 316 L (Si)	1.4430	158
UTP A 651	14343-A G 29 9	A5.9 ER 312	1.4337	159
UTP A 6635	14343-A G 13 4 (Si)	A5.9 ~ER 410 NiMo	1.4351	160
UTP A 6808 Mo	14343-A G 22 9 3 N L	A5.9 ER 2209	~1.4462	161
UTP A 6824 LC	14343-A G 23 12 L (Si)	A5.9 ER 309 L (Si)	1.4332	162

#### Solution examples

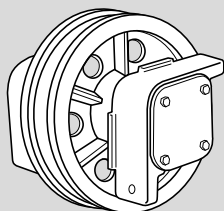

*Crane wheel*

UTP A 63

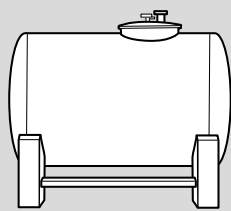

*Pressure vessel*

UTP A 68 LC

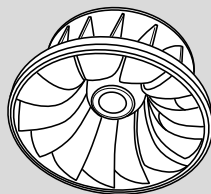

*Turbine*

UTP A 6635

**Classifications**

solid wire

EN ISO 14343-A

AWS A5.9

Material-No.

G 18 8 Mn

ER 307 (mod.)

1.4370

**Characteristics and field of use**

UTP A 63 is suitable for particularly crack resistant joining and surfacing of high-strength ferritic and austenitic steels, hard manganese steels and cold-tough steels, as cushioning layer under hard alloys, dissimilar metal joints.

The weld metal of UTP A 63 is scale resistant up to 850 °C, cold-tough to – 110 °C. Work hardening.

Hardness of the pure weld metal: approx. 200 HB

**Typical analysis in %**

C	Si	Mn	Cr	Ni	Fe
0.08	0.8	6.5	19.5	9.0	balance

**Mechanical properties of the weld metal**

<i>Yield strength <math>R_{p0.2}</math></i>	<i>Tensile strength <math>R_m</math></i>	<i>Elongation <math>A</math></i>
<i>MPa</i>	<i>MPa</i>	<i>%</i>
> 370	> 600	> 30

**Welding instructions**

Clean weld area thoroughly. Thick walled, ferritic elements have to be preheated to approx. 150 – 250 °C.

**Approvals**

TÜV (No. 04096), DB (No. 43.132.58)

**Form of delivery and recommended welding parameters**

<i>Wire diameter [mm]</i>	<i>Current type</i>	<i>Shielding gas (EN ISO 14175)</i>
0.8	DC (+)	M 12
1.0	DC (+)	M 12
1.2	DC (+)	M 12
1.6	DC (+)	M 12

## Classifications

solid wire

EN ISO 14343-A	AWS A5.9	Material-No.
G 19 9 Nb Si	ER 347 (Si)	1.4551

## Characteristics and field of use

UTP A 68 is suitable for joining and surfacing in chem. apparatus and vessel construction for working temperatures of  $-196^{\circ}\text{C}$  up to  $400^{\circ}\text{C}$ .

## Base materials

1.4550	X6 CrNiNb 18-10
1.4541	X6CrNiTi 18-10
1.4552	G-X5 CrNiNb 18-10
1.4311	X2 CrNiN 18-10
1.4306	X2 CrNi 19-11

AlSi 347, 321, 302, 304, 304LN

ASTM A 296 Gr. CF 8 C, A 157 Gr. C 9

## Typical analysis in %

C	Si	Mn	Cr	Ni	Nb	Fe
0.05	0.65 – 1.0	1.5	19.5	9.5	0.55	balance

## Mechanical properties of the weld metal

<i>Yield strength <math>R_{p0.2}</math></i>	<i>Tensile strength <math>R_m</math></i>	<i>Elongation <math>A</math></i>	<i>Impact strength <math>K_V</math></i>
<i>MPa</i>	<i>MPa</i>	<i>%</i>	<i>J (RT)</i>
420	600	30	100

## Welding instructions

Degrease and clean weld area thoroughly (metallic bright).  
Preheating and post heat treatment are usually not necessary.

## Approvals

TÜV (No. 04865)

## Form of delivery and recommended welding parameters

<i>Wire diameter [mm]</i>	<i>Current type</i>	<i>Shielding gas (EN ISO 14175)</i>	
0.8	DC (+)	M 11	M 12
1.0	DC (+)	M 11	M 12
1.2	DC (+)	M 11	M 12

**Classifications**

solid wire

EN ISO 14343-A

AWS A5.9

Material-No.

G 19 9 L (Si)

ER 308 L (Si)

1.4316

**Characteristics and field of use**

UTP A 68 LC is suitable for joining and surfacing in chem. apparatus and vessel construction for working temperatures of – 196 °C up to 350 °C.

**Base materials**

1.4306 X2 CrNi 19-11  
 1.4311 X2 CrNiN 18-10  
 1.4312 G-X10 CrNi 18-8  
 1.4541 X6 CrNiTi 18-10  
 1.4546 X5 CrNiNb 18-10  
 1.4550 X6 CrNiNb 18-10

AISI 304; 304L; 302; 321; 347  
 ASTM A 1576 Gr. C 9; A 320 Gr. B 8 C oder D

**Typical analysis in %**

C	Si	Mn	Cr	Ni	Fe
0.02	0.65 – 1.0	1.5	20.0	10.0	balance

**Mechanical properties of the weld metal**

Yield strength $R_{p0.2}$	Tensile strength $R_m$	Elongation A	Impact strength $K_v$
MPa	MPa	%	J (RT)
400	600	35	100

**Approvals**

TÜV (No. 00184)

**Form of delivery and recommended welding parameters**

Wire diameter [mm]	Current type	Shielding gas (EN ISO 14175)		
0.8	DC (+)	M 11	M 12	M 13
1.0	DC (+)	M 11	M 12	M 13
1.2	DC (+)	M 11	M 12	M 13

## Classifications

solid wire

EN ISO 14343-A	AWS A5.9	Material-No.
G 19 12 3 Nb (Si)	ER 318 (Si)	1.4576

## Characteristics and field of use

UTP A 68 Mo is applicable for joinings and surfacings of stabilized, corrosion resistant CrNiMo steels of similar nature in the construction of chemical apparatus and vessels up to working temperatures of 120 °C up to 400 °C.

## Base materials

1.4404	X2 CrNiMo 17-12-2
1.4435	X2 CrNiMo 18-14-3
1.4436	X3 CrNiMo 17-13-3
1.4571	X6 CrNiMoTi 17-12-2
1.4580	X6 CrNiMoNb 17-12-2
1.4583	X10 CrNiMoNb 18-12
1.4409	G-X2 CrNiMo 19-112

UNS S31653; AISi 361L; 316Ti; 316Cb

## Typical analysis in %

C	Si	Mn	Cr	Mo	Ni	Nb	Fe
0.03	0.65 – 1.0	1.5	19.0	2.8	11.5	0.55	balance

## Mechanical properties of the weld metal

Yield strength $R_{p0.2}$	Tensile strength $R_m$	Elongation $A$	Impact strength $K_V$
MPa	MPa	%	J (RT)
460	680	35	100

## Welding instructions

Degrease and clean weld area thoroughly (metallic bright).  
Preheating and post heat treatment are usually not necessary.

## Approvals

TÜV (No. 04867)

## Form of delivery and recommended welding parameters

Wire diameter [mm]	Current type	Shielding gas (EN ISO 14175)		
0.8	DC (+)	M 11	M 12	M 13
1.0	DC (+)	M 11	M 12	M 13
1.2	DC (+)	M 11	M 12	M 13

## Classifications

solid wire

EN ISO 14343-A

AWS A5.9

Material-No.

G 19 12 3 L (Si)

ER 316 L (Si)

1.4430

## Characteristics and field of use

UTP A 68 MoLC is used for joining and surfacing of low-carbon, corrosion resistant CrNiMo steels exposed to high corrosion environments. For service temperatures up to +350 °C. Application fields are chemical apparatus and vessels.

## Base materials

1.4401	X5 CrNiMo 17-12-2
1.4404	X2 CrNiMo 17-12-2
1.4435	X2 CrNiMo 18-14-3
1.4436	X3 CrNiMo 17-13-3
1.4571	X6 CrNiMoTi 17-12-2
1.4580	X6 CrNiMoNb 17-12-2
1.4583	X10 CrNiMoNb 18-12
1.4409	GX2 CrNiMo 19-11-2

S31653, AISi 316 L, 316 Ti, 316 Cb

## Typical analysis in %

C	Si	Mn	Cr	Mo	Ni	Fe
0.02	0.65 – 1.0	1.5	18.5	2.8	12.0	balance

## Mechanical properties of the weld metal

Yield strength $R_{p0.2}$	Tensile strength $R_m$	Elongation $A$	Impact strength $K_v$
MPa	MPa	%	J (RT)
420	600	35	100

## Welding instructions

Degrease and clean weld area thoroughly (metallic bright).  
Preheating and post heat treatment are usually not necessary.

## Approvals

TÜV (No. 00188), GL

## Form of delivery and recommended welding parameters

Wire diameter [mm]	Current type	Shielding gas (EN ISO 14175)		
0.8	DC (+)	M 11	M 12	M 13
1.0	DC (+)	M 11	M 12	M 13
1.2	DC (+)	M 11	M 12	M 13



## Classifications

solid wire

EN ISO 14343-A	AWS A5.9	Material-No.
G 29 9	ER 312	1.4337

## Characteristics and field of use

UTP A 651 is suitable for joining and surfacing of steels of difficult weldability, repair of hot and cold working steels, cushioning layers.

The weld metal of UTP A 651 is scale resistant up to 1150 °C. Crack and wear resistant, stainless and work hardening.

Hardness of the pure weld metal: approx. 240 HB.

## Typical analysis in %

C	Si	Mn	Cr	Ni	Fe
0.1	0.4	1.6	30.0	9.0	balance

## Mechanical properties of the weld metal

Yield strength $R_{p0.2}$	Tensile strength $R_m$	Elongation $A$	Impact strength $K_V$
MPa	MPa	%	J (RT)
650	750	25	27

## Welding instructions

Clean weld area thoroughly. High carboned and solid work pieces depending on shape and size have to be preheated up to 150 – 250 °C. Steady guidance during welding process.

## Form of delivery and recommended welding parameters

Wire diameter [mm]	Current type	Shielding gas (EN ISO 14175)	
0.8*	DC (+)	M 12	M 13
1.0*	DC (+)	M 12	M 13
1.2	DC (+)	M 12	M 13

\*available on request

**UTP A 6635**

stainless steels

**Classifications**

solid wire

EN ISO 14343-A

AWS A5.9

Material-No.

G 13 4 (Si)

~ ER 410 NiMo

1.4351

**Characteristics and field of use**

UTP A 6635 is used for joining and building up on identical and similar martensitic CrNi cast steels for the water turbine- and compressor construction with steels.

The weld deposit of UTP A 6635 is stainless and corrosion resistant as 13 %-Cr(Ni)-steels. It presents a high resistance to corrosion fatigue.

**Base materials**

1.4317	G-X4 CrNi 13-4
1.4313	X3 CrNiMo 13-4
1.4351	X3 CrNi 13-4
1.4414	G-X4 CrNiMo 13-4

ACI Gr. CA6NM

**Typical analysis in %**

C	Si	Mn	Cr	Mo	Ni	Fe
0.03	0.7	0.7	13.5	0.55	4.5	balance

**Mechanical properties of the weld metal**

Yield strength $R_{p0.2}$	Tensile strength $R_m$	Elongation $A$	Impact strength $K_v$
MPa	MPa	%	J (RT)
> 600	> 800	15	> 40

**Welding instructions**

For similar materials up to 10 mm wall thickness, preheating is not necessary. From 10 mm wall thickness and up, preheating at 100 – 150 °C should be provided.

**Form of delivery and recommended welding parameters**

Wire diameter [mm]	Current type	Shielding gas (EN ISO 14175)
1.2	DC (+)	M 12

# UTP A 6808 Mo

stainless steels

## Classifications

solid wire

EN ISO 14343-A	AWS A5.9	Material-No.
G 22 9 3 N L	ER 2209	~ 1.4462

## Characteristics and field of use

UTP A 6808 Mo is used for joining and surfacing of corrosion resistant steels as well as cast steel with austenitic-ferritic structure (Duplex steel). Working temperature: up to 250°C.

The weld deposit of UTP A 6808 Mo has an excellence resistance against pitting and stress corrosion cracking next to high strength- and toughness-properties. Very good weld- and flow characteristics.

## Base materials

1.4462	X2 CrNiMoN 22-5-3	
1.4362	X2 CrNiN 23-4	
1.4462	X2 CrNiMoN 22-5-3 with 1.4583	X10 CrNiMoNb 18-12
1.4462	X2 CrNiMoN 22-5-3 with P2356H / P265GH / S255H / P2956H / S355N / 16Mo3	

UNS S31803; S32205

## Typical analysis in %

C	Si	Mn	Cr	Mo	Ni	N	Fe
0.015	0.35	1.5	22.8	3.0	9.0	0.14	balance

## Mechanical properties of the weld metal

<i>Yield strength <math>R_{p0.2}</math></i>	<i>Tensile strength <math>R_m</math></i>	<i>Elongation <math>A</math></i>	<i>Impact strength <math>K_V</math></i>
<i>MPa</i>	<i>MPa</i>	<i>%</i>	<i>J (RT)</i>
600	800	30	80

## Welding instructions

Welding area must be thoroughly cleaned to metallic bright and degreased. Preheating and post heat treatment are usually not necessary. The interpass temperature should not exceed 150°C.

## Approvals

TÜV (No. 05551), GL

## Form of delivery and recommended welding parameters

<i>Wire diameter [mm]</i>	<i>Current type</i>	<i>Shielding gas (EN ISO 14175)</i>
1.0	DC (+)	M 12
1.2	DC (+)	M 12

## UTP A 6824 LC

stainless steels

## Classifications

solid wire

EN ISO 14343-A

AWS A5.9

Material-No.

G 23 12 L (Si)

ER 309 L (Si)

1.4332

## Characteristics and field of use

UTP A 6824 LC ist used for joining and surfacing in chem. apparatus and vessel construction for working temperatures up to +300 °C. Weld cladding of non- and low-alloyed base materials. Dissimilar joints.

## Base materials

1.4306	X2 CrNi 19-11
1.4401	X5 CrNiMo 17-12-2
1.4404	X2 CrNiMo 17-13-2
1.4541	X6 CrNiTi 18-10
1.4550	X6 CrNiNb 18-10
1.4571	X6 CrNiMoTi 17-12-2
1.4580	X6 CrNiMoNb 17-12-2

Joining these materials with unalloyed and low-alloyed steels is possible.

## Typical analysis in %

C	Si	Mn	Cr	Ni	Fe
0.02	0.65-1.0	1.8	23.0	13.5	balance

## Mechanical properties of the weld metal

Yield strength $R_{p0.2}$	Tensile strength $R_m$	Elongation A	Impact strength $K_V$
MPa	MPa	%	J (RT)
400	590	30	140

## Welding instructions

Welding area must be thoroughly cleaned to metallic bright and degreased. Heat-resistant Cr-steels or cast steels have to be preheated according to the base metal. No preheating for similar austenitic steels.

## Approvals

TÜV (No. 05392)

## Form of delivery and recommended welding parameters

Wire diameter [mm]	Current type	Shielding gas (EN ISO 14175)	
0.8*	DC (+)	M 12	M 13
1.0	DC (+)	M 12	M 13
1.2	DC (+)	M 12	M 13

\*available on request

## Solid wires for repair of cracked material

### 3. Nickel alloys

Product name	EN ISO		AWS		Mat.-No.	Page
UTP A 80 M	18274	S Ni 4060	A5.14	ER NiCu-7	2.4377	164
UTP A 80 Ni	18274	S Ni 2061	A5.14	ER Ni-1	2.4155	165
UTP A 068 HH	18274	S Ni 6082	A5.14	ER NiCr-3	2.4806	166
UTP A 759	18274	S Ni 6059	A5.14	ER NiCrMo-13	2.4607	167
UTP A 776	18274	S Ni 6276 (NiCr15Mo16Fe6W4)	A5.14	ER NiCrMo-4	2.4886	168
UTP A 786	18274	S Ni 6686 (NiCr21Mo16W4)	A5.14	ER NiCrMo-14		169
UTP A 2133 Mn	14343	GZ 21 33 Mn Nb			~1.4850	170
UTP A 2535 Nb	14343	GZ 25 35 Zr			1.4853	171
UTP A 3545 Nb	18274	S Ni Z (NiCr36Fe15Nb0.8)				172
UTP A 4221	18274	S Ni 8065 (NiFe30Cr21Mo3)	A5.14	ER NiFeCr-1 (UNS N08065)		173
UTP A 6222 Mo	18274	S Ni 6625	A5.14	ER NiCrMo-3	2.4831	174
UTP A 6222 Mo-3	18274	S Ni 6625 (NiCr22Mo9Nb)	A5.14	ER NiCrMo-3	2.4831	175
UTP A 6225 AL	18274	S Ni 6025	A5.14	ER NiCrFe-12	2.4649	176
UTP A 8036 S	Special alloy					177

#### Solution examples

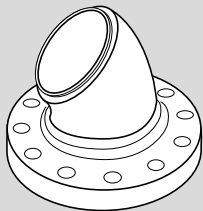

Flange

UTP A 80 M

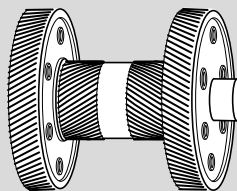

Gear wheel

UTP A 068 HH

## UTP A 80 M

nickel alloys

## Classifications

solid wire

EN ISO 18274	AWS A5.14	Material-No.
S Ni 4060 (NiCu30Mn3Ti)	ER NiCu-7	2.4377

## Characteristics and field of use

UTP A 80 M is suitable for joining and surfacing of nickel-copper alloys and of nickel-copper-clad steels. Particularly suited for the following materials: 2.4360 NiCu30Fe, 2.4375 NiCu30Al.

UTP A 80 M is also used for joining different materials, such as steel to copper and copper alloys, steel to nickel-copper alloys. These materials are employed in high-grade apparatus construction, primarily for the chemical and petrochemical industries. A special application field is the fabrication of seawater evaporation plants and marine equipment.

The weld metal has an excellent resistance to a large amount of corrosive medias, from pure water to nonoxidising mineral acids, alkali and salt solutions.

## Typical analysis in %

C	Si	Mn	Cu	Ni	Ti	Fe
< 0.02	0.3	3.2	29.0	balance	2.4	1.0

## Mechanical properties of the weld metal according to EN ISO 15792-1 (min. values at RT)

Yield strength $R_{p0.2}$	Tensile strength $R_m$	Elongation $A$	Impact strength $K_v$
MPa	MPa	%	J (RT)
> 300	> 480	> 30	> 80

## Welding instructions

Clean the weld area thoroughly to avoid porosity. Opening groove angle about 70 °. Weld stringer beads.

## Approvals

TÜV (No. 00250), ABS, GL

## Form of delivery and recommended welding parameters

Wire diameter [mm]	Current type	Shielding gas (EN ISO 14175)		
0.8*	DC (+)	I 1	I 3	Z-ArHeHC-30 / 2 / 0.05
1.0	DC (+)	I 1	I 3	Z-ArHeHC-30 / 2 / 0.05
1.2	DC (+)	I 1	I 3	Z-ArHeHC-30 / 2 / 0.05

\*available on request

# UTP A 80 Ni

nickel alloys

## Classifications

solid wire

EN ISO 18274	AWS A5.14	Material-No.
S Ni 2061 (NiTi3)	ER Ni-1	2.4155

## Characteristics and field of use

UTP A 80 Ni is suited for joining and surfacing on commercial pure nickel grades, including LC nickel, nickel alloys and nickel-clad steels.

Such materials are employed primarily in the construction of pressure vessels and apparatus in the chemical industry, in the food industry and for power generation, where good behaviour under corrosion and temperature is demanded.

The weld metal has an excellent resistance in a lot of corrosive medias, from acid to alkali solutions.

## Typical analysis in %

C	Si	Mn	Ni	Ti	Fe
< 0.02	< 0.3	0.3	balance	3.3	< 0.1

## Mechanical properties of the weld metal

Yield strength $R_{p0.2}$	Tensile strength $R_m$	Elongation $A$	Impact strength $K_V$
MPa	MPa	%	J (RT)
> 300	> 450	> 30	> 160

## Welding instructions

Clean the weld area thoroughly to avoid porosity. Groove angle about 70 °.  
To be welded by stringer bead technique.

## Approvals

TÜV (No. 00950), ABS

## Form of delivery and recommended welding parameters

Wire diameter [mm]	Current type	Shielding gas (EN ISO 14175)		
0.8	DC (+)	1 1	1 3	Z-ArHe- HC-30 / 2 / 0.05
1.0	DC (+)	1 1	1 3	Z-ArHe- HC-30 / 2 / 0.05
1.2	DC (+)	1 1	1 3	Z-ArHe- HC-30 / 2 / 0.05

## Classifications

solid wire

EN ISO 18274	AWS A5.14	Material-No.
S Ni 6082 (NiCr20Mn3Nb)	ER NiCr-3	2.4806

## Characteristics and field of use

UTP A 068 HH is predominantly used for joining identical or similar high heat resistant Ni-base alloys, heat resistant austenites, and for joining heat resistant austenitic-ferritic materials such as

2.4816	NiCr15Fe	UNS N06600
2.4817	LC- NiCr15Fe	UNS N10665
1.4876	X10 NiCrAlTi 32 20	UNS N08800
1.6907	X3 CrNiN 18 10	

Also used for joinings of high C content 25 / 35 CrNi cast steel to 1.4859 or 1.4876 for petrochemical installations with service temperatures up to 900 °C. Furthermore UTP A 068 HH can be used for repair welding of hardly weldable steels such as heat-treatable steels or tool steels. Additionally mixed joints of austenitic and ferritic materials with elevated service temperatures can be welded.

The welding deposit is hot-cracking-resistant and does not tend to embrittlement.

## Typical analysis in %

C	Si	Mn	Cr	Ni	Nb	Fe
< 0.02	< 0.2	3.0	20.0	balance	2.7	0.8

## Mechanical properties of the weld metal

Yield strength $R_{p0.2}$	Tensile strength $R_m$	Elongation A	Impact strength $K_V$
MPa	MPa	%	J (RT)      - 196 °C
> 380	> 640	> 35	160      80

## Welding instructions

Clean weld area thoroughly. Keep heat input as low as possible and interpass temperature at approx. 150 °C.

## Approvals

TÜV (No. 00882), KTA, ABS, DNV GL

## Form of delivery and recommended welding parameters

Wire diameter [mm]	Current type	Shielding gas (EN ISO 14175)		
0.8	DC (+)	I 1	I 3	Z-ArHeHC-30 / 2 / 0.05
1.0	DC (+)	I 1	I 3	Z-ArHeHC-30 / 2 / 0.05
1.2	DC (+)	I 1	I 3	Z-ArHeHC-30 / 2 / 0.05
1.6	DC (+)	I 1	I 3	Z-ArHeHC-30 / 2 / 0.05



## Classifications

solid wire

EN ISO 18274	AWS A5.14	Material-No.
S Ni 6059 (NiCr23Mo16)	ER NiCrMo-13	2.4607

## Characteristics and field of use

UTP A 759 is suitable for welding components in plants for chemical processes with highly corrosive media.

For joining materials of the same or similar natures, e.g.

2.4602	NiCr21Mo14W	UNS N06022
2.4605	NiCr23Mo16Al	UNS N06059
2.4610	NiMo16Cr16Ti	UNS N06455
2.4819	NiMo16Cr15W	UNS N10276

and these materials with low alloyed steels such as for surfacing on low alloyed steels.

Good corrosion resistance against acetic acid and acetic hydride, hot contaminated sulphuric and phosphoric acids and other contaminated oxidising mineral acids. Intermetallic precipitation will be largely avoided.

## Typical analysis in %

C	Si	Cr	Mo	Ni	Fe
< 0.01	0.1	22.5	15.5	balance	< 0.1

## Mechanical properties of the weld metal

Yield strength $R_{p0.2}$	Tensile strength $R_m$	Elongation $A$	Impact strength $K_V$
MPa	MPa	%	J (RT)
> 450	> 720	> 35	> 100

## Welding instructions

Welding instructions The welding area has to be free from impurities (oil, paint, grease and dust). Minimize heat input. The interpass temperature should not exceed 150 °C. Heat input < 12 kJ / cm.

## Approvals

TÜV (No. 06065), GL

## Form of delivery and recommended welding parameters

Wire diameter [mm]	Current type	Shielding gas (EN ISO 14175)
0.8*	DC (+)	Z-ArHeHC-30 / 2 / 0.05
1.0	DC (+)	Z-ArHeHC-30 / 2 / 0.05
1.2	DC (+)	Z-ArHeHC-30 / 2 / 0.05
1.6*	DC (+)	Z-ArHeHC-30 / 2 / 0.05

\*available on request

## UTP A 776

### Classifications

Wire for highly corrosion-resistant NiCrMo alloys

EN ISO 18274

AWS A5.14

Material-No.

S Ni 6276 (NiCr15Mo16Fe6W4)

ER NiCrMo-4

2.4886

### Characteristics and field of use

UTP A 776 is suitable for joint welding of matching base materials, such as 2.4819 NiMo16Cr15W UNS N10276 and claddings on low-alloyed steels.

UTP A 776 is primarily used for welding components in chemical plants with highly corrosive media, but also for surfacing press tools or punches which operate at high temperatures.

Excellent resistance against sulphuric acids and high chloride concentrations.

### Typical analysis in %

C	Si	Cr	Mo	Ni	V	W	Fe
< 0.01	0.07	16.0	16.0	balance	0.2	3.5	6.0

### Mechanical properties of the weld metal

Yield strength $R_{p0.2}$	Tensile strength $R_m$	Elongation $A$	Impact strength $K_v$
MPa	MPa	%	J [RT]
> 450	> 750	> 30	> 90

### Welding instructions

To avoid intermetallic precipitations, weld with lowest possible heat input and interpass temperature.

### Approvals

TÜV (No. 05586)

### Form of delivery and recommended welding parameters

Rod diameter x length [mm]	Current type	Shielding gas (EN ISO 14175)
1.2	DC (+)	Z-ArHeHC-30/2/0.05   1

# UTP A 786

## Classifications

solid wire

EN ISO 18274

AWS A5.14

S Ni 6686 (NiCr21Mo16W4)

ER NiCrMo-14

## Characteristics and field of use

UTP A 786 is suitable for joining and surfacing of high corrosion resistant NiCrMo alloys for chemical processes in highly corrosive reducing and oxidizing environments.

UTP A 786 is particularly designed for claddings of desulphurization and waste incineration components such as pipes and finned tubes made of heat resistant steels.

Joining of similar or dissimilar base materials:

Nickel base alloys

2.4602 NiCr21Mo14W

2.4605 NiCr23Mo16Al

2.4606 NiCr21Mo16W

2.4610 NiMo16Cr16Ti

2.4819 NiMo16Cr15W

Low alloyed steels

16Mo3, ASTM A 312 Gr. T11 / T12

## Typical analysis in %

C	Si	Mn	Cr	Mo	W	Al	Fe	Ni
0.01	0.08	< 0.5	22.8	16.0	3.8	0.3	< 1.0	balance

## Mechanical properties of the weld metal

Yield strength $R_{p0.2}$	Tensile strength $R_m$	Elongation $A$	Impact strength $K_V$
MPa	MPa	%	J [RT]
> 450	> 760	> 30	> 50

## Welding instructions

Clean the welding area thoroughly. Preheating of large parts at approx. 80 °C, interpass temperature max. 150 °C. Use MIG pulse welding process with a low heat input (< 10 kJ / cm).

## Form of delivery and recommended welding parameters

Wire diameter [mm]	Current type	Shielding gas (EN ISO 14175)
1.0	DC (+)	Z-ArHeH2Co2-30 / 2 / 0.05
1.2	DC (+)	Z-ArHeH2Co2-30 / 2 / 0.05

**UTP A 2133 Mn**

nickel alloys

**Classifications**

solid wire

EN ISO 14343

Material-No.

GZ 21 33 Mn Nb

~ 1.4850

**Characteristics and field of use**

UTP A 2133 Mn is suitable for joining and surfacing heat resistant base materials of identical and of similar nature, such as

1.4859	G X 10 NiCrNb 32 20
1.4876	X 10 NiCrAlTi 32 21 UNS N08800
1.4958	X 5 NiCrAlTi 31 20 UNS N08810
1.4959	X 8 NiCrAlTi 31 21 UNS N08811

A typical application is the root welding of centrifugally cast pipes in the petrochemical industry for operation temperatures up to 1050 °C in dependence with the atmosphere.

Scale resistant up to 1050 °C. Good resistance to carburising atmosphere.

**Typical analysis in %**

C	Si	Mn	Cr	Ni	Nb	Fe
0.12	0.3	4.5	21.0	33.0	1.2	balance

**Mechanical properties of the weld metal**

Yield strength $R_{p0.2}$	Tensile strength $R_m$	Elongation $A$	Impact strength $K_v$
MPa	MPa	%	J (RT)
400	600	20	70

**Form of delivery and recommended welding parameters**

Wire diameter [mm]	Current type	Shielding gas (EN ISO 14175)
0.8	DC (+)	I 1
1.0	DC (+)	I 1
1.2	DC (+)	I 1

## Classifications

solid wire

EN ISO 14343

Material-No.

GZ 25 35 Zr

1.4853

## Characteristics and field of use

UTP A 2535 Nb is suitable for joinings and building up on identical and similar high heat resistant CrNi cast steel (centrifugal- and mould cast parts), such as

1.4848	G – X 40 CrNiSi 25 20
1.4852	G – X 40 NiCrSiNb 35 25
1.4857	G – X 40 NiCrSi 35 25

The weld deposit is applicable in a low sulphur, carbon enriching atmosphere up to 1150 °C, such as reformer ovens in petrochemical installations.

## Typical analysis in %

C	Si	Mn	Cr	Ni	Nb	Ti	Zr	Fe
0.4	1.0	1.7	25.5	35.5	1.2	+	+	balance

## Mechanical properties of the weld metal

Yield strength $R_{p0.2}$	Tensile strength $R_m$	Elongation A
MPa	MPa	%
> 480	> 680	> 8

## Welding instructions

Clean welding area carefully. No pre-heating or post weld heat treatment. Keep heat input as low as possible and interpass temperature at max. 150 °C.

## Form of delivery and recommended welding parameters

Wire diameter [mm]	Current type	Shielding gas (EN ISO 14175)
1.0	DC (+)	I 1
1.2	DC (+)	I 1

**UTP A 3545 Nb**

nickel alloys

**Classifications**

TIG rod

EN ISO 18274

S Ni Z (NiCr36Fe15Nb0.8)

**Characteristics and field of use**

UTP A 3545 Nb is suitable for joining and surfacing on identical and similar high-heat-resistant cast alloys (centrifugal- and mould cast parts), such as GX-45NiCrNbSiTi45 35. The main application field is tubes and cast parts of reformer and pyrolysis ovens.

The weld deposit is applicable in low-sulphur, carbon-enriching atmosphere up to 1,175 °C. It yields excellent creep strength and a good resistance against carburization and oxidation.

**Typical analysis in %**

C	Si	Mn	Cr	Ni	Nb	Ti	Zr	Fe
0.45	1.5	0.8	35.0	45.0	0.8	0.1	0.05	balance

**Mechanical properties of the weld metal***Yield strength  $R_{p0.2}$* *Tensile strength  $R_m$* *MPa**MPa*

450

650

**Welding instructions**

Clean weld area thoroughly. No pre-heating or post weld heat treatment required. Keep heat input as low as possible and interpass temperature of max. 150 °C.

**Form of delivery and recommended welding parameters**

<i>Wire diameter [mm]</i>	<i>Current type</i>	<i>Shielding gas (EN ISO 14175)</i>
2.0 x 1000	DC (-)	I 1
2.4 x 1000	DC (-)	I 1
3.2 x 1000	DC (-)	I 1

# UTP A 4221

## Classifications

TIG rod

EN ISO 18274

AWS A5.14

S Ni 8065 (NiFe30Cr21Mo3)

ER NiFeCr-1 (UNS N08065)

## Characteristics and field of use

UTP A 4221 is suitable for joining and surfacing of alloys of similar nature, furthermore for welding of CrNi-MoCu-alloyed austenitic steels used for high quality tank and apparatus construction in the chemical industry, corrosion resistance in media of sulphuric and phosphoric acid.

UTP A 4221 is specially designed for welding alloy 825 (2.4858, UNS N08825).

Fully austenitic weld metal with high resistance against stress corrosion cracking and pitting in media containing chloride ions. Good corrosion resistance against reducing acids due to the combination of Ni, Mo and Cu. Sufficient resistance against oxidizing acids. The weld metal is corrosion resistant in sea water.

## Typical analysis in %

C	Si	Mn	Cr	Ni	Mo	Cu	Fe
0.01	0.25	0.8	20.5	41.0	3.1	1.8	balance

## Mechanical properties of the weld metal

<i>Yield strength <math>R_{p0.2}</math></i>	<i>Tensile strength <math>R_m</math></i>	<i>Elongation A</i>	<i>Impact strength <math>K_V</math></i>
<i>MPa</i>	<i>MPa</i>	<i>%</i>	<i>J [RT]</i>
360	> 550	> 30	> 100

## Welding instructions

The welding area has to be free from impurities (oil, paint, markings). Minimize heat input. The interpass temperature should not exceed 120°C.

## Form of delivery and recommended welding parameters

<i>Rod diameter x length [mm]</i>	<i>Current type</i>	<i>Shielding gas (EN ISO 14175)</i>
1.2 x 1000	DC (-)	I 1

## Classifications

solid wire

EN ISO 18274	AWS A5.14	Material-No.
S Ni 6625 (NiCr22Mo9Nb)	ER NiCrMo-3	2.4831

## Characteristics and field of use

UTP A 6222 Mo has a high nickel content and is suitable for welding high-strength and high-corrosion resistant nickel-base alloys, e.g.

X1	NiCrMoCuN25206	1.4529	UNS N08926
X1	NiCrMoCuN25205	1.4539	UNS N08904
	NiCr21Mo	2.4858	UNS N08825
	NiCr22Mo9Nb	2.4856	UNS N06625

It can be used for joining ferritic steel to austenitic steel as well as for surfacing on steel. It is also possible to weld 9 % nickel steels using this wire due to its high yield strength. Its wide range of uses is of particular significance in aviation, in chemical industry and in applications involving seawater.

The special features of the weld metal of UTP A 6222 Mo include a good creep rupture strength, corrosion resistance, resistance to stress and hot cracking. It is highly resistant and tough even at working temperatures up to 1100 °C. It has an extremely good fatigue resistance due to the alloying elements Mo and Nb in the NiCr-matrix. The weld metal is highly resistant to oxidation and is almost immune to stress corrosion cracking. It resists intergranular penetration without having been heat-treated.

## Typical analysis in %

C	Si	Cr	Mo	Ni	Nb	Fe
< 0.02	< 0.2	22.0	9.0	balance	3.5	1.0

## Mechanical properties of the weld metal

Yield strength $R_{p0.2}$	Tensile strength $R_m$	Elongation A	Impact strength $K_V$	
MPa	MPa	%	J (RT)	- 196 °C
> 460	> 740	> 30	> 100	> 85

## Welding instructions

The welding area has to be free from impurities (oil, paint, grease and dust). Minimize heat input. The interpass temperature should not exceed 150 °C. Heat input < 12 kJ / cm.

## Approvals

TÜV (No. 03460), DNV GL, ABS

## Form of delivery and recommended welding parameters

Wire diameter [mm]	Current type	Shielding gas (EN ISO 14175)	
0.8*	DC (+)	I 1	Z-ArHeHC-30 / 2 / 0.05
1.0	DC (+)	I 1	Z-ArHeHC-30 / 2 / 0.05
1.2	DC (+)	I 1	Z-ArHeHC-30 / 2 / 0.05
1.6	DC (+)	I 1	Z-ArHeHC-30 / 2 / 0.05

\*available on request



# UTP A 6222 Mo-3

## Classifications

solid wire

EN ISO 18274

AWS A5.14

Material-No.

S Ni 6625 (NiCr22Mo9Nb)

ER NiCrMo-3

2.4831

## Characteristics and field of use

UTP A 6222 Mo-3 has been developed for applications in the oil & gas industry, and is mainly used for cladding and joining of unalloyed and high strength low alloyed steel (HSLA) components. Typical applications are internal cladding of tubes & pipes, risers, and subsea components such as manifolds, BOPs, Christmas trees, well heads, flanges, valve bodies, blocks etc. to improve corrosion resistance to surfaces exposed to hydrocarbon and hydrogen sulphide.

Typical base metals for these applications are SAE 4130, SAE 8630, F 22, F 65. UTP A 6222 Mo-3 has excellent dissimilar materials welding characteristics and can be used for joining components produced from a variety of clad and base metal alloys such as austenitic, super austenitic, martensitic, Duplex and Super Duplex stainless steels.

UTP A 6222 Mo-3 is manufactured to optimise wire-feed and weld pool delivery characteristics, via consistent metallurgical quality raw material and physical control of wire processing, pre-requisites for successful cold and hot wire GTAW / TIG applications where the highest quality standards have to be fulfilled. The wire can also be successfully applied using the GMAW / MIG process.

UTP A 6222 Mo-3 can be welded with either cold- or hot wire automated TIG (GTAW) or MIG (GMAW) processes.

## Typical analysis in %

C	Si	Cr	Mo	Nb	Fe	Ni
≤ 0.02	≤ 0.2	22.0	9.0	3.5	<1.0	balance

## Form of delivery and recommended welding parameters

Wire diameter [mm]	Current type		Shielding gas (EN ISO 14175)		
	TIG	MIG			
0.9	DC (-)	DC (+)	I 1	Z-ArHeHC-30 / 2 / 0.5	
1.0	DC (-)	DC (+)	I 1	Z-ArHeHC-30 / 2 / 0.5	
1.14	DC (-)	DC (+)	I 1	Z-ArHeHC-30 / 2 / 0.5	
1.2	DC (-)	DC (+)	I 1	Z-ArHeHC-30 / 2 / 0.5	
1.6	DC (-)	DC (+)	I 1	Z-ArHeHC-30 / 2 / 0.5	

**Classifications**

solid wire

EN ISO 18274	AWS A5.14	Material-No.
S Ni 6025 (NiCr25Fe10AlY)	ER NiCrFe-12	2.4649

**Characteristics and field of use**

UTP A 6225 Al is suitable for welding of identical and similar alloys, such as NiCr25FeAlY, Material-No. 2.4633. These alloys are applicable for working temperatures up to 1200 °C, particularly for thermal treatment ovens.

High oxidation resistance at high temperatures (also in cyclic conditions), very good corrosion resistance in carburized medias, excellent high temperature resistance.

**Typical analysis in %**

C	Si	Mn	Cr	Ni	Ti	Zr	Al	Fe	Y
0.2	0.5	0.1	25.0	balance	0.15	0.05	2.0	10.0	0.08

**Mechanical properties of the weld metal**

<i>Yield strength <math>R_{p0.2}</math></i>	<i>Tensile strength <math>R_m</math></i>	<i>Elongation A</i>	<i>Impact strength <math>K_v</math></i>
<i>MPa</i>	<i>MPa</i>	<i>%</i>	<i>J (RT)</i>
500	720	25	50

**Welding instructions**

Clean the weld area thoroughly (free of oil, scale, markings). Use stringer bead technique. Keep heat input as low as possible and interpass temperature at max. 150 °C. UTP A 6225 Al should only be welded by using the below recommended gas.

**Approvals**

TÜV (No. 10135)

**Form of delivery and recommended welding parameters**

<i>Wire diameter [mm]</i>	<i>Current type</i>	<i>Shielding gas (EN ISO 14175)</i>
1.2	DC (+)	Z-ArHeNC-5 / 5 / 0.05

## Classifications

solid wire

Special alloy

## Characteristics and field of use

UTP A 8036 S is an alloy of the same composition as the base material and used for welding cast alloys with a nickel content of 34 – 40 % (INVAR qualities). The special operational area is the structural welding of housings made of plate and cast pieces with a nickel content of 36 %. Application field: air plane construction.

The weld metal contains high mechanical properties and a very low expansion coefficient.

## Typical analysis in %

C	Si	Mn	P	S	Ni	Fe
0.015-0.025	0.1	0.3	< 0.01	< 0.01	34.0-38.0	balance

## Mechanical properties of the weld metal

Yield strength $R_{p0.2}$	Tensile strength $R_m$	Elongation $A$	Impact strength $K_v$	Hardness
MPa	MPa	%	J (RT)	HB
> 280	> 350	> 25	> 80	appr. 150

## Welding instructions

Thorough cleaning of welding area is essential. Welding parameters need to be adjusted to each individual application. Pay attention to a low heat input. The weld should be performed by applying a pulsed arc technique.

## Form of delivery and recommended welding parameters

Wire diameter [mm]	Current type	Shielding gas (EN ISO 14175)
1.2	DC (+)	M 12

## Solid wires for repair of cracked material

### 4. Cast iron

Product name	EN ISO		Page
UTP A 8051 Ti	1071	S C NiFe-2	179

#### Solution example

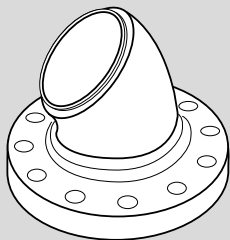

*Flange*

UTP A 8051 Ti

## UTP A 8051 Ti

cast iron

### Classifications

solid wire

EN ISO 1071

S C NiFe-2

### Characteristics and field of use

UTP A 8051 Ti is particularly suited for MIG / MAG welding of ferritic and austenitic nodular cast iron as well as for joining it with unalloyed and high-alloyed steels, copper and nickel alloys. Build-up layers on grey cast iron qualities are also possible. Special applications are construction welding of ductile centrifugal casting tubes, such as joggles and flange joints, fittings, pumps.

The deposit is tough, crack resistant and easily machinable with cutting tools.

### Typical analysis in %

C	Mn	Ni	Ti	Fe
0.1	3.5	55.0	0.5	balance

### Mechanical properties of the weld metal

Yield strength $R_e$	Tensile strength $R_m$	Elongation $A_5$	Hardness
MPa	MPa	%	HB
> 300	> 500	> 25	approx. 200

### Welding instructions

Welding area shall be metallic bright. UTP A 8051 Ti is usually welded by the cold-welding technique, keeping heat input < 12 kJ / cm and interpass temperature < 120 °C. Massive cast iron pieces to ~150 – 200 °C, depending on their geometry. Weld preferably with MIG-pulsed arc, in order to reduce the dilution with the base metal.

### Form of delivery and recommended welding parameters

Wire diameter [mm]	Current type	Shielding gas (EN ISO 14175)
0.8	DC (+)	M 12
1.0	DC (+)	M 12
1.2	DC (+)	M 12

## Solid wires for repair of cracked material

### 5. Copper alloys

Product name	EN ISO		AWS		Mat.-No.	Page
UTP A 34	24373	S Cu 6100	A5.7	ER CuAl-A 1	2.0921	181
UTP A 34 N	24373	S Cu 6338	A5.7	ER CuMnNiAl	2.1367	182
UTP A 38	24373	S Cu 1897	A5.7	ER Cu	2.1211	183
UTP A 381	24373	S Cu 1898	A5.7	ER Cu	2.1006	184
UTP A 384	24373	S Cu 6560	A5.7	ER CuSi-A	2.1461	185
UTP A 387	24373	S Cu 7158	A5.7	ER CuNi	2.0837	186
UTP A 3422	24373	S Cu 6327			2.0922	187
UTP A 3444	24373	S Cu 6328	A5.7	ER CUNiAl	2.0923	188

#### Solution examples

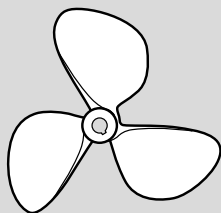

*Ship propeller*

UTP A 34 N

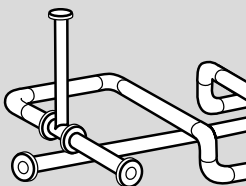

*Piping*

UTP A 38

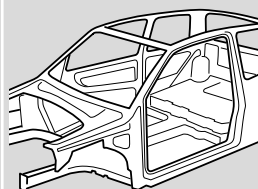

*Body work*

UTP A 384

# UTP A 34

copper alloys

## Classifications

solid wire

EN ISO 24373	AWS A5.7	Material-No.
S Cu 6100 (CuAl7)	ER CuAl-A 1	2.0921

## Characteristics and field of use

UTP A 34 is used for copper aluminium alloys (aluminium bronzes) with 5 – 9 % Al, copper-zinc alloys (brass and special brass). Weld cladding on cast iron materials and steel.

The weld deposit of UTP A 34 is resistant to corrosion and seawater and has good gliding properties metal-metal. UTP A 34 is easy weldable and obtains a clean weld surface.

## Typical analysis in %

Mn	Ni	Cu	Al	Fe
< 0.5	< 0.5	balance	8.0	< 0.5

## Mechanical properties of the weld metal

Yield strength $R_{p0.2}$	Tensile strength $R_m$	Elongation $A_5$	Hardness	El. conductivity	Melting range
MPa	MPa	%	HB	s.m / mm <sup>2</sup>	°C
180	400	40	120	8	1030 – 1040

## Welding instructions

The weld seam area has to be machined to a metallic bright by grinding, sand blasting or pickling in order to avoid crack formation or the development of pores.

## Approvals

GL

## Form of delivery and recommended welding parameters

Wire diameter [mm]	Current type	Shielding gas (EN ISO 14175)
0.8*	DC (+)	I 1
1.0	DC (+)	I 1
1.2	DC (+)	I 1
1.6	DC (+)	I 1

\*available on request

**UTP A 34 N**

copper alloys

**Classifications**

solid wire

EN ISO 24373	AWS A5.7	Material-No.
S Cu 6338 (CuMn13Al8Fe3Ni2)	ER CuMnNiAl	2.1367

**Characteristics and field of use**

UTP A 34 N is applied in MIG joining and surfacing on complex aluminium bronzes mainly on such materials with a high Mn content as well as on steel and cast steel by using a nodular iron rod. Because of the excellent resistance to seawater and general corrosion resistance, the alloy is excellently suited in the shipbuilding industry (propellers, pumps and armatures) and in the chemical industry (valves, slides, pumps) and is mainly for applications subjected to chemical attacks combined with erosion. Because of the good friction coefficient it is suited for surfacing on waves, gliding surfaces, bearing and matrix of all sorts.

UTP A 34 N is very good weldable in the MIG pulsing method. The weld deposit has excellent mechanical properties and is tough and crack resistant. Very good chip removal machining, corrosion resistant and non magnetic.

**Typical analysis in %**

Mn	Ni	Cu	Al	Fe
13.0	2.5	balance	7.5	2.5

**Mechanical properties of the weld metal**

<i>Yield strength <math>R_{p0.2}</math></i>	<i>Tensile strength <math>R_m</math></i>	<i>Elongation <math>A_5</math></i>	<i>Hardness</i>	<i>El. conductivity</i>	<i>Melting range</i>
<i>MPa</i>	<i>MPa</i>	<i>%</i>	<i>HB</i>	<i>s·m / mm<sup>2</sup></i>	<i>°C</i>
400	650	15	220	3-5	945 – 985

**Welding instructions**

Clean weld area thoroughly (metallic bright). Preheating temperature of large weldments to approx. 150 °C. Heat-input should be kept low and the interpass temperature should not exceed 150 °C.

**Form of delivery and recommended welding parameters**

<i>Wire diameter [mm]</i>	<i>Current type</i>	<i>Shielding gas (EN ISO 14175)</i>
1.0	DC (+)	I 1
1.2	DC (+)	I 1
1.6	DC (+)	I 1



## Classifications

solid wire

EN ISO 24373	AWS A5.7	Material-No.
S Cu 1897 (CuAg1)	ER Cu	2.1211

## Characteristics and field of use

UTP A 38 is used for oxygen free copper types according to DIN 1787 OF-Cu, SE-Cu, SW-Cu, SF-Cu. The main applications are in the electrical industry e.g. for conductor rails or other applications where high electricity is required.

Viscous weld puddle, fine grained structure, high electrical conductivity.

## Typical analysis in %

Mn	Ni	Cu	Ag
< 0.2	< 0.3	balance	1.0

## Mechanical properties of the weld metal

Yield strength $R_{p0.2}$	Tensile strength $R_m$	Elongation $A_5$	Hardness	El. conductivity	Melting range
MPa	MPa	%	HB	s.m / mm <sup>2</sup>	°C
80	200	20	60	30 – 45	1070 – 1080

## Welding instructions

Clean welding area thoroughly. For wall thickness of > 3 mm a preheating is necessary (max 600 °C).

## Form of delivery and recommended welding parameters

Wire diameter [mm]	Current type	Shielding gas (EN ISO 14175)	
1.0*	DC (+)	I 1	I 3
1.2*	DC (+)	I 1	I 3
1.6*	DC (+)	I 1	I 3

\*available on request

**Classifications**

solid wire

EN ISO 24373	AWS A5.7	Material-No.
S Cu 1898 (CuSn1)	ER Cu	2.1006

**Characteristics and field of use**

UTP A 381 is used for oxygen free copper types according to DIN 1787 OF-Cu, SE-Cu, SW-Cu, SF-Cu. The main applicational fields are in the apparatus- and pipeline construction.

Fluid weld pool.

**Typical analysis in %**

Si	Mn	Ni	Cu	Sn
0.3	0.25	< 0.3	balance	0.8

**Mechanical properties of the weld metal**

<i>Yield strength <math>R_{p0.2}</math></i>	<i>Tensile strength <math>R_m</math></i>	<i>Elongation <math>A_5</math></i>	<i>Hardness</i>	<i>El. conductivity</i>	<i>Melting range</i>
<i>MPa</i>	<i>MPa</i>	<i>%</i>	<i>HB</i>	<i>s-m / mm<sup>2</sup></i>	<i>°C</i>
50	200	30	approx. 60	15 – 20	1020 – 1050

**Welding instructions**

Clean weld area thoroughly. For each application field the parameters must be optimized. In a wall thickness > 3 mm, preheating to maximal 600 °C is necessary.

**Form of delivery and recommended welding parameters**

<i>Wire diameter [mm]</i>	<i>Current type</i>	<i>Shielding gas (EN ISO 14175)</i>	
1.0*	DC (+)	I 1	I 3
1.2	DC (+)	I 1	I 3
1.6	DC (+)	I 1	I 3

\*available on request

## Classifications

solid wire

EN ISO 24373	AWS A5.7	Material-No.
S Cu 6560 (CuSi3Mn1)	ER CuSi-A	2.1461

## Characteristics and field of use

UTP A 384 is especially suited for joints of coated steel plates according to the MIG welding for repair welding of motor vehicle bodies and plate constructions of all sorts. The alloy is also especially suited for hot galvanized and hot dip galvanized plates. Same joints on copper-silicon and copper-manganese alloys according to DIN 1766, as for example CuSi2Mn, CuSi3Mn, CuMn5, brass and red brass (tombac).

The low hardness of UTP A 384 allows a relatively easy machining of the visible weld seam in comparison to the iron base weld metal.

## Typical analysis in %

Si	Mn	Cu	Sn	Fe
3.0	1.0	balance	< 0.2	< 0.3

## Mechanical properties of the weld metal

Yield strength $R_{p0.2}$	Tensile strength $R_m$	Elongation $A_5$	Hardness	El. conductivity	Melting range
MPa	MPa	%	HB	s.m / mm <sup>2</sup>	°C
120	350	40	80	3 – 4	965 – 1035

## Welding instructions

Clean weld area thoroughly. Welding parameters have to be optimised for each usage. Pay attention to a low heat input. (short arc / MIG pulsed arc)

## Form of delivery and recommended welding parameters

Wire diameter [mm]	Current type	Shielding gas (EN ISO 14175)	
0.8*	DC (+)	I 1	I 3
1.0	DC (+)	I 1	I 3
1.2	DC (+)	I 1	I 3
1.6*	DC (+)	I 1	I 3

\*available on request

## Classifications

solid wire

EN ISO 24373	AWS A5.7	Material-No.
S Cu 7158 (CuNi30Mn1FeTi)	ER CuNi	2.0837

## Characteristics and field of use

UTP A 387 is used for copper nickel alloys with up to 30 % nickel according to DIN 17664, such as CuNi20Fe (2.0878), CuNi30Fe (2.0882). Chemical industry, seawater desalination plants, ship building, offshore technique.

The weld metal of UTP A 387 is resistant to seawater and cavitation.

## Typical analysis in %

C	Mn	Ni	Cu	Ti	Fe
< 0.05	0.8	30.0	balance	< 0.5	0.6

## Mechanical properties of the weld metal

Yield strength $R_{p0.2}$	Tensile strength $R_m$	Elongation $A_5$	Hardness	El. conductivity	Melting range
MPa	MPa	%	HB	s-m / mm <sup>2</sup>	°C
> 200	> 360	> 30	120	3	1180 – 1240

## Welding instructions

V-butt weld with 70 ° included angle and root gap of 2 mm. Remove oxide skin to approx. 10 mm to the joint groove also on the backside of the weld.

## Approvals

TÜV (No. 01624), GL

## Form of delivery and recommended welding parameters

Wire diameter [mm]	Current type	Shielding gas (EN ISO 14175)	
0.8*	DC (+)	I 1	I 3
1.0*	DC (+)	I 1	I 3
1.2	DC (+)	I 1	I 3
1.6*	DC (+)	I 1	I 3

\*available on request

**Classifications**

solid wire

EN ISO 24373

Material-No.

S Cu 6327 (CuAl8Ni2Fe2Mn2)

2.0922

**Characteristics and field of use**

UTP A 3422 is used for copper-aluminium alloys with Ni and Fe addition. Weld cladding on cast iron materials and steel. Mixed joints of aluminium bronze steel. It is resistant to seawater, and cavitation resistant.

The weld metal of UTP A 3422 is resistant to seawater and cavitation. Good suitability for simultaneous stress strain caused by seawater, cavitation and erosion.

**Typical analysis in %**

Mn	Ni	Cu	Al	Fe
1.8	2.5	balance	8.5	1.5

**Mechanical properties of the weld metal**

<i>Yield strength <math>R_{p0.2}</math></i>	<i>Tensile strength <math>R_m</math></i>	<i>Elongation <math>A_5</math></i>	<i>Hardness</i>	<i>El. conductivity</i>	<i>Melting range</i>
<i>MPa</i>	<i>MPa</i>	<i>%</i>	<i>HB</i>	<i>s.m / mm<sup>2</sup></i>	<i>°C</i>
300	650	25	160	5	1030 – 1050

**Welding instructions**

The weld seam area has to be machined to a metallic bright by grinding, sand blasting or pickling in order to avoid crack formation or the development of pores.

**Approvals**

GL

**Form of delivery and recommended welding parameters**

<i>Wire diameter [mm]</i>	<i>Current type</i>	<i>Shielding gas (EN ISO 14175)</i>
1.0	DC (+)	I 1
1.2	DC (+)	I 1
1.6	DC (+)	I 1

## Classifications

solid wire

EN ISO 24373	AWS A5.7	Material-No.
S Cu 6328 (CuAl9Ni5Fe3Mn2)	ER CuNiAl	2.0923

## Characteristics and field of use

UTP A 3444 is a copper aluminium multi bronzes with a high Ni and Fe addition. Weld cladding on cast iron materials and steel. Mixed joints with aluminium bronze steel. It is resistant to seawater and cavitation resistant.

The weld metal of UTP A 3444 is resistant to seawater and cavitation. Good suitability for simultaneous stress strain caused by seawater, cavitation and erosion.

## Typical analysis in %

Mn	Ni	Cu	Al	Fe
1.0	4.5	balance	9.0	3.5

## Mechanical properties of the weld metal

<i>Yield strength <math>R_{p0.2}</math></i>	<i>Tensile strength <math>R_m</math></i>	<i>Elongation <math>A_5</math></i>	<i>Hardness</i>	<i>El. conductivity</i>	<i>Melting range</i>
<i>MPa</i>	<i>MPa</i>	<i>%</i>	<i>HB</i>	<i>s-m / mm<sup>2</sup></i>	<i>°C</i>
400	700	15	200	4	1015 – 1045

## Welding instructions

The weld seam area has to be machined to a metallic bright by grinding, sand blasting or pickling in order to avoid crack formation or the development of pores.

## Form of delivery and recommended welding parameters

<i>Wire diameter [mm]</i>	<i>Current type</i>	<i>Shielding gas (EN ISO 14175)</i>
1.0	DC (+)	I 1
1.2	DC (+)	I 1
1.6	DC (+)	I 1



## Surfacing solid wires for anti-wear and anti-corrosion applications

Product name	EN ISO		AWS	
UTP A 34 N	24373	S Cu 6338	A5.7	ER CuMnNiAl
UTP A 73 G 2	14700	S Fe8		
UTP A 73 G 3	14700	S Z Fe3		
UTP A 73 G 4	14700	S Z Fe3		
UTP A 661	14343-A	GZ 17 Mo H		
UTP A 702	14700	S Z Fe5		
UTP A 5519 Co	14700	S Ni2		
UTP A 6170 Co	18274	S Ni 6617	A5.14	ER NiCrCoMo-1
UTP A DUR 250	14700	S Z Fe1		
UTP A DUR 350	14700	S Z Fe2		
UTP A DUR 600	14700	S Fe8		
UTP A DUR 650	14700	S Fe8		

### Solution examples

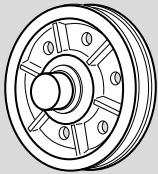
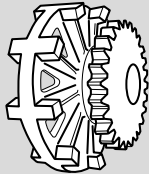
	
<i>Crane wheel</i>	<i>Drive tumbler</i>
UTP A DUR 250	UTP A DUR 350



Mat. - No.	Type of wear								Page
	Abrasion	Corrosion	Erosion	Cavitation	Heat	Impact	Metal to Earth	Metal to Metal	
2.1367		■		■				■	192
Special alloy	■		■		■	■		■	193
Special alloy	■		■		■	■		■	194
Special alloy	■		■		■	■		■	195
1.4115		■			■	■		■	196
1.6356					■	■		■	197
									198
2.4627		■			■	■		■	199
1.8401								■	200
1.8405						■		■	201
1.4718	■		■			■	■	■	202
	■		■		■	■	■	■	203

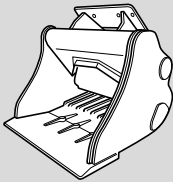

Excavator bucket

UTP A DUR 600

**UTP A 34 N**

anti-wear &amp; anti-corrosion

**Classifications**

solid wire

EN ISO 24373

AWS A5.7

Material-No.

S Cu 6338 (CuMn13Al8Fe3Ni2)

ER CuMnNiAl

2.1367

**Characteristics and field of use**

UTP A 34 N is applied in MIG joining and surfacing on complex aluminium bronzes mainly on such materials with a high Mn content as well as on steel and cast steel by using a nodular iron rod. Because of the excellent resistance to seawater and general corrosion resistance, the alloy is excellently suited in the shipbuilding industry (propellers, pumps and armatures) and in the chemical industry (valves, slides, pumps) and is mainly for applications subjected to chemical attacks combined with erosion. Because of the good friction coefficient it is suited for surfacing on waves, gliding surfaces, bearing and matrix of all sorts.

UTP A 34 N is very good weldable in the MIG pulsing method. The weld deposit has excellent mechanical properties and is tough and crack resistant. Very good chip removal machining, corrosion resistant and non magnetic.

**Typical analysis in %**

Mn	Ni	Cu	Al	Fe
13.0	2.5	balance	7.5	2.5

**Mechanical properties of the weld metal**

Yield strength $R_{p0.2}$	Tensile strength $R_m$	Elongation $A_5$	Hardness	El. conductivity	Melting range
MPa	MPa	%	HB	s·m / mm <sup>2</sup>	°C
400	650	15	220	3 – 5	945 – 985

**Welding instructions**

Clean weld area thoroughly (metallic bright). Preheating temperature of large weldments to approx. 150 °C. Heat-input should be kept low and the interpass temperature should not exceed 150 °C.

**Form of delivery and recommended welding parameters**

Wire diameter [mm]	Current type	Shielding gas (EN ISO 14175)
1.0	DC (+)	I 1
1.2	DC (+)	I 1
1.6	DC (+)	I 1

## Classifications

solid wire

EN 14700	DIN 8555	Material-No.
S Fe8	MSG 3-GZ-55-ST	Special alloy

## Characteristics and field of use

UTP A 73 G 2 is used for highly wear resistant buildups on machine parts and tools, subject to heavy abrasion and compression combined with moderate impact at elevated temperatures, such as forging tools, roll mandrils, hot trimming knives, mangle and axial rolls as well as for the production of high-quality working surfaces by cladding non- or low-alloy base material.

Machinable by grinding or with tungstene carbide tools.

Hardness of the pure weld deposit:

untreated	53 – 58 HRC
soft-annealed 820 °C	approx. 200 HB
hardened 1050 °C / oil	approx. 58 HRC
tempered 600 °C	approx. 53 HRC
1 layer on non-alloyed steel	approx. 45 HRC

## Typical analysis in %

C	Si	Mn	Cr	Mo	Ti	Fe
0.35	0.3	1.2	7.0	2.0	0.3	balance

## Welding instructions

Clean welding area to metallic bright. Cracks in the base material have to be gouged out completely. Preheating temperature of 400 °C on tools should be maintained. Stress relief / annealing is recommended at 550 °C.

## Form of delivery and recommended welding parameters

Wire diameter [mm]	Current type	Shielding gas (EN ISO 14175)			
0.8*	DC (+)	M 12	M 13	M 21	C 1
1.0	DC (+)	M 12	M 13	M 21	C 1
1.2	DC (+)	M 12	M 13	M 21	C 1
1.6	DC (+)	M 12	M 13	M 21	C 1

This product is also available as TIG rod

\*available on request

**UTP A 73 G 3**

anti-wear

**Classifications**

solid wire

EN 14700	DIN 8555	Material-No.
S Z Fe3	MSG 3-GZ-45-T	Special alloy

**Characteristics and field of use**

UTP A 73 G 3 is, due to the excellent hot wear resistance and toughness, used for highly stressed hot working tools, which are simultaneously subject to high mechanical, thermal and abrasive loads, such as e.g. forging dies for hammers and presses, forging dies, Al-die cast moulds, plastic moulds, hot-shear blades and for filling engravings by using cheaper base metals.

Machining is possible with tungstene carbide tools.

Hardness of the pure weld deposit:

untreated	42 – 46 HRC
soft-annealed 780 °C	approx. 230 HB
hardened 1030 °C / oil	approx. 48 HRC
tempered 600 °C	approx. 45 HRC
1 layer on non-alloy steel	approx. 35 HRC

**Typical analysis in %**

C	Si	Mn	Cr	Mo	Ti	Fe
0.25	0.5	0.7	5.0	4.0	0.6	balance

**Welding instructions**

Machine welding area to metallic bright. Cracks in the base material have to be gouged out completely. Preheating temperature of 400 °C on tools should be maintained. Stress relief / annealing is recommended at 550 °C.

**Approvals**

TÜV (No. 06741)

**Form of delivery and recommended welding parameters**

Wire diameter [mm]	Current type	Shielding gas (EN ISO 14175)			
0.8	DC (+)	M 12	M 13	M 21	C 1
1.0	DC (+)	M 12	M 13	M 21	C 1
1.6	DC (+)	M 12	M 13	M 21	C 1

This product is also available as TIG rod

# UTP A 73 G 4

anti-wear

## Classifications

solid wire

EN 14700

DIN 8555

S Z Fe3

MSG 3-GZ-40-T

## Characteristics and field of use

UTP A 73 G 4 is, due to its excellent hot wear resistance and toughness, used for buildups on hot working tools and structural parts subject to impact, compression and abrasion at elevated temperatures, such as forging dies, die cast moulds, plastic moulds, guides, recipients, continuous casting rolls. Hot wear resistant claddings can be made on non-alloy or low-alloy base materials, such as e.g. boiler tubes in coal burning power stations. The deposit is machinable with cutting tools.

UTP A 73 G4 has very good welding properties, good weld buildup and an even flow of the weld pool.

Hardness of the pure weld deposit:

untreated	38 – 42 HRC
soft-annealed 800 °C	approx. 230 HB
hardened 1030 °C / oil	approx. 48 HRC
tempered 550 °C	approx. 42 HRC
1 layer on non-alloy steel	approx. 30 HRC

## Typical analysis in %

C	Si	Mn	Cr	Mo	Fe
0.1	0.4	0.6	6.5	3.3	balance

## Welding instructions

Machine welding area to metallic bright. Cracks in the base material have to be gouged out completely. Preheating temperature of 400 °C on tools should be maintained. Stress relief / annealing is recommended at 550 °C. Preheating on non- and low-alloy materials is generally not required.

## Approvals

TÜV (No. 06742)

## Form of delivery and recommended welding parameters

Wire diameter [mm]	Current type	Shielding gas (EN ISO 14175)			
1.0	DC (+)	M 12	M 13	M 21	C 1
1.2	DC (+)	M 12	M 13	M 21	C 1
1.6	DC (+)	M 12	M 13	M 21	C 1

This product is also available as TIG rod

**UTP A 661**

anti-wear

**Classifications**

solid wire

EN ISO 14343-A

EN 14700

Material-No.

G Z 17 Mo H

S Fe7

1.4115

**Characteristics and field of use**

UTP A 661 is used for wear resistant claddings on construction parts made of non-alloyed or low-alloyed steels and cast steels, hot working steels, high alloyed steels and cast steels, particularly for one-layer-welding. Special application fields are claddings on machine parts made of high tensile steel for hardening and tempering, hot working tools, continuous casting rolls and dummy blocks, membrane sides in coal burning power stations and parts resistant against high temperature up to 900 °C.

The martensitic weld deposit is wear resistant also at elevated temperatures. It is resistant against water, seawater, steam and diluted organic acids. High thermal strength.

Hardness of the pure weld deposit:

untreated

approx. 40 HRC

one-layer-welding on C 45

approx. 55 HRC

**Typical analysis in %**

C	Si	Mn	Cr	Mo	Fe
0.22	0.7	0.7	17.5	1.2	balance

**Welding instructions**

Welding with MIG pulsed current provides a low-in-spatter deposit of perfect appearance. The preheating must be matched to the parent metal and the welding scope, generally between 150 °C – 400 °C. Slow cooling in still air or under a cover resp. in an oven. Tempering, if necessary.

**Approvals**

TÜV (No. 06743)

**Form of delivery and recommended welding parameters**

Wire diameter [mm]	Current type	Shielding gas (EN ISO 14175)			
1.0*	DC (+)	M 12	M 13	M 21	C 1
1.2	DC (+)	M 12	M 13	M 21	C 1
1.6	DC (+)	M 12	M 13	M 21	C 1

\*available on request

**Classifications**

solid wire

EN 14700

DIN 8555

Material-No.

S Z Fe5

MSG 3-GZ-350-T

1.6356

**Characteristics and field of use**

UTP A 702 is used for repair, preventive maintenance and production of highly stressed cold and hot working tools, such as punching dies, cold and hot cutting knives, AI-die cast moulds, cold forging dies, drawing-, stamping- and chamfering tools. The weld deposit is, in as-welded condition, machinable, and the subsequent artificial aging optimises the resistance to hot wear and alternating temperatures.

The weld deposit of UTP A 702 has high strength and good toughness.

Hardness of the pure weld deposit:

untreated	32 – 35 HRC
hot-aged 3 – 4 h / 480 °C	50 – 54 HRC

**Typical analysis in %**

C	Mo	Ni	Co	Ti	Al	Fe
0.02	4.0	18.0	12.0	1.6	0.1	balance

**Welding instructions**

Machine welding area has to be metallic bright. Preheat massive pieces to 100 – 150 °C, on low-alloyed base metal apply min. 3 – 4 layer. Weld with lowest possible heat input.

**Form of delivery and recommended welding parameters**

Wire diameter [mm]	Current type	Shielding gas (EN ISO 14175)		
1.0*	DC (+)	M 12	M 13	I 1
1.2	DC (+)	M 12	M 13	I 1

\*available on request

**UTP A 5519 Co**

anti-wear

**Classifications**

solid wire

EN 14700

DIN 8555

S Ni2

MSG 23-GZ-250-CKTZ

**Characteristics and field of use**

UTP A 5519 Co is used for surfacings on forging tools which are subject to extreme thermal shock, compression, impact and abrasion, such as forging saddles, exposed areas on dies, hot-shearing blades and impact extrusion mandrels.

The special NiCrCoMoTiAl weld deposit is heat-resistant and resistant against oxidation, scale and thermal shocks. Age hardening increases the hardness of the weld overlay. Machining is possible with tungsten carbide tools.

Hardness of the pure weld deposit:

As welded: approx. 250 HB

After age-hardening

4 h at 850 °C + 16 h at 760 °C : approx. 380 HB

After work-hardening : approx. 400 HB

**Typical analysis in %**

C	Cr	Mo	Co	Ti	Al	Fe	Ni
0.03	20.0	4.5	14.0	3.0	1.5	< 2.0	balance

**Welding instructions**

Clean welding area to a bright metallic finish. Typical preheating temperature for hot work tool steels is between 300 – 400 °C. Minimise dilution by welding with low heat input. Stringer bead technique is recommended. For thick weld deposits on forging saddles, build-up should be done with UTP A 6222 Mo, final layers with UTP A 5519 Co.

**Form of delivery and recommended welding parameters**

Wire diameter [mm]	Current type	Shielding gas (EN ISO 14175)	
1.2	DC (+)	R 1	Z-ArHeHC-30/2/0.05



## Classifications

solid wire

EN ISO 18274	AWS A5.14	Material-No.
S Ni 6617 (NiCr22Co12Mo9)	ER NiCrCoMo-1	2.4627

## Characteristics and field of use

UTP A 6170 Co is particularly used for joining heat resistant and creep resistant nickel base alloys of identical and similar nature, high temperature austenitic and cast alloys, such as

1.4958	X5NiCrAlTi 31 20	UNS N08810
1.4959	X8NiCrAlTi 32 21	UNS N08811
2.4663	NiCr23Co12Mo	UNS N06617

The weld metal is resistant to hot-cracking. It is used for operating temperatures up to 1100 °C. Scale-resistant at temperatures up to 1100 °C in oxidizing resp. carburizing atmospheres, e.g. gas turbines, ethylene production plants.

## Typical analysis in %

C	Si	Cr	Mo	Ni	Co	Ti	Al	Fe
0.06	< 0.3	22.0	8.5	balance	11.5	0.4	1.0	1.0

## Mechanical properties of the weld metal

Yield strength $R_{p0.2}$	Tensile strength $R_m$	Elongation $A$	Impact strength $K_V$
MPa	MPa	%	J (RT)
> 450	> 750	> 30	> 120

## Welding instructions

Clean welding area carefully. Keep heat input as low as possible and interpass temperature at max. 150 °C.

## Approvals

TÜV (No. 05450)

## Form of delivery and recommended welding parameters

Wire diameter [mm]	Current type	Shielding gas (EN ISO 14175)	
0.8	DC (+)	I 1	Z-ArHeHC-30 / 2 / 0.05
1.0	DC (+)	I 1	Z-ArHeHC-30 / 2 / 0.05
1.2	DC (+)	I 1	Z-ArHeHC-30 / 2 / 0.05
1.6	DC (+)	I 1	Z-ArHeHC-30 / 2 / 0.05

**UTP A DUR 250**

anti-wear

**Classifications**

solid wire

EN 14700	DIN 8555	Material-No.
SZ Fe 1	MSG 1-GZ-250	1.8401

**Characteristics and field of use**

UTP A DUR 250 is used for MAG buildups on structural parts subject to rolling wear and where a good machinability is required, such as rails and rail crossings, crane wheels, rollers, couplings, shafts and gear parts.

UTP A DUR 250 has a very good resistance against compression and rolling strain. The weld metal is easily machinable.

Hardness of the pure weld deposit: approx. 250 HB

**Typical analysis in %**

C	Si	Mn	Cr	Ti	Fe
0.3	0.5	1.0	1.0	0.2	balance

**Welding instructions**

Machine welding area has to be metallic bright. Massive parts have to be preheated to 300°C.

**Form of delivery and recommended welding parameters**

Wire diameter [mm]	Current type	Shielding gas (EN ISO 14175)		
1.2	DC (+)	M 12	M 13	M 21
1.6*	DC (+)	M 12	M 13	M 21

\*available on request

# UTP A DUR 350

anti-wear

## Classifications

solid wire

EN 14700	DIN 8555	Material-No.
SZ Fe 2	MSG 2-GZ-400	1.8405

## Characteristics and field of use

UTP A DUR 350 is suited for MAG buildups on structural parts subject to compression, impact and abrasion, such as caterpillar track components, machine and gear parts, stamps.

The weld deposit of UTP A DUR 350 may be soft annealed and hardened.  
Post-weld machining by grinding is possible.

Hardness of the pure weld deposit :

untreated	approx. 450 HB
hardened 820 – 850 °C / oil	approx. 62 HRC
soft annealed 720 – 740 °C	approx. 200 HB
1 layer on non-alloyed steel	approx. 350 HB

## Typical analysis in %

C	Si	Mn	Cr	Ti	Fe
0.7	0.3	2.0	1.0	0.2	balance

## Welding instructions

Machine welding area has to be metallic bright. Massive parts have to be preheated to 200 – 300 °C.

## Form of delivery and recommended welding parameters

Wire diameter [mm]	Current type	Shielding gas (EN ISO 14175)		
1.0	DC (+)	M 12	M 13	M 21
1.2	DC (+)	M 12	M 13	M 21

**UTP A DUR 600**

anti-wear

**Classifications**

solid wire

EN 14700

DIN 8555

Material-No.

S Fe 8

MSG 6-GZ-60-S

1.4718

**Characteristics and field of use**

UTP A DUR 600 is universally applicable for MAG buildups on structural parts subject to high impact and medium abrasion. Main applications are found in quarries, crushing plants, mines, steel works, cement works as well as cutting tools and dies in the car industry. Despite the high hardness, the deposit is very tough, crack resistant and has an excellent cutting behaviour.

Despite the high hardness, the weld deposit of UTP A DUR 600 is tough, crack resistant and has a good cutting capacity. Machining by grinding possible.

Hardness of the pure weld deposit

untreated

54 – 60 HRC

soft annealed 800 °C

approx. 250 HB

hardened 1000 °C / oil

approx. 62 HRC

1 layer on non-alloyed steel

approx. 53 HRC

**Typical analysis in %**

C	Si	Mn	Cr	Fe
0.5	3.0	0.5	9.5	balance

**Welding instructions**

Grind the welding area to metallic bright. Generally, only tool steels have to be preheated to 450 °C.

**Form of delivery and recommended welding parameters**

Wire diameter [mm]	Current type	Shielding gas (EN ISO 14175)			
0.8	DC (+)	M 12	M 13	M 21	C 1
1.0	DC (+)	M 12	M 13	M 21	C 1
1.2	DC (+)	M 12	M 13	M 21	C 1
1.6	DC (+)	M 12	M 13	M 21	C 1

# UTP A DUR 650

anti-wear

## Classifications

solid wire

EN 14700

DIN 8555

S Fe 8

MSG 3-GZ-60

## Characteristics and field of use

UTP A DUR 650 is universally used for MAG buildups on structural parts subject to high impact and abrasion. Main applications are rail tamping tools, percussion tools, tool holders, shredder hammers, parts of stone treatment industry, press moulds for production of abrasive parts. Also as final layer on hard Mn-steel. Machining by grinding is possible.

UTP A DUR 650 has excellent welding properties, even and finely rippled bead formation and a very good slag removal. Welding with low current settings if possible (e.g. cutting edges). Service temperature up to 550 °C.

Hardness of the pure weld deposit: 55 – 60 HRC

## Typical analysis in %

C	Si	Mn	Cr	Mo	V	W	Fe
0.36	1.1	0.4	5.2	1.4	0.3	1.3	balance

## Welding instructions

Grind welding area. Preheating up to 450 °C, depending on the base material and wall thickness. If more than 3 layers are needed, weld buffer layers or buildups with UTP A DUR 250.

## Form of delivery and recommended welding parameters

Wire diameter [mm]	Current type	Shielding gas (EN ISO 14175)		
1.0*	DC (+)	M 12	M 13	M 21
1.2	DC (+)	M 12	M 13	M 21
1.6*	DC (+)	M 12	M 13	M 21

\*available on request

## List of contents

### FCAW-G – gas-shielded cored wires

<b>Description of the FCAW process</b>	<b>205</b>
<b>Flux-cored wires for repair of cracked material</b>	<b>206</b>
1. Unalloyed and low-alloyed steels	206
2. Stainless steels	208
<b>Gas-shielded cored wires for repair, anti-wear and anti-corrosion applications</b>	<b>222</b>
1. Manganese steels	222
2. Low-alloyed steels	226
3. High-alloyed steels	240
4. Tool steels	250
5. Cobalt alloys	268
6. Nickel alloys	280
7. Stainless steels	292
<b>Gas-shielded flux-cored wire</b>	<b>306</b>
1. Seamless flux-cored wires for automated welding	306

## Description of the FCAW process

*FCAW = Flux-cored Arc Welding*

**Flux-cored arc welding is a flexible method that offers high deposition rates, good weldability and excellent weld appearance.**

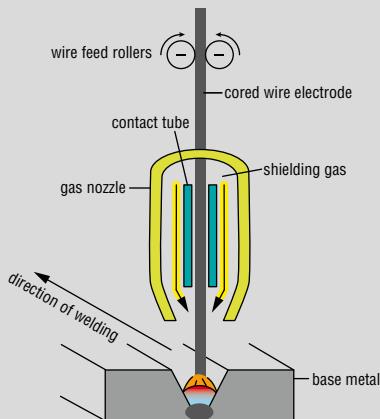

FCAW is commonly used for welding thicker sections (>5 mm). The high deposition rate also makes it suitable for overlay welding of mild and low-alloy steel components. FCAW welding is closely related to Gas Metal-Arc Welding (GMAW). The flux filled wire is automatically fed through the centre of the gun using the same equipment as when GMAW welding. The shielding gas is supplied through the gun and protects the weld pool from oxidation during welding. The flux inside the wire will protect the weld from the atmosphere since it forms a slag which covers the weld.

We recommend a shielding gas of either 75% Ar + 25% CO<sub>2</sub> or pure CO<sub>2</sub>. The difference between these concerns mainly the weldability, Ar + CO<sub>2</sub> being the best in horizontal welding and CO<sub>2</sub> in vertical welding. The FCAW process can easily be made automatic or semi-automatic. The method is very economical due to its high weld deposit rate. Just like any other gas-shielded process FCA welding is sensitive to draughts. Arrangements to avoid draughts should therefore be made when site welding.

## Flux-cored wires for repair of cracked material

### 1. Unalloyed and low-alloyed steels

Product name	EN ISO		AWS		Page
UTP AF 155	17632-A	T 46 4 M M 1 H5	A5.18	E70C-6MH4	207

#### Solution examples

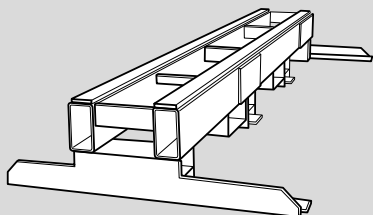

*Steel construction repair*

UTP AF 155



## Classifications

Gas-shielded flux-cored wire

EN ISO 17632-A

AWS A5.18

T 46 4 M M 1 H5

E70C-6MH4

## Characteristics and field of use

UTP AF 155 is a high-efficiency flux-cored wire with metal powder filling, for all position welding with mixed gas M21 acc. to EN ISO 14175. It features outstanding mechanical properties in temperature range down to  $-40^{\circ}\text{C}$  with very low fume level and oxide build up. The stable arc, the smooth droplet transfer, the secure penetration, its high deposition rate in the spray arc range and the high deposition efficiency of 98 % approx. are only some of the positive properties of this wire. It is characterized by almost spatter-free welding with good wall wetting, flat and concave weld shape, radiographical soundness and porosity free weld metal. It is suited for manual and mechanized welding for single and multilayers and root pass welding is proven in all positions.

## Base materials

S185, S235J2G3, S275JR, S355J2G3, E295, P235GH, P265GH, P295GH, P355GH (HI, HII, 17 Mn 4, 19 Mn 6), P275N, P355N, P355NL2, P460N, S275N, S275NL, S355N, S355NL, S460N, L210, L240, L290, L360, L290NB, L360MB, L415MB, X42 – X65 / StE 445.7 TM (API-5LX), GS-38 – GS-52, shipbuilding steels grade A – E, A32 – F32, A36 – F36, A40 – F40

## Typical analyses in %

C	Si	Mn	P	S
0.06	0.6	1.4	$\leq 0.02$	$\leq 0.02$

## Mechanical properties of the weld metal

Heat-treatment	Shielding gas	0.2%-Yield strength	Tensile strength	Elongation ( $L_{\sigma}=5d_0$ )	Impact values CVN	
		MPa	MPa	%	J	$-40^{\circ}\text{C}$
AW	M 21	460	560	22	130	50
580°C / 2h	M 21	460	560	22	120	50

## Welding position

	Current type DC (+) Shielding gas (EN ISO 14175) M 21 Consumption: 15 – 18 l / min
---	--

## Approvals

TÜV (No. 11193), DB (No. 42.132.48), BV, DNV GL, LR

## Form of delivery and recommended welding parameters

Diameter [mm]	Amperage [A]	Voltage [V]
1.2	120 – 350	18 – 33

Other diameters upon request

## Flux-cored wires for repair of cracked material

### 2. Stainless steels

Product name	EN ISO	AWS	Mat. -No.	Page
UTP AF 68 LC	17633-A T 19 9 L RM3 T 19 9 L RC3	A5.22	E308LT-0-1 E308LT-0-4	1.4316 209
UTP AF 68 LC PW	17633-A T 19 9 L P M21 1 T 19 9 L P C1 1	A5.22	E308LT1-4 E308LT1-1	210
UTP AF 68 MoLC	17633-A T 19 12 3 L RM3 T 19 12 3 L RC3	A5.22	E 316 LT0-1 E 316 LT0-4	1.4430 211
UTP AF 68 MoLC PW	17633-A T 19 12 3 L P M21 1 T 19 12 3 L P C1 1	A5.22	E316LT1-4 E316LT1-1	212
UTP AF 6222 MoPW	12153 T Ni 6625 PM 2	A5.34	ENiCrMo3 T1-4	2.4621 213
UTP AF 6808 Mo	17633-A T 22 9 3 N L R M21 3	A5.22	E2209T0-4 E2209T0-1	214
UTP AF 6808 Mo PW	17633-A T 22 9 3 N L P M21 1 T 22 9 3 N L P C1 1	A5.22	E2209T1-4 E2209T1-1	216
UTP AF 6824 LC	17633-A T 23 12 L RM3 T 23 12 L RC3	A5.22	E309LT0-1 E309LT0-4	1.4332 218
UTP AF 6824 LC PW	17633-A T 23 12 L P M21 1 T 23 12 L P C1 1	A5.22	E309LT1-4 E309LT1-1	220

#### Solution examples

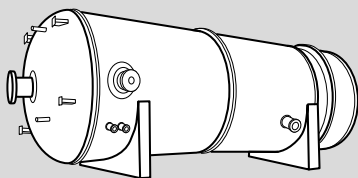

*Pressure vessel*

UTP AF 68 LC

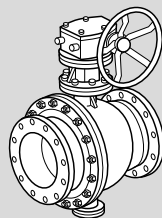

*Pump*

UTP AF 68 MoLC

<b>Classifications</b>		Gas-shielded flux-cored wire
EN ISO 17633-A	AWS A5.22	Material-No.
T 19 9 L R M21 / C1 3	E 308 LT-0-1 / E 308 LT-0-4	1.4316

### Characteristics and field of use

UTP AF 68 LC is a low carbon, CrNi flux-cored wire with rutile slag used for joint-welding of alloyed CrNi steels and cast steels.

The weld metal shows sufficient grain stability up to 350 °C and is scaling resistant up to 800 °C.

### Base materials

Material-No.	.55AISI	UNS	EN Symbol
1.4300	302	S30200	X12 CrNi 18 8
1.4301	304	S30400	X5 CrNi 18 10
1.4306	304L	S30403	X2 CrNi19 11
1.4311	304LN	S30453	X2 CrNiN 18 10
1.4312	305	J92701	GX10 CrNi 18 8
1.4303	308	S30800	X4 CrNi 18 12
1.4541	321	S32100	X6 CrNiTi 18 10
1.4550	347	S34700	X6 CrNiNb 18 10

### Typical analysis in %

C	Si	Mn	Cr	Ni	Fe
0.025	0.6	1.5	19.5	10.0	balance

### Mechanical properties of the weld metal

Yield strength $R_{p0.2}$	Tensile strength $R_m$	Elongation $A$	Impact toughness $K_V$
MPa	MPa	%	J [RT]
380	560	35	70

### Welding instructions

Clean weld area thoroughly. Welding torch should be held slightly inclined, using the back-hand (drag) technique. Possibly weaving. Ar + 15 – 25 % CO<sub>2</sub> as shielding gas offers the best weldability. 100 % CO<sub>2</sub> can be also used, but the voltage should be increased by 2V.

### Welding positions



### Approvals

TÜV (No. 06365)

### Form of delivery and recommended welding parameters

Wire diameter [mm]	Amperage	Voltage [V]
0.9*	100 – 160	22 – 27
1.2	125 – 270	20 – 33
1.6*	200 – 350	25 – 35

\*available on request

# UTP AF 68 LC PW

stainless steels

## Classifications

Gas-shielded flux-cored wire

EN ISO 17633-A

AWS A5.22

T 19 9 L P M21 1 / T 19 9 L P C1 1

E308LT1-4 / E308LT1-1

## Characteristics and field of use

UTP AF 68 LC PW is a strip alloyed flux-cored wire with a rutile slag characteristic for position welding of austenitic CrNi steels. The support provided by the fast-hardening slag allows out-of-position welding with high current magnitudes and high welding speeds. The fine droplet, low-spatter, very powerfully welding spray arc, the reliable fusion penetration, the self-releasing slag and the effectively wetting seam formation result in a high weld quality at the same time as short welding times. Additional advantages to its application result from the ease of handling, the low heat input due to the high welding speed, and the small amounts of cleaning and pickling required. UTP AF 68 LC PW is preferred for flat and horizontal welding positions (PA, PB). The weld metal is cryogenic down to  $-196^{\circ}\text{C}$  and resists intergranular corrosion up to  $+350^{\circ}\text{C}$ .

## Base materials

1.4306 X2CrNi19-11, EN 1.4301 X5CrNi18-10, EN 1.4311 X2CrNiN18-10, EN 1.4312 GX10CrNi18-8, EN 1.4541 X6CrNiTi18-10, EN 1.4546 X5CrNiNb18-10, EN 1.4550 X6CrNiNb18-10, AISI 304, 304L, 304LN, 302, 321, 347, ASTM A157 Gr. C9, A320 Gr. B8C or D

## Typical analysis in %

C	Si	Mn	Cr	Ni
0.03	0.7	1.5	19.8	10.5

## Mechanical properties of the weld metal

Welded condition	Yield strength $R_{p0.2}$	Tensile strength $R_m$	Elongation A	Impact toughness $K_V$	
	MPa	MPa	%	J [RT]	$-196^{\circ}\text{C}$
untreated	380	560	40	70	40

shielding gas Ar + 18% CO<sub>2</sub>

## Welding instructions

Welding with conventional MAG devices, slightly trailing torch position (angle of incidence about  $80^{\circ}$ ), slight weaving of the torch is recommended in all positions. With 100% CO<sub>2</sub> the voltage must be raised by 2V. The gas quantity should be 15 – 18 l / min.

## Welding positions



Current type DC (+)  
Shielding gases: Argon + 15 - 25% CO<sub>2</sub>, 100% CO<sub>2</sub>

## Approvals

TÜV (09117.), DB (43.014.23), CWB (E308LT1-1(4)), DNV GL, CE

## Form of delivery and recommended welding parameters

Wire diameter [mm]	Amperage [A]	Voltage [V]
1.2	100 – 220	20 – 31
1.6	175 – 260	21 – 29

**Classifications**

Gas-shielded flux-cored wire

EN ISO 17633-A	AWS A5.22	Material-No.
T 19 12 3 L R M21 / C1 3	E 316 LT0-1 / E 316 LT0-4	1.4430

**Characteristics and field of use**

UTP AF 68 LC is a low carbon, CrNi flux-cored wire with rutile slag for joining and surfacing of CrNi steels and cast steel.

The weld metal shows sufficient grain stability up to 350 °C and is scaling resistant up to 800 °C.

**Base materials**

Material-No.	AISI	UNS	EN
1.4401	316	S31600	X5 CrNiMo 17-12-2
1.4404	316L	S31603	X2 CrNiMo 17-12-2
1.4406	316LN	S31653	X2 CrNiMoN 17-12-2
1.4571	316Ti	S31635	X6 CrNiMoTi 17-12-2
1.4583	318	S31640	X10 CrNiMoNb 18-12

**Typical analysis in %**

C	Si	Mn	Cr	Mo	Ni	Fe
0.025	0.6	1.5	19.5	2.7	12.5	balance

**Mechanical properties of the weld metal**

Yield strength $R_{p0.2}$	Tensile strength $R_m$	Elongation $A$	Impact toughness $K_V$
MPa	MPa	%	J [RT]
400	560	35	55

**Welding instructions**

Clean weld area thoroughly. Welding torch should be held slightly inclined, using the push-technique. Possibly weaving.

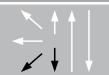
**Welding positions**

Current type DC (+)  
Shielding gases: Argon + 15 - 25 % CO<sub>2</sub>, 100 % CO<sub>2</sub>

**Approvals**

TÜV (No. 06366)

**Form of delivery and recommended welding parameters**

Wire diameter [mm]	Amperage	Voltage [V]
0.9*	100 – 160	21 – 30
1.2	125 – 260	20 – 34
1.6*	200 – 300	25 – 35

\*available on request

## UTP AF 68 MoLC PW

stainless steels

### Classifications

Gas-shielded flux-cored wire

EN ISO 17633-A

AWS A5.22

T 19 12 3 L P M21 1 / T 19 12 3 L P C1 1

E316LT1-4 / E316LT1-1

### Characteristics and field of use

UTP AF 68 MoLC PW is a flux-cored wire with a rutile slag characteristic for position welding of austenitic CrNiMo steels. The support provided by the fast-hardening slag allows out-of-position welding with high current magnitudes and high welding speeds. The fine droplet, low-spatter, very powerfully welding spray arc, the reliable fusion penetration, the self-releasing slag and the effectively wetting seam formation result in a high weld quality at the same time as short welding times. Additional advantages to its application result from the ease of handling, the low heat input due to the high welding speed, and the small amounts of cleaning and pickling required. UTP AF 68 MoLC PW is preferred for flat and horizontal welding positions (PA, PB). The weld metal is cryogenic down to  $-120^{\circ}\text{C}$  and resists intergranular corrosion up to  $+400^{\circ}\text{C}$ .

### Base materials

1.4306 X2CrNi19-11, EN 1.4301 X5CrNi18-10, EN 1.4311 X2CrNiN18-10, EN 1.4312 GX10CrNi18-8, EN 1.4541 X6CrNiTi18-10, EN 1.4546 X5CrNiNb18-10, EN 1.4550 X6CrNiNb18-10, AISI 304, 304L, 304LN, 302, 321, 347, ASTM A157 Gr. C9, A320 Gr. B8C or D

### Typical analysis in %

C	Si	Mn	Cr	Ni	Mo
0.03	0.7	1.5	19.0	12.0	2.7

### Mechanical properties of the weld metal

Welded condition	Yield strength $R_{p0.2}$	Tensile strength $R_m$	Elongation A	Impact toughness $K_V$	
	MPa	MPa	%	J [RT]	$-120^{\circ}\text{C}$
untreated	400	560	38	65	45

shielding gas Ar + 18% CO<sub>2</sub>

### Welding instructions

Welding with conventional MAG devices, slightly trailing torch position (angle of incidence about  $80^{\circ}$ ), slight weaving of the torch is recommended in all positions. With 100% CO<sub>2</sub> the voltage must be raised by 2V. The gas quantity should be 15 – 18 l / min.

### Welding positions



Current type DC (+)  
Shielding gases: Argon + 15 - 25% CO<sub>2</sub>, 100% CO<sub>2</sub>

### Approvals

TÜV (09118.), DB (43.014.24), CWB (E316LT1-1(4)), LR (DXV and O, BF 316LS), CE, DNV GL

### Form of delivery and recommended welding parameters

Wire diameter [mm]	Amperage [A]	Voltage [V]
1.2	100-220	20-31
1.6	175-260	21-29

## Classifications

Gas-shielded flux-cored wire

EN ISO 12153	AWS A 5.34	Material-No.
T Ni 6625 PM 2	ENiCrMo3 T1-4	2.4621

## Characteristics and field of use

The nickel-base-flux-cored wire (NiCrMo) UTP AF 6222 Mo PW is suitable for joining and surfacing on nickel-base materials of the same nature and on C- and CrNi steels as well as for cladding on C-steels, furthermore in high temperature applications.

2.4856	NiCr22Mo9Nb	N 06625	Alloy 625
1.4539	X NiCrMoCu25 20 5	N 08904	Alloy 904
1.4583	X NiCrNb18		
1.0562	12StE 355		
1.5662	X 8Ni9	ASTM A553	Typ 1

UTP AF 6222 Mo PW distinguishes by a hot cracking resistant and tough weld metal. It is suitable for operating temperatures up to 500 °C and above 800 °C. It must be noted that a slight decrease in ductility will occur if prolonged heat treatment is given within the temperature range 550 – 800 °C.

UTP AF 6222 Mo PW provides excellent positional welding. It has excellent welding properties with a regular and fine drop transfer. The weld seam is finely rippled and the transition from weld to base materials is regular and notch-free. The wide parameter range enables an application on different wall thicknesses.

## Typical analysis in %

C	Si	Mn	P	S	Cr	Mo	Ni	Nb	Fe
0.03	0.4	0.4	0.01	0.01	21.5	9.0	balance	3.5	0.5

## Mechanical properties of the weld metal

Yield strength $R_{p0.2}$	Tensile strength $R_m$	Elongation $A$	Impact toughness $K_V$	
MPa	MPa	%	J [RT]	- 196 °C
490	750	30	70	60

## Welding instructions

Clean welding area cautiously, slightly trailing torch position.

## Welding positions

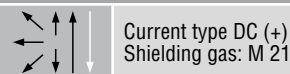

## Approvals

TÜV (No.10991)

## Form of delivery and recommended welding parameters

Wire diameter [mm]	Amperage	Voltage [V]
1.2	170 – 200	26 – 32

## UTP AF 6808 Mo

stainless steels

### Classifications

Gas-shielded flux-cored wire

EN ISO 17633-A

AWS A5.22

T 22 9 3 N L R M21 3 / T 22 9 3 N L R C1 3

E2209T0-4 / E2209T0-1

### Characteristics and field of use

UTP AF 6808 Mo is a duplex steel rutile flux-cored wire for gas-shielded arc welding primarily in flat and horizontal welding positions. It can provide an economical and qualitatively advantageous alternative to MAG welding of duplex steels.

The easy handling and high deposition rate of UTP AF 6808 Mo result in high productivity with excellent welding performance, self-releasing slag, very low spatter formation and surface oxidation, finely rippled weld pattern with good wetting behaviour and even, reliable fusion penetration. In addition to the significant savings in time and costs of processing techniques, including the lower requirement for cleaning and pickling.

The structure of the weld metal consists of austenite and ferrite (FN 30-50). The pitting resistance equivalent is  $PRE_N \geq 35$  (% Cr+3.3% Mo+16% N). In the welded and pickled condition, the weld metal is resistant, according to ASTM A262 – 93a, Pr.E, Pr.C, Pr.B and ASTM G48 / Method A up to 22 °C, and according to ASTM G48 / Method A (24 h) in the solution treated and pickled condition up to 30 °C. The welding consumable can be used in a temperature range from -40 °C up to +250 °C.

### Base materials

Same and similar alloyed duplex steels, as well as dissimilar joints or weld claddings.

EN 1.4462 X2CrNiMoN22-5-3, EN 1.4362 X2CrNiN23-4, EN 1.4162 X2CrNiMoN21-5-1; UNS S32205, S31803, S32304, S32101; Outokumpu 2205, 2304, LDX 2101<sup>®</sup>, SAF 2205, SAF 2304; 1.4462 X2CrNiMoN22-5-3 with 1.4583 X6CrNiMoNb17-13-3, 1.4462 X2CrNiMoN22-5-3 with P235GH/ P265GH, S255N, P295GH, S460N, etc.

### Typical analysis in %

C	Si	Mn	Cr	Ni	Mo	N	PRE <sub>N</sub>	Fn
≤0.03	0.8	0.9	22.7	9.0	3.2	0.13	35	30-50

### Mechanical properties of the weld metal

Welded condition	Yield strength	Tensile strength	Elongation	Impact toughness	
	$R_{p0.2}$	$R_m$	A	$K_V$	
	MPa	MPa	%	J [RT]	-40 °C
untreated	600	800	27	60	45

shielding gas Ar + 18% CO<sub>2</sub>



## UTP AF 6808 Mo

### Welding instructions

Welding with conventional MAG devices, slightly trailing torch position (angle of incidence about 80°); with 100 % CO<sub>2</sub> the voltage must be 2V higher.  
The gas quantity should be 15 – 18 l / min.

### Welding positions



Current type DC (+)  
Shielding gases: Argon + 15 - 25 % CO<sub>2</sub>

### Approvals

TÜV (07133.), ABS (E 2209 T0-4), CWB (E2209T0-4), DNV GL, LR (X (M21)),  
RINA (2209S), CE, DB (43.014.31)

### Form of delivery and recommended welding parameters

Wire diameter [mm]	Amperage [A]	Voltage [V]
1.2	125 – 280	22 – 36

**Classifications**

Gas-shielded flux-cored wire

EN ISO 17633-A

AWS A5.22

T 22 9 3 N L P M21 1 / T 22 9 3 N L P C1 1

E2209T1-4 / E2209T1-1

**Characteristics and field of use**

UTP AF 6808 Mo PW is a duplex steel rutile flux-cored wire for position welding of duplex steels in the chemical apparatus, plant and container construction, for chemical tankers and in the offshore industry. The support provided by the fast-hardening slag allows out-of-position welding with high current magnitudes and high welding speeds. The advantage of the slag is its supporting effect on the weld pool. This permits, for example, welding with the stringer bead technique at a correspondingly high welding speed even in difficult pipe welding positions (5G, 6G). The fine droplet, low-spatter, very powerfully welding spray arc, the reliable fusion penetration, the self-releasing slag and the effectively wetting seam formation result in a high weld quality at the same time as short welding times. Additional advantages to its application result from the ease of handling, the low heat input due to the high welding speed, and the small amounts of cleaning and pickling required.

The structure of the weld metal consists of austenite and ferrite (FN 30 - 50). The pitting resistance equivalent is  $PRE_N \geq 35$  (% Cr+3.3 % Mo+16 % N). Testing the weld metal in accordance with ASTM G48 Method A resulted in a CPT (critical pitting temperature) of 25 °C. Also suited to joining different materials and to weld cladding. Usable between -46 °C and +250 °C.

**Base materials**

Same and similar alloyed duplex steels, as well as dissimilar joints or weld claddings. EN 1.4462 X2CrNiMoN22-5-3, EN 1.4362 X2CrNiN23-4, EN 1.4162 X2CrNiMoN21-5-1; UNS S32205, S31803, S32304, S32101; Outokumpu 2205, 2304, LDX 2101®, SAF 2205, SAF 2304; 1.4462 X2CrNiMoN22-5-3 with 1.4583 X6CrNiMoNb17-13-3, 1.4462 X2CrNiMoN22-5-3 with P235GH/ P265GH, S255N, P295GH, S460N, etc.

**Typical analysis in %**

C	Si	Mn	Cr	Ni	Mo	N	PRE <sub>N</sub>	Fn
≤0.03	0.8	0.9	22.7	9.0	3.2	0.13	≥35	30–50

**Mechanical properties of the weld metal**

Welded condition	Yield strength	Tensile strength	Elongation	Impact toughness			
	$R_{p0.2}$	$R_m$	A	$K_V$	-20 °C	-40 °C	-46 °C
	MPa	MPa	%	J [RT]			
untreated	600	800	27	80	65	55	45

 shielding gas Ar + 18% CO<sub>2</sub>

## UTP AF 6808 Mo PW

### Welding instructions

Welding with conventional MAG devices, slightly trailing torch position (angle of incidence about 80°) ; slight weaving of the torch is recommended in all positions; with 100 % CO<sub>2</sub> the voltage must be 2 V higher. The gas quantity should be 15 – 18l / min.

### Welding positions



Current type DC (+)

Shielding gases: Argon + 15 - 25 % CO<sub>2</sub>, 100 % CO<sub>2</sub>

### Approvals

TÜV-D (07666.), ABS (E 22 09 T1-4(1)), CWB (E2209T1-1(4)), DNV GL, LR (X (M21,C1)), RINA (2209 S), CE

### Form of delivery and recommended welding parameters

Wire diameter [mm]	Amperage [A]	Voltage [V] [V]
1.2	100 – 220	20 – 31

## UTP AF 6824 LC

stainless steels

## Classifications

Gas-shielded flux-cored wire

EN ISO 17633-A

ASME II C SFA 5.22

Material-No.

T 23 12 L RM3 / T 23 12 L RC3

E 309 LT 0-1 / E 309 LT 0-4

1.4332

## Characteristics and field of use

UTP AF 6824 LC is a low-carbon flux-cored wire with rutile slag used for joint-welding of alloyed CrNi steels among each other or with other unalloyed or low-alloyed steels / cast steels.

(b+w joining).

Properties of the weld metal: The weld metal shows sufficient grain stability up to 350 °C and is scaling resistant up to 800 °C.

## Base materials

Material-No.	AISI	UNS	EN Symbol
1.4301	304	S 30400	X5 CrNi 18 10
1.4306	304 L	S 30403	X2 CrNi 19 11
1.4311	304 LN	S 30453	X2 CrNiN 18 10
1.4401	316	S 31600	X5 CrNiMo 17 12 2
1.4404	316 L	S 31603	X2 CrNiMo 17 13 2
1.4541	308	S 30800	X6 CrNiTi 18 10
1.4550	347	S 34700	X6 CrNiNb 18 10
1.4571	316 Ti	S 31635	X6 CrNiMoTi 17 12 2
1.4583	318	S 31640	G-X5 CrNiNb 19 11

Joining these materials with unalloyed and low-alloyed steels is possible.

## Typical analysis in %

C	Si	Mn	Cr	Ni	Fe
0.025	0.6	1.5	24.0	12.0	balance

## Mechanical properties of the weld metal

Yield strength $R_{p0.2}$	Tensile strength $R_m$	Elongation $A$	Impact toughness $K_V$
MPa	MPa	%	J [RT]
400	550	35	60

## Welding instructions

Clean weld area thoroughly. Welding torch should be held slightly inclined, using the backhand (drag) technique. Possibly weaving.

## Welding positions



Current type DC (+)

Shielding gases: Argon + 15 - 25% CO<sub>2</sub>, 100% CO<sub>2</sub>

## UTP AF 6824 LC

### Approvals

TÜV (No. 06364)

### Form of delivery and recommended welding parameters

<i>Wire diameter [mm]</i>	<i>Amperage</i>	<i>Voltage [V]</i>
0.9*	100 – 160	21 – 30
1.2	125 – 280	20 – 34
1.6*	200 – 350	25 – 35

\*available on request

## UTP AF 6824 LC PW

stainless steels

## Classifications

Gas-shielded flux-cored wire

EN ISO 17633-A

AWS A5.22

T 23 12 L P M21 1 / T 23 12 L P C1 1

E309LT1-4 / E309LT1-1

## Characteristics and field of use

Rutile, flux-cored wire with fast freezing slag for position welding of dissimilar joints, and for the first layer of weld claddings of unalloyed and low-alloy base materials. The support provided by the fast-hardening slag allows out-of-position welding with high current magnitudes and high welding speeds.

The fine droplet, low spatter, very intense spray arc, the reliable fusion penetration, the self-releasing slag and the good wetting behaviour result in a high weld quality at the same time as short welding times. Additional advantages to its application are the ease of handling, the low heat input resulting from the high welding speed, and the small amounts of cleaning and pickling required. UTP AF 6824 LC PW should be used for flat and horizontal welding positions (PA, PB). The weld metal is suitable for operating temperatures between -60 °C and +300 °C.

## Base materials

Joints: of and between high-strength, unalloyed and alloyed quenched and tempered steels, stainless, ferritic Cr and austenitic CrNi steels, austenitic manganese steels and weld claddings: for the first layer of chemically resistant weld claddings on the ferritic-pearlitic steels used for boiler and pressure vessel construction up to finegrained structural steel S500N, and for the creep resistant fine-grained structural steels 22NiMoCr4-7, 20MnMoNi5-5 and GS-18NiMoCr 3 7

## Typical analysis in %

C	Si	Mn	Cr	Ni
0.03	0.7	1.4	23.0	12.5

## Mechanical properties of the weld metal

Welded condition	Yield strength	Tensile strength	Elongation	Impact toughness	
	$R_{p0.2}$	$R_m$	A	$K_V$	-60 °C
	MPa	MPa	%	J [RT]	
untreated	400	540	35	65	50

shielding gas Ar + 18% CO<sub>2</sub>

## Welding instructions

The gas quantity should be 15 – 18 l / min. Slightly trailing torch position (angle of incidence about 80°), slight weaving of the torch is recommended in all positions. It is recommended that the voltage is increased by 2V if the shielding gas is 100% CO<sub>2</sub>. Preheating and interpass temperatures are to be adapted to the base material.

## UTP AF 6824 LC PW

### Welding positions



Current type DC (+)

Shielding gases: Argon + 15 - 25 % CO<sub>2</sub>, 100% CO<sub>2</sub>

### Approvals

TÜV (09115.), DB (43.014.22), ABS (E309 LT 1 – 1(4)), LR (DXV and O, CMn / SS),  
CWB (E309LT0 – 1(4)), CE, DNV GL, RINA

### Form of delivery and recommended welding parameters

Wire diameter [mm]	Amperage [A]	Voltage [V]
1.2	100 – 220	20 – 31
1.6	175 – 260	21 – 29

## Gas-shielded cored wires for repair, anti-wear and anti-corrosion

### 1. Manganese steels

Product name	DIN		HB	HRC	C	Mn	Si	Cr
SK 797-G	8555	MF 7-GF-200-KP	185		0.9	14.5	0.3	
SK AP-G	8555	MF 7-GF-200-KP	200		0.4	17.0	0.3	12.0

#### Solution examples

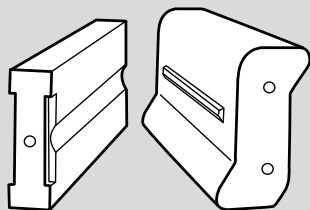

*Impactor bar*

SK 797-G



## applications

	Ni	Mo	Ti	W	V	B	Fe	Type of wear						Page	
								Low stress abrasion	High stress abrasion	Erosion	Impact	Corrosion	Cavitation		Metal to metal wear
		0.5					Bal.				■			■	224
							Bal.				■	■		■	225

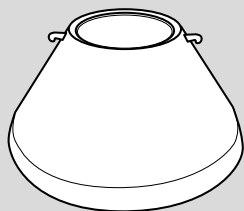

*Gyrotory crusher mantel*

SK AP-G

**SK 797-G**

manganese steels

**Classifications**

Gas-shielded flux-cored wire

DIN 8555

MF 7-GF-200-KP

**Characteristics**

Austenitic alloy without chromium designed for rebuilding 14 % manganese steel parts where parent-metal matching colour is a must.

Microstructure: Austenite

Machinability: Good with metallic carbide tipped tools

Oxy-acetylene cutting: Cannot be flame cut

Deposit thickness: Depends upon application and procedure used

Shielding gas: Argon 82 % + CO<sub>2</sub> 18 %

**Field of use**

Patching of Hadfield steel castings, crusher cylinders, crusher hammers, impactor bars.

**Typical analysis in %**

C	Mn	Si	Ni	Mo	Fe
0.9	14.5	0.3	2.0	0.5	balance

**Typical mechanical properties**

Hardness as welded: 185 HB

**Form of delivery and recommended welding parameters**

Wire diameter [mm]	Amperage [A]	Voltage [V]	Stick-out [mm]	Gas flow [L/min]
1.2	110 – 180	20 – 31	20 max.	12 – 15
1.6	150 – 250	20 – 31	20 max.	15 – 18

**SK AP-G**

manganese steels

**Classifications**

gas-shielded metal-cored wire

DIN 8555

ASME IIC SFA 5.21

MF 7-GF-200-KP

FeMn-Cr

**Characteristics**

Multi-purpose cored wire, mainly used for rebuilding and joining of carbon and 14 % manganese steels. Can also be used as buffer layer prior to hard overlay. Work-hardenable alloy.

Microstructure: Austenite

Machinability: Good with metallic carbide tipped tools

Oxy-acetylene cutting: Cannot be flame cut

Deposit thickness: As required

Shielding gas: Argon 98 % + Oxygen 2 %

**Field of use**

Railway rails and crossovers, mill shaft drive ends, gyratory crusher mantles, repointing of shovel teeth, buffer layer for inter-particles crushers.

**Typical analysis in %**

C	Mn	Si	Cr	Fe
0.4	17.0	0.3	12.0	balance

**Typical mechanical properties**

Hardness as welded: 200 HB

**Form of delivery and recommended welding parameters**

Wire diameter [mm]	Amperage [A]	Voltage [V] [V]	Stick-out [mm]	Gas flow [L/min]
1.6	150 – 250	20 – 31	20 max.	12 – 15

## Gas-shielded cored wire for repair, anti-wear and anti-corrosion

### 2. Low-alloyed steels

Product name	DIN		HB	HRC	C	Mn	Si	Cr
SK 250-G	8555	MF 1-GF-225-GP	225		0.09	1.2	0.5	0.4
SK 258-G	8555	MF 6-GF-55-GT		53	0.45	1.6	0.8	5.5
SK 258L-G	8555	MF 5-GF-45-GT		45	0.17	1.6	0.6	5.5
SK 258 TIC-G	8555	MF 6-GF-60-GP		59	1.6	0.8	0.3	5.6
SK 300-G	8555	MF 1-GF-300-GP	300		0.25	1.5	0.4	1.4
SK 350-G	8555	MF 1-GF-350-GP	330		0.35	1.5	0.4	1.8
SK 450-G	8555	MF 1-GF-450-GP		47	0.27	1.1	0.2	2.3
SK 500-G	8555	MF 6-GF-50-GT		52	0.26	1.3	0.7	5.0
SK 600-G	8555	MF 6-GF-60-GP		59	0.52	1.5	1.2	5.9
SK 600C-G	8555	MF 6-GF-60-GP		60	0.4	1.2	0.8	6.0
SK 650-G	8555	MF 3-GF-60-GT		58	0.45	0.9	0.6	5.5
SK A68-G	8555	MF 2-GF-65-G		62	0.5	1.3	1.0	

#### Solution examples

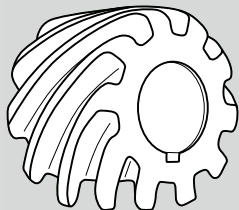

*Gear teeth*

SK 350-G

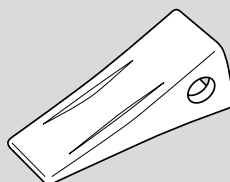

*Shovel teeth*

SK 500-G

## applications

	Ni	Mo	Ti	W	V	B	Fe	Type of wear							Page
								Low stress abrasion	High stress abrasion	Erosion	Impact	Corrosion	Cavitation	Metal to metal wear	
							Bal.				■				228
		1.3		1.3			Bal.	■			■			■	229
		1.5		1.5			Bal.	■			■			■	230
		1.1	5.8				Bal.	■			■			■	231
							Bal.				■				232
		0.5					Bal.				■				233
		0.5					Bal.				■				234
		0.5					Bal.				■				235
		0.8	0.05				Bal.	■			■			■	236
		0.7					Bal.	■			■			■	237
		1.4		1.6	0.5		Bal.	■			■			■	238
	1.6					3.7	Bal.	■			■			■	239

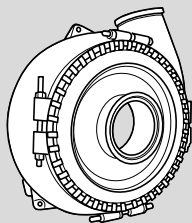

Gravel pump

SK 600-G

**SK 250-G**

low-alloyed steels

**Classifications**

gas-shielded metal-cored wire

DIN 8555

ASME IIC SFA 5.21

MF 1-GF-225-GP

ERC Fe-1

**Characteristics**

Metal-cored wire designed for building-up by welding in horizontal and vertical-up positions under gas shielding.

Microstructure: Ferrite + Perlite

Machinability: Good

Oxy-acetylene cutting: Possible

Deposit thickness: Depends upon application and procedure used

Shielding gas: Argon 82% + CO<sub>2</sub> 18%

**Field of use**

Conveyor chains, sliding metal parts, gear teeth, shafts.

**Typical analysis in %**

C	Mn	Si	Cr	Fe
0.09	1.2	0.5	0.4	balance

**Typical mechanical properties**

Hardness as welded: 225 HB

**Form of delivery and recommended welding parameters**

Wire diameter [mm]	Amperage [A]	Voltage [V] [V]	Stick-out [mm]	Gas flow [L/min]
1.2	110 – 180	20 – 31	20 max.	10 – 18
1.6	150 – 250	20 – 31	20 max.	10 – 18

**SK 258-G**

low-alloyed steels

**Classifications**

gas-shielded metal-cored wire

DIN 8555

MF 6-GF-55-GT

**Characteristics**

Martensitic alloy designed to give an outstanding resistance to low stress abrasion with heavy impact and high compressive stresses. The deposit is heat treatable and forgeable.

Microstructure: Martensite

Machinability: Grinding only

Oxy-acetylene cutting: Flame cut is difficult

Deposit thickness: Depends upon application and procedure used

Shielding gas: Argon 98 % + Oxygen 2 %

**Field of use**

Cable sheaves, bed knives, steel mill rollers, crane wheels, forging dies.

**Typical analysis in %**

C	Mn	Si	Cr	Mo	W	Fe
0.45	1.6	0.8	5.5	1.3	1.3	balance

**Typical mechanical properties**

Hardness as welded: 53 HRC

**Form of delivery and recommended welding parameters**

Wire diameter [mm]	Amperage [A]	Voltage [V]	Stick-out [mm]	Gas flow [L/min]
1.2	110 – 180	20 – 31	20 max.	12 – 15
1.6	150 – 300	20 – 31	20 max.	15 – 18
2.8	300 – 400	20 – 31	20 max.	20 – 22

**SK 258L-G**

low-alloyed steels

**Classifications**

gas-shielded metal-cored wire

DIN 8555

MF 5-GF-45-GT

**Characteristics**

Martensitic alloy designed to give an outstanding resistance to low stress abrasion with heavy impact and high compressive stresses. The deposit is heat treatable and forgeable.

Microstructure: Martensite

Machinability: Good with Tungsten carbides or cubic Boron Nitride tipped tools

Oxy-acetylene cutting: Flame cut is difficult

Deposit thickness: Depends upon application and procedure used

Shielding gas: Argon 98% + Oxygen 2%

**Field of use**

Steel mill rollers, blast furnace bells (seat area), dredger-buckets cylinders.

**Typical analysis in %**

C	Mn	Si	Cr	Mo	W	Fe
0.17	1.6	0.6	5.5	1.5	1.5	balance

**Typical mechanical properties**

Hardness as welded: 45 HRC

**Form of delivery and recommended welding parameters**

Wire diameter [mm]	Amperage [A]	Voltage [V]	Stick-out [mm]	Gas flow [L/min]
1.2	150 – 250	20 – 31	20 max.	12 – 15
1.6	180 – 300	20 – 31	20 max.	15 – 18
2.8	300 – 400	20 – 31	20 max.	20 – 22



## SK 258 TIC-G

low-alloyed steels

### Classifications

gas-shielded metal-cored wire

DIN 8555

MF 6-GF-60-GP

### Characteristics

Special Chromium-Titanium-Molybdenum martensitic alloy designed to resist high stress abrasion wear with heavy impact.

Microstructure: Finely dispersed Titanium carbides in a Martensitic matrix

Machinability: Grinding only

Oxy-acetylene cutting: Cannot be flame cut

Deposit thickness: Up to 6 layers

Shielding gas: Argon 98 % + Oxygen 2 %

### Field of use

Bucket teeth and lips, inter-particles crusher roller, concrete pump parts, augers, crusher hammers, shredder hammers, crusher hammers, asphalt mixers blades, concrete pump parts.

### Typical analysis in %

C	Mn	Si	Cr	Mo	Ti	Fe
1.6	0.8	0.3	5.6	1.1	5.8	balance

### Typical mechanical properties

Hardness as welded: 59 HRC

### Form of delivery and recommended welding parameters

Wire diameter [mm]	Amperage [A]	Voltage [V]	Stick-out [mm]	Gas flow [L/min]
1.2	150 – 250	26 – 29	15 – 20	12 – 15
1.6	180 – 300	26 – 29	15 – 20	15 – 18

**SK 300-G**

low-alloyed steels

**Classifications**

gas-shielded metal-cored wire

DIN 8555

MF 1-GF-300-GP

**Characteristics**

Build-up alloy designed for welding in horizontal and vertical-up positions under gas shielding.

Microstructure: Bainite

Machinability: Good

Oxy-acetylene cutting: Cannot be flame cut

Deposit thickness: Depends upon application and procedure used

Shielding gas: Argon 82% + CO<sub>2</sub> 18%

**Field of use**

Conveyor chains, sliding metal parts, gear teeth, crane wheels, undercarriage links, shafts, buffer layer prior to hardfacing.

**Typical analysis in %**

C	Mn	Si	Cr	Fe
0.25	1.5	0.4	1.4	balance

**Typical mechanical properties**

Hardness as welded: 300 HB

**Form of delivery and recommended welding parameters**

Wire diameter [mm]	Amperage [A]	Voltage [V]	Stick-out [mm]	Gas flow [L/min]
1.2	110 – 180	20 – 31	20 max.	12 – 15
1.6	150 – 250	20 – 31	20 max.	15 – 18

**Classifications**

gas-shielded metal-cored wire

DIN 8555

MF 1-GF-350-GP

**Characteristics**

Rebuilding and hardfacing alloy for carbon steel parts.

Microstructure: Bainite

Machinability: Good

Oxy-acetylene cutting: Cannot be flame cut

Deposit thickness: Depends upon application and procedure used

Shielding gas: Argon 82% + CO<sub>2</sub> 18% or CO<sub>2</sub> 100%**Field of use**

Sliding metal parts, gear teeth, undercarriage links, rollers and idlers, shafts, bushing.

**Typical analysis in %**

C	Mn	Si	Cr	Mo	Fe
0.35	1.5	0.4	1.8	0.5	balance

**Typical mechanical properties**

Hardness as welded: 330 HB

**Form of delivery and recommended welding parameters**

Wire diameter [mm]	Amperage [A]	Voltage [V]	Stick-out [mm]	Gas flow [L/min]
1.2	110 – 180	20 – 31	20 max.	12 – 15
1.6	150 – 250	20 – 31	20 max.	15 – 18
2.0	200 – 325	20 – 31	20 max.	15 – 18
2.4	250 – 350	20 – 31	20 max.	18 – 20

**SK 450-G**

low-alloyed steels

**Classifications**

gas-shielded metal-cored wire

DIN 8555

ASME IIC SFA 5.21

MF 1-GF-450-GP

ERC Fe-2

**Characteristics**

Rebuilding and hardfacing alloy designed for welding in horizontal and vertical-up positions under gas shielding.

Microstructure: Martensite

Machinability: Good

Oxy-acetylene cutting: Cannot be flame cut

Deposit thickness: Depends upon application and procedure used

Shielding gas: Argon 82% + CO<sub>2</sub> 18% or CO<sub>2</sub> 100%

**Field of use**

Undercarriage rollers and idlers, crane wheels, sealing rings seats.

**Typical analysis in %**

C	Mn	Si	Cr	Mo	Fe
0.27	1.1	0.2	2.3	0.5	balance

**Typical mechanical properties**

Hardness as welded: 47 HRC

**Form of delivery and recommended welding parameters**

Wire diameter [mm]	Amperage [A]	Voltage [V]	Stick-out [mm]	Gas flow [L/min]
1.2	110 – 180	20 – 31	20 max.	12 – 15
1.6	150 – 250	20 – 31	20 max.	15 – 18

**SK 500-G**

low-alloyed steels

**Classifications**

gas-shielded metal-cored wire

DIN 8555

MF 6-GF-50-GT

**Characteristics**

Rebuilding and hardfacing alloy designed for welding in horizontal and vertical-up positions under gas shielding.

Microstructure: Martensite

Machinability: Grinding only

Oxy-acetylene cutting: Flame cut is difficult

Deposit thickness: Depends upon application and procedure used

Shielding gas: Argon 82 % + CO<sub>2</sub> 18 % or CO<sub>2</sub> 100 %

**Field of use**

Undercarriage rollers and idlers, shovel teeth, shear blades.

**Typical analysis in %**

C	Mn	Si	Cr	Mo	Fe
0.26	1.3	0.7	5.0	0.5	balance

**Typical mechanical properties**

Hardness as welded: 52 HRC

**Form of delivery and recommended welding parameters**

Wire diameter [mm]	Amperage [A]	Voltage [V]	Stick-out [mm]	Gas flow [L/min]
1.6	150 – 250	20 – 31	20 max.	15 – 18

**SK 600-G**

low-alloyed steels

**Classifications**

gas-shielded metal-cored wire

DIN 8555

MF 6-GF-60-GP

**Characteristics**

Martensitic steel alloy designed for welding in horizontal and vertical-up positions under gas shielding. Its resistance to friction and low stress abrasive wear with moderate impact is excellent.

Microstructure: Martensite

Machinability: Grinding only

Oxy-acetylene cutting: Flame cut is difficult

Deposit thickness: Depends upon application and procedure used

Shielding gas: Argon 82% + CO<sub>2</sub> 18% or CO<sub>2</sub> 100%

**Field of use**

Bucket teeth, gravel pumps, conveyor chains, sliding metal parts, gear teeth, crusher hammers, rock drills

**Typical analysis in %**

C	Mn	Si	Cr	Mo	Ti	Fe
0.52	1.5	1.2	5.9	0.8	0.05	balance

**Typical mechanical properties**

Hardness as welded: 59 HRC

**Form of delivery and recommended welding parameters**

Wire diameter [mm]	Amperage [A]	Voltage [V]	Stick-out [mm]	Gas flow [L/min]
0.9	80 – 170	17 – 30	20 max.	12 – 15
1.2	110 – 180	20 – 31	20 max.	12 – 15
1.6	150 – 250	20 – 31	20 max.	15 – 18

**SK 600C-G**

low-alloyed steels

**Classifications**

gas-shielded metal-cored wire

DIN 8555

MF 6-GF-60-GP

**Characteristics**

Premium martensitic steel alloy designed for welding at low parameters in horizontal positions under gas shielding. Its resistance to friction and low stress abrasion wear with moderate impact is excellent.

Microstructure: Martensite

Machinability: Grinding only

Oxy-acetylene cutting: Flame cut is difficult

Deposit thickness: 3.5 – 4.0 mm in one layer

Shielding gas: Argon 82% + CO<sub>2</sub> 18%

**Field of use**

Automatic surfacing of corners and edges of cutting tools.

**Typical analysis in %**

C	Mn	Si	Cr	Mo	Fe
0.4	1.2	0.8	6.0	0.7	balance

**Typical mechanical properties**

Hardness as welded: 60 HRC

**Form of delivery and recommended welding parameters**

Wire diameter [mm]	Amperage [A]	Voltage [V]	Stick-out [mm]	Gas flow [L/min]
1.2	130 – 160	17 – 20	20 max.	12 – 15

**SK 650-G**

low-alloyed steels

**Classifications**

gas-shielded metal-cored wire

DIN 8555

MF 3-GF-60-GT

**Characteristics**

Martensitic steel alloy designed for welding in horizontal and vertical-up positions under gas shielding. Its resistance to friction and medium stress abrasive wear with moderate impact is excellent.

Microstructure: Martensite

Machinability: Grinding only

Oxy-acetylene cutting: Flame cut is difficult

Deposit thickness: Depends upon application and procedure used

Shielding gas: Argon 82 % + CO<sub>2</sub> 18 % or CO<sub>2</sub> 100 %

**Field of use**

Dies, sliding metal parts, bucket teeth, gear teeth, crusher hammers, impact drills, etc.

**Typical analysis in %**

C	Mn	Si	Cr	Mo	W	V	Fe
0.45	0.9	0.6	5.5	1.4	1.6	0.5	balance

**Typical mechanical properties**

Hardness as welded: 58 HRC

**Form of delivery and recommended welding parameters**

Wire diameter [mm]	Amperage [A]	Voltage [V]	Stick-out [mm]	Gas flow [L/min]
1.2	110 – 180	20 – 31	20 max.	12 – 15
1.6	150 – 250	20 – 31	20 max.	15 – 18



**SK A68-G**

low-alloyed steels

**Classifications**

gas-shielded metal-cored wire

DIN 8555

MF 2-GF-65-G

**Characteristics**

Hardfacing alloy giving an excellent resistance to medium stress abrasive wear with moderate impact. A very high hardness is already achieved in the first layer.

Machinability: Grinding only

Oxy-acetylene cutting: Flame cut is difficult

Deposit thickness: Depends on application and procedure used

Shielding gas: Argon 98 % + Oxygen 2 %

**Field of use**

Mixers and scrapers, excavator buckets, press screws parts.

**Typical analysis in %**

C	Mn	Si	Ni	B	Fe
0.5	1.3	1.0	1.6	3.7	balance

**Typical mechanical properties**

Hardness as welded: 62 HRC

**Form of delivery and recommended welding parameters**

Wire diameter [mm]	Amperage [A]	Voltage [V]	Stick-out [mm]	Gas flow [L/min]
1.2	110 – 250	20 – 31	20 max.	12 – 15
1.6	110 – 300	20 – 31	20 max.	15 – 20

## Gas-shielded cored wire for repair, anti-wear and anti-corrosion

### 3. High-alloyed steels

Product name	DIN		HB	HRC	C	Mn	Si	Cr	Ni
SK 255-G	8555	UP 10-GF-60-G		58	4.5	0.6	1.2	26.0	
SK 258 NbC-G	8555	UP 6-GF-55-G		54	1.3	0.9	1.1	7.0	
SK A45-G	8555	MF 10-GF-65-GT		63	5.3	0.1	0.7	21.0	
SK A70-0 / G	8555	MF 10-GF-70-G		68	2.6	1.7	0.6	14.8	
SK ABRA-MAX-O / G	8555	MF 6-GF-70-GT		70	+	+	+	+	
SK CuAl10-G	EN 14700	T Cu1	260		0.02	0.9	0.1		4.2
SK HYDROCAV	8555	MF 6-GF-200-K	220		0.17	8.5	1.8	21.0	

#### Solution examples

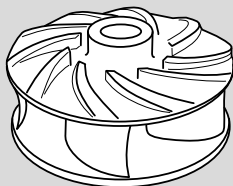

*Dredge pump impeller*

SK 255-G

# applications

	Mo	Nb	W	V	B	Fe	Type of wear High-alloyed							Page	
							Low stress abrasion	High stress abrasion	Erosion	Impact	Corrosion	Cavitation	Metal to metal wear		Heat
					0.3	Bal.		■							242
		8.5	1.4			Bal.	■			■					243
	6.3	6.0	1.8	0.75		Bal.		■						■	244
		4.7			2.2	Bal.		■							245
	+	+	+	+	+	Bal.		■	■						246
	Other: Al = 10.5 / Cu = Bal.					1.5					■	■			247
	Other: Co = 12.0 / N = 0.25					Bal.			■		■	■	■		248

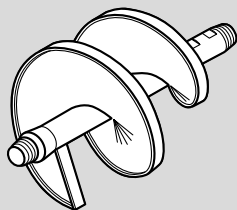

Auger

SK A70-0 / G

**SK 255-G**

high-alloyed steels

**Classifications**

gas-shielded metal-cored wire

DIN 8555

ASME IIC SFA 5.21

UP 10-GF-60-G

FeCr-A9

**Characteristics**

Gas-shielded cored wire designed to deposit an alloy resistant to high stress grinding abrasion with low impact. The deposits will readily show stress relief cracks.

Microstructure: Primary carbides and eutectic carbides in an austenitic matrix

Machinability: Grinding only

Oxy-acetylene cutting: Cannot be flame cut

Deposit thickness: 8 to 10 mm maximum in 2 to 3 layers

Shielding gas: Argon 98% + Oxygen 2%

**Field of use**

Palm oil expeller screws, groundnut oil expeller screws, cement conveyors screws, catalytic pipes, dredge pump impellers, dredge cutters, shovel bucket teeth.

**Typical analysis in %**

C	Mn	Si	Cr	B	Fe
4.5	0.6	1.2	26.0	0.3	balance

**Typical mechanical properties**

Hardness as welded: 58 HRC

**Form of delivery and recommended welding parameters**

Wire diameter [mm]	Amperage [A]	Voltage [V]	Stick-out [mm]	Gas flow [L/min]
1.6	150 – 250	20 – 31	20 max.	15 – 18

**SK 258 NbC-G**

high-alloyed steels

**Classifications**

gas-shielded metal-cored wire

DIN 8555

UP 6-GF-55-G

**Characteristics**

Gas-shielded flux-cored wire designed to deposit a crack-free martensitic alloy.

Microstructure: Martensite, little residual austenite and dispersed NbC carbides

Precautions: Preheating temperature 250 °C  
Interpass temperature 300 °C

Stress-relieving: 500 °C for 6 to 8 hours

Machinability: Grinding only

Oxy-acetylene cutting: Cannot be flame cut

Deposit thickness: Depends upon application and procedure used

Shielding gas: Argon 98 % + Oxygen 2 %

**Field of use**

Inter-particles crusher rollers.

**Typical analysis in %**

C	Mn	Si	Cr	Nb	W	Fe
1.3	0.9	1.1	7.0	8.5	1.4	balance

**Typical mechanical properties**

Hardness as welded: 54 HRC

**Form of delivery and recommended welding parameters**

Wire diameter [mm]	Amperage [A]	Voltage [V]	Stick-out [mm]	Gas flow [L/min]
1.6	150 – 300	20 – 31	20 max.	15 – 18

**SK A45-G**

high-alloyed steels

**Classifications**

gas-shielded metal-cored wire

DIN 8555

MF 10-GF-65-GT

**Characteristics**

Chromium-Niobium-Molybdenum alloy with addition of Tungsten and Vanadium designed to resist high stress grinding abrasion with low impact and solid erosion at service temperatures up to 650 °C. The deposits will readily show stress relief cracks.

Microstructure: Austenitic matrix with hexagonal primary and eutectic carbides and nodular Nb carbides with complex combined carbides

Machinability: Grinding only

Oxy-acetylene cutting: Cannot be flame cut

Deposit thickness: 8 to 12 mm in 2 or 3 layers

Shielding gas: Argon + 2 % Oxygen

**Field of use**

Wear plates, sinter finger crushers, exhaust fan blades in pellet plants, perlite crushers, bucket teeth and lips on bucketwheel excavators, boiler fan blades, burden area in blast furnace bells, etc.

**Typical analysis in %**

C	Mn	Si	Cr	Mo	Nb	W	V	Fe
5.3	0.1	0.7	21.0	6.3	6.0	1.8	0.75	balance

**Typical mechanical properties**

Hardness as welded: 63 HRC

**Form of delivery and recommended welding parameters**

Wire diameter [mm]	Amperage [A]	Voltage [V]	Stick-out [mm]
1.6	180 – 200	26 – 30	20 max.

**Classifications**

gas-shielded metal-cored wire

DIN 8555

MF 10-GF-70-G

**Characteristics**

Special Chromium-Niobium-Boron alloy designed to give extreme resistance to high stress grinding abrasion without impact. The typical hardness is achieved in the first layer. The deposits will show stress relief cracks.

Microstructure: Borides and Niobium carbides in eutectic matrix

Machinability: Grinding only

Oxy-acetylene cutting: Cannot be flame cut

Deposit thickness: 6 to 8 mm in 2 layers maximum

Shielding gas: Argon 98 % + Oxygen 2 % (if not used as open-arc)

**Field of use**

Extrusion screws, screw conveyors, mixers, scrapers, subsoiler teeth, agriculture and earth moving machinery wear parts, etc.

**Typical analysis in %**

C	Mn	Si	Cr	Nb	B	Fe
2.6	1.7	0.6	14.8	4.7	2.2	balance

**Typical mechanical properties**

Hardness as welded: 68 HRC

**Form of delivery and recommended welding parameters**

Wire diameter [mm]	Amperage [A]	Voltage [V]	Stick-out [mm]	Gas flow [L/min]
1.2	110 – 180	20 – 31	20 max.	12 – 15
1.6	150 – 250	20 – 31	20 max.	15 – 18
2.4	200 – 300	20 – 31	20 max.	18 – 20

**SK ABRA-MAX O / G**

high-alloyed steels

**Classifications**

gas-shielded metal-cored wire

DIN 8555

MF 6-GF-70-GT

**Characteristics**

Special hardfacing cored wire designed to give an extreme resistance against high stress grinding abrasion and erosion without impact. The typical mechanical properties can be achieved in the first layer. The deposit will readily show stress relief cracks.

Microstructure: Complex carbo-borides and borides homogeneously dispersed in the matrix

Machinability: Grinding only

Oxy-acetylene cutting: Cannot be flame cut

Deposit thickness: ca. 8 mm in maximum 2 layers

Shielding gas: Argon + 2% Oxygen ( if not used as open arc)

**Field of use**

Conveyors screws, crusher plates and rolls, shredder teeth, fan blades, bucket teeth and lips, agricultural machinery, wear plates, etc.

**Typical analysis**

C + Cr + Mo + Nb + W + V + B (Bal Fe)

**Typical mechanical properties**

Hardness as welded: 70 HRC

**Form of delivery and recommended welding parameters**

<i>Wire diameter [mm]</i>	<i>Amperage [A]</i>	<i>Voltage [V]</i>	<i>Stick-out [mm]</i>
1.2	130 – 180	22 – 26	15 – 25
1.6	180 – 230	26 – 30	20 – 40
2.4	250 – 300	26 – 30	20 – 40
2.8	300 – 350	26 – 30	35 – 40



**SK CuAl10-G**

high-alloyed steels

**Classifications**

gas-shielded metal-cored wire

DIN 8555

EN 14700

MSG-31-GF-250-C

T Cu1

**Characteristics**

Special copper-aluminium especially developed for the building up of aluminium bronze and parts subjected to metal to metal wear under high pressure.

Machinability: Good

Oxy-acetylene cutting: Cannot be flame cut

Deposit Overthickness: Depends upon application and procedure used

Shielding gas: Argon 50 % + Helium 50 %

Liner: A Teflon liner is advised

**Field of use**

Ship propellers, valves, bearings

**Typical analysis in %**

C	Mn	Si	Ni	Al	Fe	Cu
0.02	0.9	0.1	4.2	10.5	1.5	balance

**Typical mechanical properties**

Hardness as welded: 260 HB

**Form of delivery and recommended welding parameters**

Wire diameter [mm]	Amperage [A]	Voltage [V]	Stick-out [mm]	Gas flow [L/min]
1.6	200 – 250	27 – 29	20 max.	20 – 25

**SK HYDROCAV**

high-alloyed steels

**Classifications**

gas-shielded metal-cored wire

DIN 8555

MF 6-GF-200-K

**Characteristics**

The SK Hydrocav is gas-shielded metal-cored wire suitable for surfacing of parts (especially soft martensitic 13 / 4 stainless steels) where high resistance to cavitation, corrosion, pressure and impact is required. Work-hardenable alloy.

Microstructure: Austenite type

Machinability: Good

Oxy-acetylene cutting: Cannot be flame cut

Shielding gas: Ar + 2 % O<sub>2</sub>

**Field of use**

Turbine blades, pumps.

**Typical analysis in %**

C	Mn	Si	Cr	Co	N	Fe
0.17	8.5	1.8	21.0	12.0	0.25	balance

**Typical mechanical properties**

Hardness as welded: 220 HB

Hardness after work hard: 40 HRC

**Form of delivery and recommended welding parameters**

Wire diameter [mm]	Amperage [A]	Voltage [V]	Stick-out [mm]	Gas flow [L/min]
1.2	110 – 250	20 – 31	20 max.	15 – 18



## Gas-shielded cored wire for repair, anti-wear and anti-corrosion

### 4. Tool steels

Product name	DIN		HB	HRC	C	Mn	Si	Cr
SK D8-G	8555	MF 3-GF-40-T		38	0.1	1.1	0.4	2.4
SK D8S-G	8555	MF 3-GF-45-T		38	0.1	1.1	0.5	2.4
SK D11-G	8555	MF 3-GF-55-T		56	0.3	1.2	0.6	5.3
SK D12-G	8555	MF 3-GF-55-T		55	0.35	1.2	0.3	7.5
SK D12S-G	8555	MF 3-GF-55-T		56	0.38	1.2	0.5	7.5
SK D15-G	8555	MF 3-GF-60-T		60	0.4	0.5	0.4	1.4
SK D16-G	8555	MF 3-GF-50-T		51	0.28	0.5	0.4	8.5
SK D20-G	8555	MF 4-GF-60-S		60	1.2	0.4	0.4	4.5
SK D33-G	8555	MF 6-GF-50-C		50	0.25	1.0	0.6	11.0
SK D35-G	8555	MF 6-GF-50-CT		50	0.16	0.1	0.7	13.0
SK D37-G	8555	MF 3-GF-45-T		45	0.2	0.7	0.5	10.5
SK D37S-G	8555	MF 3-GF-50-T		49	0.2	0.7	0.5	10.5
SK D40-G	8555	MF 3-GF-45-T		42	0.21	0.6	0.5	5.4
SK D40S-G	8555	MF 3-GF-50-T		42	0.25	0.9	0.6	5.6
SK D52-G	8555	MF 3-GF-40-T		40	0.13	1.6	0.6	2.0
SK D250-G	8555	MF 1-GF-350	330		0.09	0.8	0.3	2.9

### Solution examples

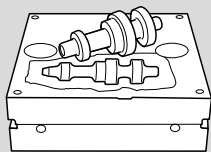

*Forging die*

SK D8-G

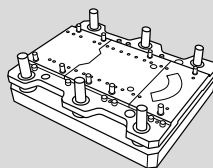

*Stamping die*

SK D12-G

# applications

	Ni	Mo	Ti	W	V	Fe	Co	Type of wear						Page	
								Low stress abrasion	Erosion	Impact	Corrosion	Cavitation	Metal to metal wear		Heat
				3.8	0.6	Bal.									252
				3.5	0.6	Bal.									253
		1.9	0.05	1.6	0.4	Bal.									254
		1.7	0.3			Bal.									255
		1.7	0.25			Bal.									256
		0.5		9.0	0.4	Bal.	3.0	■						■	257
	2.2	2.4		0.3	0.3	Bal.								■	258
		8.0		1.8	1.7	Bal.		■						■	259
	0.3	1.1		0.8	0.9	Bal.	1.7				■			■	260
		2.4				Bal.	14.0				■	■		■	261
	3.0	2.2			0.1	Bal.								■	262
	3.0	2.2				Bal.								■	263
		2.5		2.2	0.6	Bal.								■	264
		2.5		2.4	0.6	Bal.								■	265
	2.7	0.9				Bal.				■				■	266
	2.4					Bal.				■				■	267

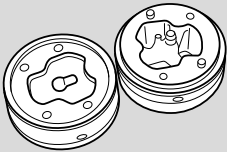

Hot extrusion die

SK D40-G

**SK D8-G**

tool steels

**Classifications**

gas-shielded metal-cored wire

DIN 8555

MF 3-GF-40-T

**Characteristics**

Special alloy designed for the repair and the hard-surfacing of tools working at low and high temperatures. The resistance to thermal shocks, mechanical stresses and adhesive wear is maintained up to 500 – 550 °C.

Microstructure: Martensite

Machinability: Good with metallic carbide tipped tools

Oxy-acetylene cutting: Can be flame cut

Deposit thickness: Depends upon application and procedure used

Shielding gas: Argon 98% + Oxygen 2%

**Field of use**

Cold shear blades, hot punches, hot extrusion dies, mill guides, moulds, camshafts.

**Typical analysis in %**

C	Mn	Si	Cr	W	V	Fe
0.1	1.1	0.4	2.4	3.8	0.6	balance

**Typical mechanical properties**

Hardness as welded: 38 HRC

**Form of delivery and recommended welding parameters**

Wire diameter [mm]	Amperage [A]	Voltage [V]	Stick-out [mm]	Gas flow [L/min]
1.2	200 – 300	25 – 31	20 max.	12 – 15
1.6	250 – 450	25 – 31	20 max.	15 – 18

**Classifications**

Gas-shielded flux-cored wire

DIN 8555

MF 3-GF-45-T

**Characteristics**

Special alloy designed for the repair and the hard-surfacing of tools working at low and high temperatures. The resistance to thermal shocks, mechanical stresses and adhesive wear is maintained up to 500 – 550 °C.

Microstructure: Martensite

Machinability: Good with metallic carbide tipped tools

Oxy-acetylene cutting: Cannot be flame cut

Deposit thickness: Depends upon application and procedure used

Shielding gas: Argon 98 % + Oxygen 2 %

**Field of use**

Cold shear blades, hot punches, hot extrusion dies, mill guides, moulds, camshafts.

**Typical analysis in %**

C	Mn	Si	Cr	W	V	Fe
0.1	1.1	0.5	2.4	3.5	0.6	balance

**Typical mechanical properties**

Hardness as welded: 38 HRC

**Form of delivery and recommended welding parameters**

Wire diameter [mm]	Amperage [A]	Voltage [V]	Stick-out [mm]	Gas flow [L/min]
1.6	250 – 400	25 – 31	20 max.	15 – 18
2.0	275 – 450	25 – 31	20 max.	18 – 20
2.4	300 – 500	25 – 31	20 max.	20 – 22

**SK D11-G**

tool steels

**Classifications**

gas-shielded metal-cored wire

DIN 8555

MF 3-GF-55-T

**Characteristics**

Special tool steel iron base alloy designed to resist metal-to-metal wear at medium temperature.

Microstructure: Martensite

Machinability: Good with cubic Nitride Boron tipped tools

Oxy-acetylene cutting: Cannot be flame cut

Deposit thickness: Depends upon application and procedure used

Shielding gas: Argon 98 % + Oxygen 2 %

**Field of use**

Cutting tools, punshing tools, forming tools, dies, rebuilding of AISI H-12 tool steel.

**Typical analysis in %**

C	Mn	Si	Cr	Mo	W	V	Ti	Fe
0.3	1.2	0.6	5.3	1.9	1.6	0.4	0.05	balance

**Typical mechanical properties**

Hardness as welded: 56 HRC

**Form of delivery and recommended welding parameters**

Wire diameter [mm]	Amperage [A]	Voltage [V]	Stick-out [mm]	Gas flow [L/min]
1.2	200 – 300	25 – 31	20 max.	12 – 15



**Classifications**

gas-shielded metal-cored wire

DIN 8555

MF 3-GF-55-T

**Characteristics**

Metal-cored wire designed for hard-surfacing of tool steel parts.

Microstructure: Martensite

Machinability: Good with cubic Boron Nitride tipped tools

Oxy-acetylene cutting: Cannot be flame cut

Deposit thickness: Depends upon application and procedure used

Shielding gas: Argon 98 % + Oxygen 2 %

**Field of use**

Hot shear blades, hot punches, hot extrusion dies, cutting dies, stamping dies, mill guides, moulds, sheet punching tools, ingot points plier, plastic injection screws, etc.

**Typical analysis in %**

C	Mn	Si	Cr	Mo	Ti	Fe
0.35	1.2	0.3	7.5	1.7	0.3	balance

**Typical mechanical properties**

Hardness as welded: 55 HRC

**Form of delivery and recommended welding parameters**

Wire diameter [mm]	Amperage [A]	Voltage [V]	Stick-out [mm]	Gas flow [L/min]
1.2	200 – 300	25 – 31	20 max.	12 – 15
1.6	250 – 450	25 – 31	20 max.	15 – 18

**SK D12S-G**

tool steels

**Classifications**

Gas-shielded flux-cored wire

DIN 8555

MF 3-GF-55-T

**Characteristics**

Flux-cored wire designed for hard-surfacing of tool steel parts.

Microstructure: Martensite

Machinability: Good with cubic Boron Nitride tipped tools

Oxy-acetylene cutting: Cannot be flame cut

Deposit thickness: Depends upon application and procedure used

Shielding gas: Argon 98 % + Oxygen 2 % or Argon 82 % + CO<sub>2</sub> 18 %**Field of use**

Hot shear blades, hot punches, hot extrusion dies, cutting dies, stamping dies, mill guides, moulds, sheet punching tools, ingot points plier, plastic injection screws.

**Typical analysis in %**

C	Mn	Si	Cr	Mo	Ti	Fe
0.38	1.2	0.5	7.5	1.7	0.25	balance

**Typical mechanical properties**

Hardness as welded: 56 HRC

**Form of delivery and recommended welding parameters**

Wire diameter [mm]	Amperage [A]	Voltage [V]	Stick-out [mm]	Gas flow [L/min]
2.4	275 – 500	25 – 31	20 max.	18 – 20

**Classifications**

gas-shielded metal-cored wire

DIN 8555

MF 3-GF-60-T

**Characteristics**

Metal-cored wire designed to repair and hardface tool steel parts working at high temperature. The high tungsten content allows the hardness to be maintained up to 600 °C.

Microstructure: Martensite

Machinability: Good with cubic Boron Nitride tipped tools

Oxy-acetylene cutting: Cannot be flame cut

Deposit thickness: Depends upon application and procedure used

Shielding gas: Argon 98% + Oxygen 2%

**Field of use**

Hot forging tools and dies.

**Typical analysis in %**

C	Mn	Si	Cr	Mo	Co	W	V	Fe
0.4	0.5	0.4	1.4	0.5	3.0	9.0	0.4	balance

**Typical mechanical properties**

Hardness as welded: 60 HRC

**Form of delivery and recommended welding parameters**

Wire diameter [mm]	Amperage [A]	Voltage [V]	Stick-out [mm]	Gas flow [L/min]
1.2	200 – 300	25 – 31	20 max.	12 – 15
1.6	250 – 450	25 – 31	20 max.	15 – 18

**SK D16-G**

tool steels

**Classifications**

gas-shielded metal-cored wire

DIN 8555

MF 3-GF-50-T

**Characteristics**

Special tool steel Iron base alloy designed to resist metal-to-metal wear at medium temperature.

Microstructure: Martensite

Machinability: Good with cubic Nitride Boron tipped tools

Oxy-acetylene cutting: Cannot be flame cut

Deposit thickness: Depends upon application and procedure used

Shielding gas: Argon 98 % + Oxygen 2 %

**Field of use**

Cutting tools, punching tools, forming tools, dies.

**Typical analysis in %**

C	Mn	Si	Cr	Ni	Mo	W	V	Fe
0.28	0.5	0.4	8.5	2.2	2.4	0.3	0.3	balance

**Typical mechanical properties**

Hardness as welded: 51 HRC

**Form of delivery and recommended welding parameters**

Wire diameter [mm]	Amperage [A]	Voltage [V]	Stick-out [mm]	Gas flow [L/min]
1.6	250 – 450	25 – 31	20 max.	15 – 18

**SK D20-G**

tool steels

**Classifications**

gas-shielded metal-cored wire

DIN 8555

MF 4-GF-60-S

**Characteristics**

Special alloy designed to deposit a molybdenum-alloyed high-speed steel. To avoid cracking, a minimum interpass temperature of 300 °C should be applied.

Microstructure: Precipitated fine carbides in a martensitic matrix

Machinability: Grinding only

Oxy-acetylene cutting: Cannot be flame cut

Deposit thickness: Depends upon application and procedure used

Shielding gas: Argon 98 % + Oxygen 2 %

**Field of use**

Cutting edges of carbon steel tools, cold shear blades, lathe tools, guides, milling cutter, punching, drilling and stamping tools.

**Typical analysis in %**

C	Mn	Si	Cr	Mo	W	V	Fe
1.2	0.4	0.4	4.5	8.0	1.8	1.7	balance

**Typical mechanical properties**

Hardness as welded: 60 HRC

**Form of delivery and recommended welding parameters**

Wire diameter [mm]	Amperage [A]	Voltage [V]	Stick-out [mm]	Gas flow [L/min]
1.2	200 – 300	26 – 30	20 max.	12 – 15
1.6	250 – 450	26 – 30	20 max.	15 – 18

**SK D33-G**

tool steels

**Classifications**

gas-shielded metal-cored wire

DIN 8555

MF 6-GF-50-C

**Characteristics**

Special alloy designed for the repair and the hard-surfacing of extrusion tools.

Microstructure: Martensite

Machinability: By grinding only

Oxy-acetylene cutting: Cannot be flame cut

Deposit thickness: Depends upon application and procedure used

Shielding gas: Argon 98% + Oxygen 2% or Argon 100%

**Field of use**

Gum mixer shell.

**Typical analysis in %**

C	Mn	Si	Cr	Ni	Mo	Co	W	V	Fe
0.25	1.0	0.6	11.0	0.3	1.1	1.7	0.8	0.9	balance

**Typical mechanical properties**

Hardness as welded: 50 HRC

**Form of delivery and recommended welding parameters**

Wire diameter [mm]	Amperage [A]	Voltage [V]	Stick-out [mm]	Gas flow [L/min]
1.6	250 – 450	20 – 31	20 max.	15 – 18

**Classifications**

gas-shielded metal-cored wire

DIN 8555

MF 6-GF-50-CT

**Characteristics**

Special Iron-Chromium-Cobalt-Molybdenum alloy designed to resist metal-to-metal wear, fatigue, oxidation, cavitation and corrosion at high temperature. The typical hardness can be achieved in the first layer.

Microstructure: Martensite + 15% ferrite (in first layer)

Machinability: Good with metallic carbide tipped tools

Oxy-acetylene cutting: Cannot be flame cut

Deposit thickness: Depends upon application and procedure used

Shielding gas: Argon 98% + Oxygen 2% or Argon 100%

**Field of use**

Continuous casting driving rollers, dies, mandrels, blanking punches, forming and punching tools, forging dies, swaging dies, pump elements.

**Typical analysis in %**

C	Mn	Si	Cr	Mo	Co	Fe
0.16	0.1	0.7	13.0	2.4	14.0	balance

**Typical mechanical properties**

Hardness as welded: 50 HRC

**Form of delivery and recommended welding parameters**

<i>D</i> Wire diameter [mm]	<i>A</i> mperage [A]	<i>V</i> oltage [V]	<i>S</i> tick-out [mm]	<i>G</i> as flow [L/min]
1.2	200 – 300	25 – 31	20 max.	12 – 15
1.6	250 – 450	25 – 31	20 max.	15 – 18

**SK D37-G**

tool steels

**Classifications**

gas-shielded metal-cored wire

DIN 8555

MF 3-GF-45-T

**Characteristics**

Special tool steel Iron base alloy designed to refurbish dies in the automobile industry.

Microstructure: Martensite

Machinability: Good

Oxy-acetylene cutting: Cannot be flame cut

Deposit thickness: Depends upon application and procedure used

Shielding gas: Argon 98% + Oxygen 2% or Argon 82% + CO<sub>2</sub> 18%

**Field of use**

Punching tools, forming tools, dies.

**Typical analysis in %**

C	Mn	Si	Cr	Ni	Mo	V	Fe
0.2	0.7	0.5	10.5	3.0	2.2	0.1	balance

**Typical mechanical properties**

Hardness as welded: 45 HRC

**Form of delivery and recommended welding parameters**

Wire diameter [mm]	Amperage [A]	Voltage [V]	Stick-out [mm]	Gas flow [L/min]
1.2	200 – 300	25 – 31	20 max.	12 – 15
1.6	250 – 450	25 – 31	20 max.	15 – 18



**Classifications**

Gas-shielded flux-cored wire

DIN 8555

MF 3-GF-50-T

**Characteristics**

Special tool steel Iron base alloy designed to refurbish forging dies in the automotive industry.

Microstructure: Martensite

Machinability: Good

Oxy-acetylene cutting: Cannot be flame cut

Deposit thickness: Depends upon application and procedure used

Shielding gas: Argon + CO<sub>2</sub> 18%

**Field of use**

Punching tools, forming tools, dies.

**Typical analysis in %**

C	Mn	Si	Cr	Ni	Mo	Fe
0.2	0.7	0.5	10.5	3.0	2.2	balance

**Typical mechanical properties**

Hardness as welded: 49 HRC

**Form of delivery and recommended welding parameters**

Wire diameter [mm]	Amperage [A]	Voltage [V]	Stick-out [mm]	Gas flow [L/min]
2.0	250 – 400	27 – 32	20 max.	15 – 18

**SK D40-G**

tool steels

**Classifications**

gas-shielded metal-cored wire

DIN 8555

MF 3-GF-45-T

**Characteristics**

Special tool steel Iron base alloy designed to refurbish dies in automobile industry.

Microstructure: Martensite

Machinability: Good

Oxy-acetylene cutting: Cannot be flame cut

Deposit thickness: Depends upon application and procedure used

Shielding gas: Argon 98% + Oxygen or Argon 82% + CO<sub>2</sub> 18%**Field of use**

Punching tools, forming tools, dies.

**Typical analysis in %**

C	Mn	Si	Cr	Mo	W	V	Fe
0.21	0.6	0.5	5.4	2.5	2.2	0.6	balance

**Typical mechanical properties**

Hardness as welded: 42 HRC

**Form of delivery and recommended welding parameters**

Wire diameter [mm]	Amperage [A]	Voltage [V]	Stick-out [mm]	Gas flow [L/min]
1.2	200 – 300	25 – 31	20 max.	12 – 15

**Classifications**

Gas-shielded flux-cored wire

DIN 8555

MF 3-GF-50-T

**Characteristics**

Special tool steel Iron base alloy designed to refurbish dies in the automobile industry.

Microstructure: Martensite

Machinability: Good with metallic carbide tipped tools

Oxy-acetylene cutting: Cannot be flame cut

Deposit thickness: Depends upon application and procedure used

Shielding gas: Argon 82%+ CO<sub>2</sub> 18%**Field of use**

Punching tools, forming tools, dies.

**Typical analysis in %**

C	Mn	Si	Cr	Mo	W	V	Fe
0.25	0.9	0.6	5.6	2.5	2.4	0.6	balance

**Typical mechanical properties**

Hardness as welded: 42 HRC

**Form of delivery and recommended welding parameters**

Wire diameter [mm]	Amperage [A]	Voltage [V]	Stick-out [mm]	Gas flow [L/min]
1.6	250 – 400	25 – 31	20 max.	15 – 18
2.0	275 – 450	25 – 31	20 max.	18 – 20
2.4	300 – 500	25 – 31	20 max.	20 – 22

**SK D52-G**

tool steels

**Classifications**

gas-shielded metal-cored wire

DIN 8555

MF 3-GF-40-T

**Characteristics**

Special tool steel Iron base alloy designed to overlay and repair forging and hot-working die steels.

Microstructure: Martensite

Machinability: Good

Oxy-acetylene cutting: Cannot be flame cut

Deposit thickness: Depends upon application and procedure used

Shielding gas: Argon 98 % + Oxygen 2 % or Argon 82 % + CO<sub>2</sub> 18 %

**Field of use**

Die shanks, sow blocks, rams and forging hammer bases.

**Typical analysis in %**

C	Mn	Si	Cr	Ni	Mo	Fe
0.13	1.6	0.6	2.0	2.7	0.9	balance

**Typical mechanical properties**

Hardness as welded: 40 HRC

**Form of delivery and recommended welding parameters**

Wire diameter [mm]	Amperage [A]	Voltage [V]	Stick-out [mm]	Gas flow [L/min]
1.6	250 – 400	26 – 31	20 max.	18 – 20

**Classifications**

gas-shielded metal-cored wire

DIN 8555

MF 1-GF-350

**Characteristics**

Special alloy suitable for repair of tool steel parts working at high temperatures. The deposit is particularly resistant against cracks propagation.

Microstructure: Bainite + Martensite

Machinability: Good

Oxy-acetylene cutting: Possible

Deposit thickness: No restriction

Shielding gas: Argon 82 % + Oxygen 18 %

**Field of use**

Large casting parts, forging matrix, etc.

**Typical analysis in %**

C	Mn	Si	Cr	Ni	Fe
0.09	0.8	0.3	2.9	2.4	balance

**Typical mechanical properties**

Hardness as welded: 330 HB

**Form of delivery and recommended welding parameters**

Wire diameter [mm]	Amperage [A]	Voltage [V]	Stick-out [mm]	Gas flow [L/min]
1.6	200 – 280	26 – 31	20 max.	15 – 20

## Gas-shielded cored wire for repair, anti-wear and anti-corrosion

### 5. Cobalt alloys

Product name	DIN		HB	HRC	C	Mn	Si	Cr
SK STELKAY 1-G	8555	MF 20-GF-55-CTZ		54	2,3	0,8	1,6	26,5
SK STELKAY 6-G	8555	MF 20-GF-40-CTZ		40	0,95	0,8	1,4	30,0
SK STELKAY 6 A-G	8555	MF 20-GF-45-CTZ		43	1,35	0,8	1,5	27,0
SK STELKAY 6 L-G	8555	MF 20-GF-300-CTZ		35	0,8	0,8	1,0	28,0
SK STELKAY 6 T-G	8555	MF 20-GF-40-CTZ		40	0,95	0,8	0,8	31,5
SK STELKAY 12-G	8555	MF 20-GF-50-CSTZ		40	1,15	0,9	1,8	28,8
SK STELKAY 21-G	8555	MF 20-GF-300-CTZ		32	0,27	1,0	1,2	28,0
SK STELKAY 21 L-G	8555	MF 20-GF-300-CTZ		28	0,18	1,0	1,2	28,0
SK STELKAY 21 T-G	8555	MF 20-GF-300-CTZ		32	0,27	1,0	1,2	28,0
SK STELKAY 25-G	8555	MF 20-GF-200-STZ	195		0,01	0,8	0,4	20,2

#### Solution examples

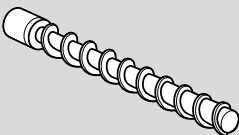
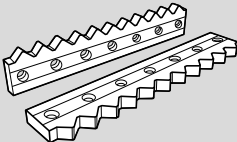
	
<i>Extrusion screw</i>	<i>Hot share blade</i>
SK STELKAY 1-G	SK STELKAY 6 A-G

# applications

	Ni	Mo	Ti	W	Fe	Co	Type of wear							Page	
							Low stress abrasion	High stress abrasion	Erosion	Impact	Corrosion	Cavitation	Metal to metal wear		Heat
				11,5	3,0	Bal.	■						■	■	270
				4,2	3,0	Bal.					■	■	■	■	271
				3,5	3,0	Bal.					■	■	■	■	272
				4,2	3,0	Bal.					■	■	■	■	273
				5,0	3,0	Bal.					■	■	■	■	274
				6,5	3,0	Bal.	■						■	■	275
	2,4	5,0			3,5	Bal.				■	■	■	■	■	276
	2,5	5,0			3,5	Bal.				■	■	■	■	■	277
	2,4	5,0			3,5	Bal.				■	■	■	■	■	278
	10,0			13,0	3,5	Bal.				■	■	■	■	■	279

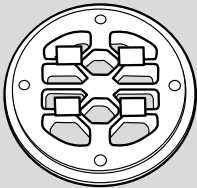

Extrusion die

SK STELKAY 21-G

**SK STELKAY 1-G**

Cobalt alloys

**Classifications** gas-shielded metal-cored wire

DIN 8555 ASME IIC SFA 5.21

MF 20-GF-55-CTZ ERC CoCr-C

**Characteristics**

Cobalt base alloy providing excellent resistance to metal-to-metal wear, oxidation and high stress abrasion wear, in corrosive environments at high temperature. For reduced levels of dilution and an improved weldability, we recommend using a pulsed MIG welding mode.

Microstructure: Cr and W carbides in an austenitic matrix

Machinability: Grinding only

Oxy-acetylene cutting: Cannot be flame cut

Deposit thickness: Depends upon application and procedure used

Shielding gas: Argon 98 % + Oxygen 2 % or Argon 100 %

**Field of use**

Mill guides, palm nut oil extruder, plastic extrusion screws, mixer blades, scrapers, rubber mixer.

**Typical analysis in %**

C	Mn	Si	Cr	Co	W	Fe
2.3	0.8	1.6	26.5	balance	11.5	3.0

**Typical mechanical properties**

Hardness as welded: 54 HRC

**Form of delivery and recommended welding parameters**

Wire diameter [mm]	Amperage [A]	Voltage [V]	Stick-out [mm]	Gas flow [L/min]
1.2	110 – 180	20 – 31	20 max.	12 – 15
1.6	150 – 250	20 – 31	20 max.	15 – 18



# SK STELKAY 6-G

Cobalt alloys

**Classifications** gas-shielded metal-cored wire

DIN 8555

ASME IIC SFA 5.21

MF 20-GF-40-CTZ

ERC CoCr-A

## Characteristics

Cobalt base alloy providing excellent resistance to metal-to-metal wear, oxidation, thermal cycling and impact in corrosive environments at high temperature. For reduced levels of dilution and an improved weldability, we recommend using a pulsed MIG welding mode.

Microstructure: Cr and W carbides in an austenitic matrix

Machinability: Good with metallic carbide tipped tools

Oxy-acetylene cutting: Cannot be flame cut

Deposit thickness: Depends upon application and procedure used

Shielding gas: Argon 98 % + Oxygen 2 % or Argon 100 %

Welding flux (for dia. 2.4): Record SA

## Field of use

Valves, valve seats in motor vehicles, hot shear blades, extruder screws, clack valves and seats, dies, punches.

## Typical analysis in %

C	Mn	Si	Cr	Co	W	Fe
0.95	0.8	1.4	30.0	balance	4.2	3.0

## Typical mechanical properties

Hardness as welded: 40 HRC

## Form of delivery and recommended welding parameters

Wire diameter [mm]	Amperage [A]	Voltage [V]	Stick-out [mm]	Gas flow [L/min]
1.2	110 – 180	20 – 31	20 max.	12 – 15
1.6	150 – 250	20 – 31	20 max.	15 – 18
2.4	300 – 400	20 – 31	20 max.	18 – 20

**SK STELKAY 6 A-G**

Cobalt alloys

**Classifications** gas-shielded metal-cored wire

DIN 8555 ASME IIC SFA 5.21

MF 20-GF-45-CTZ ERC CoCr-A

**Characteristics**

Cobalt base alloy providing excellent resistance to metal-to-metal wear, oxidation, thermal cycling and impact in corrosive environments at high temperature. For reduced levels of dilution and an improved weldability, we recommend using a pulsed MIG welding mode.

Microstructure: Cr and W carbides in an austenitic matrix

Machinability: Good with metallic carbide tipped tools

Oxy-acetylene cutting: Cannot be flame cut

Deposit thickness: Depends upon application and procedure used

Shielding gas: Argon 98 % + Oxygen 2 % or Argon 100 %

**Field of use**

Valves, valve seats in motor vehicles, hot shear blades, extruder screws, clack valves and seats, dies, punches.

**Typical analysis in %**

C	Mn	Si	Cr	Co	W	Fe
1.35	0.8	1.5	27.0	balance	3.5	3.0

**Typical mechanical properties**

Hardness as welded: 43 HRC

**Form of delivery and recommended welding parameters**

Wire diameter [mm]	Amperage [A]	Voltage [V]	Stick-out [mm]	Gas flow [L/min]
1.2	110 – 180	20 – 31	20 max.	12 – 15
1.6	150 – 250	20 – 31	20 max.	15 – 18

# SK STELKAY 6 L-G

Cobalt alloys

## Classifications

gas-shielded metal-cored wire

DIN 8555

MF 20-GF-300-CTZ

## Characteristics

Cobalt base alloy providing excellent resistance to metal-to-metal wear, oxidation, thermal cycling and impact in corrosive environments at high temperature. For reduced levels of dilution and an improved weldability, we recommend using a pulsed MIG welding mode.

Microstructure: Cr and W carbides in an austenitic matrix

Machinability: Good with metallic carbide tipped tools

Oxy-acetylene cutting: Cannot be flame cut

Deposit thickness: Depends upon application and procedure used

Shielding gas: Argon 98 % + Oxygen 2 % or Argon 100 %

## Field of use

Valves, valve seats in motor vehicles, hot shear blades, extruder screws, clack valves and seats, dies, punches.

## Typical analysis in %

C	Mn	Si	Cr	Co	W	Fe
0.8	0.8	1.0	28.0	balance	4.2	3.0

## Typical mechanical properties

Hardness as welded: 35 HRC

## Form of delivery and recommended welding parameters

Wire diameter [mm]	Amperage [A]	Voltage [V]	Stick-out [mm]	Gas flow [L/min]
1.6	150 – 250	20 – 31	20 max.	15 – 18

**SK STELKAY 6 T-G**

Cobalt alloys

**Classifications**

gas-shielded metal-cored wire

DIN 8555

MF 20-GF-40-CTZ

**Characteristics**

Cobalt base wire designed to be used with the GTAW process (TIG). Alloy providing excellent resistance to metal-to-metal wear, oxidation, thermal cycling and impact in corrosive environments at high temperature.

Microstructure: Cr and W carbides in an austenitic matrix

Machinability: Good with metallic carbide tipped tools

Oxy-acetylene cutting: Cannot be flame cut

Deposit thickness: Depends upon application and procedure used

Shielding gas: Argon 100 %

**Field of use**

Valves, valve seats in motor vehicles, hot shear blades, extruder screws, clack valves and seats, dies, punches.

**Typical analysis in %**

C	Mn	Si	Cr	Co	W	Fe
0.95	0.8	0.8	31.5	balance	5.0	3.0

**Typical mechanical properties**

Hardness as welded: 40 HRC

**Form of delivery and recommended welding parameters**

Wire diameter [mm]	Amperage [A]	Voltage [V]	Stick-out [mm]	Gas flow [L/min]
1.2	110 – 180	20 – 31	20 max.	12 – 15
1.6	150 – 250	20 – 31	20 max.	15 – 18

**Classifications**

gas-shielded metal-cored wire

DIN 8555

EN 14700

AWS A5.21

MF 20-GF-50-CSTZ

TZ Co3

ER CoCr-B

**Characteristics**

Cobalt-base alloy providing excellent resistance to metal-to-metal wear, thermal cycling and oxidation in corrosive environments at high temperatures. Suitable for GMAW or SAW processes. For reduced levels of dilution and an improved weldability, we recommend using a pulsed MIG welding mode.

Microstructure: Chromium and tungsten carbides in an austenitic matrix

Machinability: Good with cubic boron nitride tools

Oxy-acetylene cutting: Cannot be flame cut

Deposit thickness: Depends on application and procedure

Shielding gas: Argon 98 % + oxygen 2 %

Welding flux: Record SA

**Field of use**

Camshafts, wood cutting tools, plastic extrusion screws, paper- and plastic- cutting tools and saw blades.

**Typical analysis in %**

C	Mn	Si	Cr	W	Fe	Co
1.15	0.9	1.8	28.8	6.5	3.0	balance

**Typical mechanical properties**

Hardness as welded: 48 HRC

**Form of delivery and recommended welding parameters**

Wire diameter [mm]	Amperage [A]	Voltage [V]	Stick-out [mm]	Gas flow [L/min]
1.2	110 – 180	20 – 31	20 max.	12 – 15
1.6	150 – 250	20 – 31	20 max.	15 – 18
2.0*	200 – 350	20 – 31	20 max.	15 – 18
2.4*	300 – 400	20 – 31	20 max.	18 – 20

\* available on request

**SK STELKAY 21-G**

Cobalt alloys

**Classifications** gas-shielded metal-cored wire

DIN 8555 ASME IIC SFA 5.21

MF 20-GF-300-CTZ ERC CoCr-E

**Characteristics**

Cobalt base alloy providing excellent resistance to metal-to-metal wear, thermal shocks, oxidation in corrosive environments at high temperature. For reduced levels of dilution and an improved weldability, we recommend using a pulsed MIG welding mode.

Microstructure:	Cr and Mo carbides in an austenitic matrix
Machinability:	Good
Oxy-acetylene cutting:	Cannot be flame cut
Deposit thickness:	Depends upon application and procedure used
Shielding gas:	Argon 98% + Oxygen 2% or Argon 100%
Welding flux (for dia. 2.4):	Record SA

**Field of use**

Extrusion dies, hot working tools, turbine injectors, valve seats, ingot tong bits.

**Typical analysis in %**

C	Mn	Si	Cr	Ni	Mo	Co	Fe
0.27	1.0	1.2	28.0	2.4	5.0	balance	3.5

**Typical mechanical properties**

Hardness as welded: 32 HRC

**Form of delivery and recommended welding parameters**

Wire diameter [mm]	Amperage [A]	Voltage [V]	Stick-out [mm]	Gas flow [L/min]
1.2	110 – 180	20 – 31	20 max.	12 – 15
1.6	150 – 250	20 – 31	20 max.	15 – 18
2.4	300 – 400	20 – 31	20 max.	18 – 20

# SK STELKAY 21 L-G

Cobalt alloys

**Classifications** gas-shielded metal-cored wire

DIN 8555

ASME IIC SFA 5.21

MF 20-GF-300-CTZ

ERC CoCr-E

## Characteristics

Cobalt base alloy providing excellent resistance to metal-to-metal wear, thermal shocks, oxidation in corrosive environments at high temperature. For reduced levels of dilution and an improved weldability, we recommend using a pulsed MIG welding mode.

Microstructure: Cr and Mo carbides in an austenitic matrix

Machinability: Good

Oxy-acetylene cutting: Cannot be flame cut

Deposit thickness: Depends upon application and procedure used

Shielding gas: Argon 98 % + Oxygen 2 % or Argon 100 %

## Field of use

Extrusion dies, hot working tools, turbine injectors, valve seats, ingot tong bits.

## Typical analysis in %

C	Mn	Si	Cr	Ni	Mo	Co	Fe
0.18	1.0	1.2	28.0	2.5	5.0	balance	3.5

## Typical mechanical properties

Hardness as welded: 28 HRC

## Form of delivery and recommended welding parameters

Wire diameter [mm]	Amperage [A]	Voltage [V]	Stick-out [mm]	Gas flow [L/min]
1.2	110 – 180	20 – 31	20 max.	12 – 15
1.6	150 – 250	20 – 31	20 max.	15 – 18

**SK STELKAY 21 T-G**

Cobalt alloys

**Classifications** gas-shielded metal-cored wire

DIN 8555 ASME IIC SFA 5.21

MF 20-GF-300-CTZ ERC CoCr-E

**Characteristics**

Cobalt base wire designed to be used with the GTAW process (TIG). Alloy providing excellent resistance to metal-to-metal wear, thermal shocks, oxidation in corrosive environments at high temperature.

Microstructure: Cr and Mo carbides in an austenitic matrix

Machinability: Good

Oxy-acetylene cutting: Cannot be flame cut

Deposit thickness: Depends upon application and procedure used

Shielding gas: Argon 100 %

**Field of use**

Extrusion dies, hot working tools, turbine injectors, valve seats, ingot tong bits.

**Typical analysis in %**

C	Mn	Si	Cr	Ni	Mo	Co	Fe
0.27	1.0	1.2	28.0	2.4	5.0	balance	3.5

**Typical mechanical properties**

Hardness as welded: 32 HRC

**Form of delivery and recommended welding parameters**

Wire diameter [mm]	Amperage [A]	Voltage [V]	Stick-out [mm]	Gas flow [L/min]
1.6	150 – 250	20 – 31	20 max.	15 – 18



**Classifications**

gas-shielded metal-cored wire

DIN 8555

MF 20-GF-200-STZ

**Characteristics**

Cobalt base alloy providing excellent resistance to metal-to-metal wear, thermal shocks, oxidation in corrosive environments at high temperature. For reduced levels of dilution and an improved weldability, we recommend using a pulsed MIG welding mode.

Microstructure: Solution of the austenitic type

Machinability: Good

Oxy-acetylene cutting: Cannot be flame cut

Deposit thickness: Depends upon application and procedure used

Shielding gas: Argon 98 % + Oxygen 2 % or Argon 100 %

**Field of use**

Hot working tools, forging hammers.

**Typical analysis in %**

C	Mn	Si	Cr	Ni	Co	W	Fe
0.01	0.8	0.4	20.2	10.0	balance	13.0	3.5

**Typical mechanical properties**

Hardness as welded: 195 HB

**Form of delivery and recommended welding parameters**

Wire diameter [mm]	Amperage [A]	Voltage [V]	Stick-out [mm]	Gas flow [L/min]
1.2	110 – 180	20 – 31	20 max.	12 – 15
1.6	150 – 250	20 – 31	20 max.	15 – 18

# Gas-shielded cored wire for repair, anti-wear and anti-corrosion

## 6. Nickel alloys

Product name	DIN		HB	HRC	C	Mn	Si	Cr	
SK 900 Ni-G	8555	MF 22-GF-45-G		46	1,7	0,1	0,1		
SK 900 Ni RTC-G	8555	MF 20-GF-200-STZ			2,8	0,1	0,1		
SK FNM-G			145		0,2	12,0	0,4		
SK FNM4-G	8573	(ca) MF NiFe-2-S	140		0,25	3,5	0,7		
SK TOOL ALLOY C-G	8555	MF 23-GF-200-CKZ	195		0,05	1,0	0,2	16,0	
SK TOOL ALLOY Co-G	8555	MF 23-GF-200-CKZ	220		0,03	1,3	0,7	16,0	
SK U 520 Co-G	8555	MF 22-GF-200-TZ	190		0,02	0,5	0,3	19,0	
SK U 521-G	8555	MF 23-GF-200-TZ	200		0,01		0,3	18,5	
UTP AF 068 HH					0,03	3,0	0,4	20,0	

### Solution examples

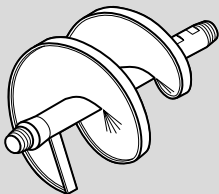

*Screw-conveyor*

SK 900 Ni RTC-G

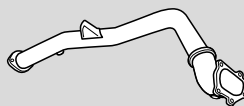

*Bellmouth flange*

SK FNM-G

# applications

	Ni	Mo	Ti	W	B	Fe	Co	Al	Type of wear						Page	
									High stress abrasion	Impact	Corrosion	Cavitation	Metal to metal wear	Heat		
	Bal.			41,5	0,8	1,1				■		■				282
	Bal.			42,0	0,7	1,1				■		■				283
	Bal.					48,0					■					284
	Bal.					30,0					■					285
	Bal.	16,0		4,0		7,0						■		■	■	286
	Bal.	16,0		4,0		3,0	2,5					■		■	■	287
	Bal.		2,7			2,0	18,0	1,4				■		■	■	288
	Bal.	4,5	3,5			1,8	12,5	1,0				■		■	■	289
	Bal.					1,4						■			■	290

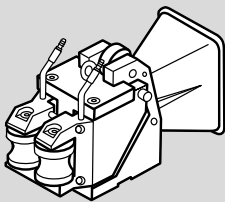

*Rolling entry guide*

SK TOOL ALLOY C-G

**SK 900 Ni-G**

nickel alloys

**Classifications**

gas-shielded metal-cored wire

DIN 8555

MF 22-GF-45-G

**Characteristics**

Hardfacing cored wire containing about 45 % Tungsten carbide particles incorporated in a NiB matrix. This composition gives the best possible combination of toughness and abrasion resistance, also in corrosive conditions.

Microstructure: Tungsten carbides into an austenitic matrix

Machinability: Grinding only

Oxy-acetylene cutting: Not possible

Deposit thickness: 6 mm in 2 layers maximum

Shielding gas: Argon 98 % + Oxygen 2 %

**Field of use**

Wheel excavator bucket teeth, brick and clay mill augers, wood chipper spout and bed knives in the paper industry and crusher rollers, dredging wear parts, etc.

**Typical analysis in %**

C	Mn	Si	Ni	W	B	Fe
1.7	0.1	0.1	balance	41.5	0.8	1.1

**Typical mechanical properties**

Hardness as welded: 46 HRC

**Form of delivery and recommended welding parameters**

Wire diameter [mm]	Amperage [A]	Voltage [V]	Stick-out [mm]	Gas flow [L/min]
1.6	170 – 220	19 – 23	20 max.	12 – 15

# SK 900 Ni RTC-G

nickel alloys

## Classifications

gas-shielded metal-cored wire

DIN 8555

EN 14700

MF 22-GF-45-G

T Ni20

## Characteristics

Hardfacing cored wire containing about 45% special tungsten carbide particles incorporated into a NiB matrix. Thanks to the high degree of preservation of the tungsten carbides in the deposit, this wire offers an outstanding resistance to abrasive wear, even in corrosive environments.

Microstructure: Tungsten carbides in an austenitic matrix

Machinability: Grinding only

Oxy-acetylene cutting: Not possible

Deposit thickness: 6 mm in 2 layers maximum

Shielding gas: Argon 98% + oxygen 2%

## Field of use

Wheel excavator bucket teeth, brick and clay mill augers, wood chipper spouts, bed knives in the paper industry, crusher rollers and dredging wear parts.

## Typical analysis in %

C	Mn	Si	Ni	W	B	Fe
2.8	0.1	0.1	balance	42.0	0.7	1.1

## Typical mechanical properties

Hardness as welded: 44 HRC

## Form of delivery and recommended welding parameters

Wire diameter [mm]	Amperage [A]	Voltage [V]	Stick-out [mm]	Gas flow [L/min]
1.6 mm	170 – 220	19 – 23	20 max.	12 – 15

**SK FNM-G**

nickel alloys

**Classifications**

gas-shielded metal-cored wire

**Characteristics**

FeNi alloy with 12% Manganese designed for joining and surfacing of cast iron pieces. Can also be used for dissimilar welding between cast iron and steel.

Microstructure: Austenitic

Machinability: Good

Oxy-acetylene cutting: Cannot be flame cut

Deposit thickness: Depends upon application and procedure used

Shielding gas: Argon 98% + Oxygen 2% or Argon 100% or  
Argon 82% + CO<sub>2</sub> 18%

**Field of use**

Repair and joining of cast iron parts, joining of steel flanges onto cast iron pipes.

**Typical analysis in %**

C	Mn	Si	Ni	Fe
0.2	12.0	0.4	balance	48.0

**Typical mechanical properties**

Hardness as welded: 145 HB

**Form of delivery and recommended welding parameters**

Wire diameter [mm]	Amperage [A]	Voltage [V]	Stick-out [mm]	Gas flow [L/min]
1.2	110 – 180	20 – 31	20 max.	12 – 15
1.6	150 – 250	20 – 31	20 max.	12 – 15

**SK FNM4-G**

nickel alloys

**Classifications**

gas-shielded metal-cored wire

DIN 8573

(ca) MF NiFe-2-S

**Characteristics**

FeNi alloy with 4 % Manganese designed for joining and surfacing of cast iron pieces. Can also be used for dissimilar welding between cast iron and steel.

Microstructure: Austenite

Machinability: Good

Oxy-acetylene cutting: Cannot be flame cut

Deposit thickness: Depends upon application and procedure used

Shielding gas: Argon 98 % + Oxygen 2 % or Argon 100 % or  
Argon 82 % + CO<sub>2</sub> 18 %

**Field of use**

Repair work on cast iron components.

**Typical analysis in %**

C	Mn	Si	Ni	Fe
0.25	3.5	0.7	balance	30.0

**Typical mechanical properties**

Hardness as welded: 140 HB

**Form of delivery and recommended welding parameters**

Wire diameter [mm]	Amperage [A]	Voltage [V]	Stick-out [mm]	Gas flow [L/min]
1.2	110 – 180	20 – 31	20 max.	12 – 15

**SK TOOL ALLOY C-G**

nickel alloys

**Classifications**

gas-shielded metal-cored wire

DIN 8555

MF 23-GF-200-CKZ

**Characteristics**

NiCrMo alloy designed for hard-surfacing of parts subject to oxidation, corrosion and mechanical stresses at high temperature (1.100 °C). For reduced levels of dilution and an improved weldability, we recommend using a pulsed MIG welding mode.

Microstructure: Solution of the austenitic type

Machinability: Good

Oxy-acetylene cutting: Cannot be flame cut

Deposit thickness: Depends upon application and procedure used

Shielding gas: Argon 98 % + Oxygen 2 % or Argon 82 % + CO<sub>2</sub> 18 %

**Field of use**

Hot shear blades, pits points, mill guides, drawing guides, hot extrusion dies, blast furnace bell seats.

**Typical analysis in %**

C	Mn	Si	Cr	Ni	Mo	W	Fe
0.05	1.0	0.2	16.0	balance	16.0	4.0	7.0

**Typical mechanical properties**

Hardness as welded: 195 HB

**Form of delivery and recommended welding parameters**

Wire diameter [mm]	Amperage [A]	Voltage [V]	Stick-out [mm]	Gas flow [L/min]
1.2	110 – 180	17 – 32	20 max.	12 – 15
1.6	100 – 250	17 – 32	20 max.	15 – 18
2.4	200 – 450	20 – 31	20 max.	18 – 20



# SK TOOL ALLOY Co-G

nickel alloys

## Classifications

gas-shielded metal-cored wire

DIN 8555

MF 23-GF-200-CKZ

## Characteristics

NiCrMo alloy with addition of Cobalt designed for hard-surfacing of parts subject to oxidation, corrosion and mechanical stresses at high temperature (1.100 °C). For reduced levels of dilution and an improved weldability, we recommend using a pulsed MIG welding mode.

Microstructure: Solution of the austenitic type

Machinability: Good with metallic carbide tipped tools

Oxy-acetylene cutting: Cannot be flame cut

Deposit thickness: Depends upon application and procedure used

Shielding gas: Argon 98 % + Oxygen 2 % or Argon 82 % + CO<sub>2</sub> 18 %

## Field of use

Punches for extrusion of steel pipes, hot working tools.

## Typical analysis in %

C	Mn	Si	Cr	Ni	Mo	Co	W	Fe
0.03	1.3	0.7	16.0	balance	16.0	2.5	4.0	3.0

## Typical mechanical properties

Hardness as welded: 220 HB

## Form of delivery and recommended welding parameters

Wire diameter [mm]	Amperage [A]	Voltage [V]	Stick-out [mm]	Gas flow [L/min]
1.6	150 – 250	20 – 31	20 max.	15 – 18
2.4	200 – 450	20 – 31	20 max.	18 – 20

**SK U 520 Co-G**

nickel alloys

**Classifications**

gas-shielded metal-cored wire

DIN 8555

MF 22-GF-200-TZ

**Characteristics**

Nickel-base super-alloy with high percentage of Cobalt providing the most powerful strengthening effect at high temperature due to the precipitation of Ni<sub>3</sub> (AlTi) phase.

Microstructure: Solid solution matrix containing carbides and Intermetallic precipitated Ni<sub>3</sub> (AlTi)

Machinability: Good with metallic carbide tipped tools

Oxy-acetylene cutting: Cannot be flame cut

Deposit thickness: Depends upon application and procedure used

Shielding gas: Argon 98 % + Oxygen 2 % or Argon 100 %

**Field of use**

Rebuilding of GFM forging hammers.

**Typical analysis in %**

C	Mn	Si	Cr	Ni	Co	Ti	Al	Fe
0.02	0.5	0.3	19.0	balance	18.0	2.7	1.4	2.0

**Typical mechanical properties**

Hardness as welded: 190 HB

**Form of delivery and recommended welding parameters**

Wire diameter [mm]	Amperage [A]	Voltage [V]	Stick-out [mm]	Gas flow [L/min]
1.6	150 – 250	20 – 31	20 max.	15 – 18
2.4	300 – 400	20 – 31	20 max.	15 – 20

**Classifications**

gas-shielded metal-cored wire

DIN 8555

MF 23-GF-200-TZ

**Characteristics**

Nickel-base super-alloy with addition of Cobalt providing the most powerful strengthening effect at high temperature due to the precipitation of Ni<sub>3</sub> (AlTi) phase. Enhanced weldability.

Microstructure: Solid solution with intermetallic precipitates Ni<sub>3</sub> (AlTi)

Machinability: Good with metallic carbide tipped tools

Oxy-acetylene cutting: Cannot be flame cut

Deposit thickness: Depends upon application and procedure used

Shielding gas: Argon 98 % + Oxygen 2 %

Liner: A Teflon liner is advised

**Field of use**

Rebuilding of forging hammers.

**Typical analysis in %**

C	Si	Cr	Ni	Mo	Co	Ti	Al	Fe
0.01	0.3	18.5	balance	4.5	12.5	3.5	1.0	1.8

**Typical mechanical properties**

Hardness as welded: 200 HB

**Form of delivery and recommended welding parameters**

Wire diameter [mm]	Amperage [A]	Voltage [V]	Stick-out [mm]	Gas flow [L/min]
1.2	150 – 250	27 – 30	20 max.	15 – 20
1.6	200 – 300	27 – 30	20 max.	15 – 20

## UTP AF 068 HH

nickel alloys

## Classifications

nickel-base flux-cored wire

EN ISO 12153	AWS A5.34	Material-No.
T Ni 6082 RM 3	E NiCr 3 T0-4	2.4648

## Characteristics

UTP AF 068HH is a nickel-base flux-cored wire (NiCr) for joining and surfacing of nickel alloys of the same or similar nature, for heterogeneous joints with C- and CrNi-steels as well as claddings on C-steels. Typical applications are high-temperature components.

2.4816	NiCr15Fe	UNS N06600	Alloy 600
2.4817	LC NiCr15Fe	UNS N01665	Alloy 600 LC
1.4583*	X10CrNiMoNb 18 12		
1.4876	X10NiCrAlTi 32 21		Alloy 800
1.4859	GX10NiCrNb 32 20		
1.0562*	StE 355		

\*Dissimilar joints with nickel-alloys

UTP AF 068HH is characterised by its tough weld metal and an excellent hot cracking resistance. It is especially suited for service temperatures up to 900 °C in long-term use.

UTP AF 068HH has outstanding welding characteristics with a regular and fine drop transfer. The seam is finely rippled, the transition from weld seam to base material is regular and free of notches. A wide range of welding parameters allows an application on different wall thicknesses.

## Typical analysis in %

C	Si	Mn	P	S	Cr	Ni	Nb	Fe
0.03	0.4	3.0	0.007	0.005	20.0	balance	2.4	1.4

## Mechanical properties of the weld metal

Yield strength $R_{p0.2}$	Tensile strength $R_m$	Elongation $A$	Impact toughness $K_v$
MPa	MPa	%	J [RT]
400	650	39	70

## Welding instructions

Clean weld area thoroughly. Welding torch should be held slightly inclined, using pulling technique.

## Welding positions

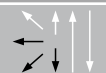

Current type: DC (+)  
Shielding gas: M 21 (EN ISO 14175)

## Approvals

TÜV (Nr.10209)

## Form of delivery and recommended welding parameters

Wire diameter [mm]	Amperage [A]	Voltage [V]
1.2	170 – 210	26 – 32



## Gas-shielded cored wire for repair, anti-wear and anti-corrosion

### 7. Stainless steels

Product name	DIN		HB	HRC	C	Mn	Si	Cr
SK 307-G	8555	MF 8-GF-150-KP	155		0.1	7.1	0.8	17.9
SK 356-G	8555	MF 4-GF-50-ST		47	0.7	1.2	0.9	12.0
SK 402-G	8555	MF 8-GF-150-KP	170		0.1	6.6	0.6	17.1
SK 410 C-G	8555	MF 5-GF-40-C		40	0.08	0.7	0.4	13.0
SK 420 Mo-G	8555	MF 6-GF-55-C		54	0.24	1.0	0.4	12.0
SK 430-G	8555	MF 5-GF-200-C	190		0.06	0.8	0.6	17.8
SK 430 Mo-G			260		0.25	1.0	0.6	19.0
SK 519-G	EN 12073	T 20 25 5 Cu L M M 1			0.02	2.8	0.5	20.5
SK 741-G	8555	MF 5-GF-40-C		41	0.06	0.5	0.6	13.0
SK 768-G	8555	MF 5-GF-350-C		34	0.02	0.3	0.3	14.5
SK ANTINIT DUR 290	8555	MF 9-GF-250-CT	250		0.06	1.9	5.6	17.0
SK ANTINIT DUR 500	8555	MF 9-GF-45-CT		43	0.07	4.3	4.5	17.5

#### Solution examples

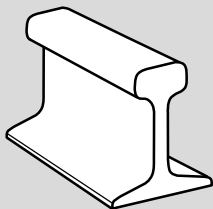

*Rail*

SK 307-G

# applications

	Ni	Mo	Nb	Ti	W	V	Fe	Cu	Type of wear						Page
									Low stress abrasion	Impact	Corrosion	Cavitation	Metal to metal wear	Heat	
	8.5						Bal.	0.2			■		■		294
	0.7	3.8			0.9	2.0	Bal.		■	■			■		295
	7.8						Bal.			■					296
							Bal.				■		■		297
		0.7					Bal.				■		■		298
				0.2			Bal.				■				299
		0.9					Bal.				■				300
	24.2	5.0	Other: N = 0.12				Bal.	1.1		■	■				301
	5.5	0.8					Bal.				■		■		302
	6.3	2.5					Bal.				■		■		303
	8.3						Bal.				■	■	■	■	304
	8.0	5.4	1.0				Bal.				■	■	■	■	305

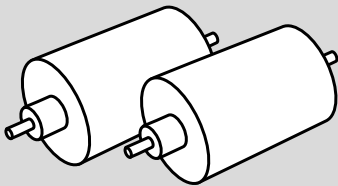

*Small-diameter continuous casting roller*

SK 741-G – SK 768-G

**SK 307-G**

stainless steels

**Classifications**

Gas-shielded flux-cored wire

DIN 8555

MF 8-GF-150-KP

**Characteristics**

Flux-cored wire for gas-shielded arc welding giving a 18% Cr – 8% Ni – 7% Mn deposit. Good weldability with either CO<sub>2</sub> or mixed gas. Weld metal has excellent crack resistance even in restrained conditions.

Microstructure: Austenite + 2% Ferrite

Machinability: Good with metallic carbides tipped tools

Oxy-acetylene cutting: Cannot be flame cut

Deposit thickness: As required

Shielding gas: Argon 82% + CO<sub>2</sub> 18% (M21) or 100% CO<sub>2</sub>

**Field of use**

Joining of wear plates on shovel buckets, railways and tramway lines, press rams, joining of stainless steels with carbon manganese steels, building up and buttering before hardfacing, welding of 14% Mn steels, armour and hard to weld steels.

**Typical analysis in %**

C	Mn	Si	Cr	Ni	Fe	Cu
0.1	7.1	0.8	17.9	8.5	balance	0.2

**Typical mechanical properties**

Hardness as welded: 155 HB

**Form of delivery and recommended welding parameters**

Wire diameter [mm]	Amperage [A]	Voltage [V]	Stick-out [mm]	Gas flow [L/min]
1.2	100 – 250	18 – 30	20 max.	12 – 15
1.6	180 – 300	23 – 30	20 max.	15 – 18



**Classifications**

gas-shielded metal-cored wire

DIN 8555

MF 4-GF-50-ST

**Characteristics**

Special iron base alloy designed to rebuild parts in the rubber industry.

Microstructure: Martensite

Machinability: Grinding only

Oxy-acetylene cutting: Cannot be flame cut

Deposit thickness: Depends upon application and procedure used

Shielding gas: Argon 98 % + Oxygen 2 %

**Field of use**

Rubber mixers and blenders.

**Typical analysis in %**

C	Mn	Si	Cr	Ni	Mo	W	V	Fe
0.7	1.2	0.9	12.0	0.7	3.8	0.9	2.0	balance

**Typical mechanical properties**

Hardness as welded: 47 HRC

**Form of delivery and recommended welding parameters**

Wire diameter [mm]	Amperage [A]	Voltage [V]	Stick-out [mm]	Gas flow [L/min]
2.0	250 – 350	20 – 31	20 max.	15 – 18

**SK 402-G**

stainless steels

**Classifications**

gas-shielded metal-cored wire

DIN 8555

MF 8-GF-150-KP

**Characteristics**

Austenitic alloy type 18Cr8Ni7Mn recommended for build up and buffer layer prior to hardfacing. It can also be used for joining of dissimilar metals.

Microstructure: Austenite

Machinability: Good with carbide tipped tools

Oxy-acetylene cutting: Not possible

Deposit thickness: As required

Shielding gas: Argon 98 % + Oxygen 2 %

**Field of use**

Joining of wear plates on shovel buckets, railways and tramway lines, press rams, joining stainless steels to carbon manganese steels, building up and buttering before hardfacing, welding of 14 % Mn steels, armour and hard to weld steels.

**Typical analysis in %**

C	Mn	Si	Cr	Ni	Fe
0.1	6.6	0.6	17.1	7.8	balance

**Typical mechanical properties**

Hardness as welded: 170 HB

**Form of delivery and recommended welding parameters**

Wire diameter [mm]	Amperage [A]	Voltage [V]	Stick-out [mm]	Gas flow [L/min]
1.6	150 – 250	20 – 31	20 max.	15 – 18

**Classifications**

gas-shielded metal-cored wire

DIN 8555

MF 5-GF-40-C

**Characteristics**

Alloy depositing a martensitic steel containing 13% Chromium giving a very good resistance to friction wear and corrosion.

Machinability: Good with carbide tipped tools

Oxy-acetylene cutting: Cannot be flame cut

Deposit thickness: Depends upon application and procedure used

Shielding gas: Argon 98 % + Oxygen 2 % or Argon 100 %

**Field of use**

Continuous casting rollers, valve seats, impellers, steam turbine parts, tap-factory.

**Typical analysis in %**

C	Mn	Si	Cr	Fe
0.08	0.7	0.4	13.0	balance

**Typical mechanical properties**

Hardness as welded: 40 HRC

**Form of delivery and recommended welding parameters**

Wire diameter [mm]	Amperage [A]	Voltage [V]	Stick-out [mm]	Gas flow [L/min]
1.2	110 – 180	20 – 31	20 max.	12 – 15
1.6	150 – 250	20 – 31	20 max.	15 – 18
2.4	250 – 350	20 – 31	20 max.	18 – 20

**SK 420 Mo-G**

stainless steels

**Classifications**

gas-shielded metal-cored wire

DIN 8555

MF6-GF-55-C

**Characteristics**

Alloy depositing a martensitic steel containing 12% chromium with molybdenum giving a good resistance to metal-to-metal wear and corrosion

Microstructure: Martensite

Machinability: Fair with carbide tipped tools

Oxy-acetylene cutting: Cannot be flame cut

Deposit thickness: Depends upon application and procedure used

Shielding gas: Argon 98% + Oxygen 2%

**Field of use**

Dredging pump casings, continuous casting rolls...

**Typical analysis in %**

C	Mn	Si	Cr	Mo	Fe
0.24	1.0	0.4	12.0	0.7	balance

**Typical mechanical properties**

Hardness as welded: 54 HRC

**Form of delivery and recommended welding parameters**

Wire diameter [mm]	Amperage [A]	Voltage [V]	Stick-out [mm]	Gas flow [L/min]
1.2	150 – 250	20 – 31	20 max.	12 – 15

**SK 430-G**

stainless steels

**Classifications**

gas-shielded metal-cored wire

DIN 8555

MF 5-GF-200-C

**Characteristics**

Alloy depositing a ferritic steel containing 17% Chromium designed to resist corrosion at high temperatures, particularly in presence of sulphurous gas.

Microstructure: Ferrite and few martensite

Machinability: Verry good

Oxy-acetylene cutting: Cannot be flame cut

Deposit thickness: Depends upon application and procedure used

Shielding gas: Argon 98 % + Oxygen 2 %

**Field of use**

Continuous casting rollers situated at the top of the line, valves, steam and gas turbine parts, valve seats.

**Typical analysis in %**

C	Mn	Si	Cr	Ti	Fe
0.06	0.8	0.6	17.8	0.2	balance

**Typical mechanical properties**

Hardness as welded: 190 HB

**Form of delivery and recommended welding parameters**

Wire diameter [mm]	Amperage [A]	Voltage [V]	Stick-out [mm]	Gas flow [L/min]
1.2	110 – 180	20 – 31	20 max.	12 – 15
1.6	150 – 250	20 – 31	20 max.	15 – 18

**SK 430 Mo-G**

stainless steels

**Classifications**

gas-shielded metal-cored wire

**Characteristics**

Alloy depositing a ferritic steel containing 17% Chromium enhanced with Molybdenum addition designed to resist corrosion at high temperatures, particularly in presence of sulphurous gas.

Microstructure: Ferrite and few martensite

Machinability: Good

Oxy-acetylene cutting: Cannot be flame cut

Deposit thickness: Depends upon application and procedure used

Shielding gas: If required Argon 98% + Oxygen 2%

**Field of use**

Continuous casting rollers, valves, steam and gas turbine parts, valve seats.

**Typical analysis in %**

C	Mn	Si	Cr	Mo	Fe
0.25	1.0	0.6	19.0	0.9	balance

**Typical mechanical properties**

Hardness as welded: 260 HB

**Form of delivery and recommended welding parameters**

Wire diameter [mm]	Amperage [A]	Voltage [V]	Stick-out [mm]	Gas flow [L/min]
1.6	150 – 250	20 – 31	20 max.	15 – 18

**Classifications** gas-shielded metal-cored wire

DIN 8555	EN 12073	DIN 8556	ASME IIC SFA 5.9
MF 8-GF-C	T 20 25 5 Cu L M M 1	MSG X2-CrNiMoCu 20-25	EC 385

**Characteristics**

Stainless steel metal-cored-wire for all positional gas-shielded welding. Excellent edge blends, arc stability, penetration, weld bead aspect and minimum spatter. Improved welding speed and quality regarding solid wires of the same composition.

Microstructure: Austenite + few Ferrite

Shielding gas: Argon 98 % + CO<sub>2</sub> 2 % or Argon 100 %

**Field of use**

For welding and cladding stainless steels of similar composition where corrosion resistance to hot sulphuric and cold hydrochloric acid is required.

**Typical analysis in %**

C	Mn	Si	Cr	Ni	Mo	N	Fe	Cu
0.02	2.8	0.5	20.5	24.2	5.0	0.12	balance	1.1

**Typical mechanical properties**

Hardness as welded: NA

**Form of delivery and recommended welding parameters**

Wire diameter [mm]	Amperage [A]	Voltage [V]	Stick-out [mm]	Gas flow [L/min]
1.2	100 – 200	19 – 28	20 max.	15 – 20

**SK 741-G**

stainless steels

**Classifications**

gas-shielded metal-cored wire

DIN 8555

MF 5-GF-40-C

**Characteristics**

Alloy depositing a ferritic-martensitic steel containing 13% Chromium, 5% Nickel and 1% Molybdenum designed to resist metal-to-metal wear, corrosion and thermal fatigue fire cracking.

Microstructure: Martensite + 10% Ferrite

Machinability: Good with carbide tipped tools

Oxy-acetylene cutting: Cannot be flame cut

Deposit thickness: Depends upon application and procedure used

Shielding gas: Argon 98% + Oxygen 2%

**Field of use**

Surfacing of continuous casting rollers of very small diameters (< 150 mm).

**Typical analysis in %**

C	Mn	Si	Cr	Ni	Mo	Fe
0.06	0.5	0.6	13.0	5.5	0.8	balance

**Typical mechanical properties**

Hardness as welded: 41 HRC

**Form of delivery and recommended welding parameters**

Wire diameter [mm]	Amperage [A]	Voltage [V]	Stick-out [mm]	Gas flow [L/min]
1.2	110 – 180	20 – 31	20 max.	10 – 18
1.6	150 – 250	20 – 31	20 max.	10 – 18
2.4	250 – 350	20 – 31	20 max.	10 – 18



**Classifications**

gas-shielded metal-cored wire

DIN 8555

MF 5-GF-350-C

**Characteristics**

Alloy depositing a ferritic-martensitic steel containing 13 % Chromium, 5 % Nickel and 2 % Molybdenum designed to resist metal-to-metal wear, corrosion and thermal fatigue fire cracking.

Microstructure: Martensite + Ferrite + residual austenite

Machinability: Good with carbide tipped tools

Oxy-acetylene cutting: Cannot be flame cut

Deposit thickness: Depends upon application and procedure used

Shielding gas: Argon 98 % + Oxygen 2 %

**Field of use**

Surfacing of continuous casting rollers of very small diameters (< 150 mm).

**Typical analysis in %**

C	Mn	Si	Cr	Ni	Mo	Fe
0.02	0.3	0.3	14.5	6.3	2.5	balance

**Typical mechanical properties**

Hardness as welded: 34 HRC

**Form of delivery and recommended welding parameters**

Wire diameter [mm]	Amperage [A]	Voltage [V]	Stick-out [mm]	Gas flow [L/min]
1.2	200 – 250	24 – 28	20 max.	15 – 18

**SK ANTINIT DUR 290**

stainless steels

**Classifications** gas-shielded metal-cored wire

DIN 8555

MF 9-GF-250-CT

**Characteristics**

Alloy providing a strengthening effect at high temperature due to the precipitation of intermetallic components. Special hardfacing iron base alloy designed to resist general corrosion, frictional wear, cavitation, high surface pressures and suitable for applications where a low friction coefficient is profitable.

Microstructure: Austenite + Ferrite + some chromium carbides at the grain boundaries

Machinability: Good

Oxy-acetylene cutting: Cannot be flame cut

Deposit thickness: As required

Shielding gas: Argon 98% + Oxygen 2%

**Field of use**

Hardfacing of the sealing faces of valves and fittings, casings, chutes, slideways, mixer parts, mixer blades.

**Typical analysis in %**

C	Mn	Si	Cr	Ni	Fe
0.06	1.9	5.6	17.0	8.3	balance

**Typical mechanical properties**

Hardness as welded: 250 HB

After PWHT (2 h) at 650 °C: 33 HRC

**Form of delivery and recommended welding parameters**

Wire diameter [mm]	Amperage [A]	Voltage [V]	Stick-out [mm]	Gas flow [L/min]
1.6	200 – 300	21 – 30	15 – 20	15 – 18
2.8	300 – 350	21 – 30	15 – 20	20 – 22

# SK ANTINIT DUR 500

stainless steels

## Classifications

gas-shielded metal-cored wire

DIN 8555

MF 9-GF-45-CT

## Characteristics

For Hardfacing of or austenitic steels exposed to general corrosion, frictional wear, cavitation, or to high surface pressure. For use at temperatures up to 550 °C. Offers additionally enhanced resistance to pitting and intergranular corrosion. Preheating to 450 - 500 °C.

Microstructure: Austenite + Ferrite + some chromium carbides at the grain boundaries

Machinability: Difficult

Oxy-acetylene cutting: Cannot be flame cut

Deposit thickness: As required if interpass temperature (min. 400 °C) is correctly applied

Shielding gas: Argon 98 % + Oxygen 2 % or Argon 100 %

## Field of use

Hard-surfacing of the sealing faces of valves and fittings, casings, chutes, slideways, mixer parts, mixer blades and other parts where a low friction coefficient is called for.

## Typical analysis in %

C	Mn	Si	Cr	Ni	Mo	Nb
0.07	4.3	4.5	17.5	8.0	5.4	1.0

## Typical mechanical properties

Hardness as welded: 43 HRC

After PWHT (2 – 6 h) at 550 °C: 53 HRC

## Form of delivery and recommended welding parameters

Wire diameter [mm]	Amperage [A]	Voltage [V]	Stick-out [mm]	Gas flow [L/min]
1.6	200 – 300	20 – 21	20 max.	15 – 18
2.4	250 – 350	20 – 31	20 max.	15 – 18

## Gas-shielded flux-cored wire

### 1. Seamless flux-cored wires for automated welding

Product name	DIN		HB	HRC	C	Mn	Si
UTP AF ROBOTIC 351 B	8555	MSG 1-350-P	325-375		0.065	1.4	0.6
UTP AF ROBOTIC 352	8555	MSG 1-GF-350-P	325-375		0.25	1.75	0.55
UTP AF ROBOTIC 405	8555	MSG 5-GF-40-P		37-42	0.1	1.5	0.6
UTP AF ROBOTIC 405 B	8555	MSG 5-GF-40-P		37-42	0.1	1.5	0.6
UTP AF ROBOTIC 453	8555	MSG 3-GF-45-ST		42-47	0.25	1	0.4
UTP AF ROBOTIC 503	8555	MSG 3-GF-50-ST		47-52	0.25	0.8	0.4
UTP AF ROBOTIC 600	8555	MSG 6-GF-60-GP		57-60	0.45	0.4	3
UTP AF ROBOTIC 603	8555	MSG 3-GF-60-GPZ		57-62	0.5	1.1	1
UTP AF ROBOTIC 606	8555	MSG 6-GF-60-GP		57-62	0.5	1.4	0.6
UTP AF ROBOTIC 606 B	8555	MSG 6-GF-60-GP		57-62	0.5	1.5	0.6
UTP AF ROBOTIC 6011	8555	MSG 10-GF-65-GP		62-67	0.3	1.1	0.4

#### Solution examples

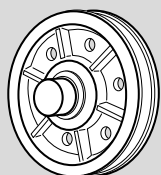

*Carrying wheel / Crane wheel*

UTP AF ROBOTIC 352



*Excavation bucket*

UTP AF ROBOTIC 600

								Type of wear						
Cr	Mo	Ti	Ni	V	W	B	Low stress abrasion	Impact	Corrosion	Cavitation	Metal to metal wear	Heat	Page	
3	1							■			■		308	
1.7								■			■		309	
5.5	0.9							■			■		310	
5.5	0.9							■			■		311	
5	4							■			■	■	312	
5	3.5	0.25						■			■	■	313	
9							■	■			■		314	
5.5	1.3			0.3	1.3		■	■			■	■	315	
6	0.5						■	■			■		316	
6	0.5						■	■			■		317	
0.3			1.5			4.8	■						318	

**UTP AF ROBOTIC 351 B**

Seamless flux-cored wires

**Classifications**

gas-shielded flux-cored wire

DIN 8555

EN 14700

MSG 1-350-P

T Fe 1

**Characteristics**

UTP AF ROBOTIC 351 B is a seamless basic flux-cored wire for hardfacing of components subject to metal wear. For steels that are difficult to weld, a buffer layer using UTP AF 155 flux-cored wire should be applied.

Thanks to its constant wire feed and excellent weldability, this flux-cored wire is especially suited for automated welding.

Application field: pulleys, chains, crawlers and toothed wheels.

**Typical analysis in %**

C	Mn	Si	Cr	Mo
0.065	1.4	0.6	3.0	1.0

**Typical mechanical properties**

Hardness as welded: 325 – 375 HB

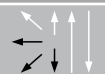
**Welding positions**

Current type: = +

Shielding gas: Ar/CO<sub>2</sub> (EN ISO 14175: M21)

Flow rate: 14 – 20 l/min

**Form of delivery and recommended welding parameters**

Diameter [mm]	Spool	Weight [kg]	Amperage [A]	Voltage [V] [V]
1.6	B300	16	180 – 420	22 – 34

Other diameters on request

## UTP AF ROBOTIC 352

Seamless flux-cored wires

### Classifications

gas-shielded flux-cored wire

DIN 8555

EN 14700

MSG 1 GF-350-P

T Fe 1

### Characteristics

UTP AF ROBOTIC 352 is a seamless, low-alloyed metal-cored wire for surfacing medium-hard steels. For steels that are difficult to weld, a buffer layer using UTP AF 155 should be applied.

Thanks to its constant wire feed and excellent weldability, this flux-cored wire is especially suitable for automated welding.

Application field: Pulleys, chains, crawler rollers and toothed wheels.

### Typical analysis in %

C	Si	Mn	Cr
0.25	0.55	1.75	1.7

### Typical mechanical properties

Hardness as welded: 325-375 HB

### Welding positions

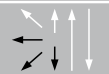

Current type: = +

Shielding gas: Ar/CO<sub>2</sub> (EN ISO 14175: M21)

Flow rate: 14 – 20 l/min

### Form of delivery and recommended welding parameters

Diameter [mm]	Spool	Weight [kg]	Amperage [A]	Voltage [V] [V]
1.2	B 300	16	100 – 220	18 – 26
1.6	B 300	16	100 – 260	18 – 27

Also available on drum spools (250 kgs).

**UTP AF ROBOTIC 405**

Seamless flux-cored wires

**Classifications**

gas-shielded flux-cored wire

DIN 8555

EN 14700

MSG 5-GF-40-P

T Fe 7

**Characteristics**

UTP AF ROBOTIC 405 is a seamless medium-alloyed metal-cored wire with low carbon content for wear-resistant surfacing applications. For steels that are difficult to weld, a buffer layer using UTP AF 155 should be applied.

Thanks to its constant wire feed and excellent weldability, this wire is especially suited for automated welding.

Application field: Parts of earth moving machinery, rollers and supports.  
Machinable with sintered hard metal.

**Typical analysis in %**

C	Mn	Si	Cr	Mo
0.1	1.5	0.6	5.5	0.9

**Typical mechanical properties**

Hardness as welded: 37 – 42 HRC

**Welding positions**

Current type: = +

Shielding gas: Ar/CO<sub>2</sub> (EN ISO 14175: M21)

Flow rate: 14 – 20 l/min

**Form of delivery and recommended welding parameters**

Diameter [mm]	Spool	Weight [kg]	Amperage [A]	Voltage [V] [V]
1.2	B300	16	120 – 300	20 – 32

Other diameters on request



# UTP AF ROBOTIC 405 B

Seamless flux-cored wires

## Classifications

gas-shielded flux-cored wire

DIN 8555

EN 14700

MSG 5-GF-40-P

T Fe 7

## Characteristics

UTP AF ROBOTIC 405 B is a seamless medium-alloyed basic flux-cored wire with low carbon content for wear-resistant surfacing applications. For steels that are difficult to weld, a buffer layer using UTP AF 155 flux-cored wire should be applied.

Thanks to its constant wire feed and excellent weldability, this flux-cored wire is especially suited for automated welding.

Application field: Parts of earth moving machinery, rollers and supports.  
Machinable with sintered hard metal.

## Typical analysis in %

C	Mn	Si	Cr	Mo
0.1	1.5	0.6	5.5	0.9

## Typical mechanical properties

Hardness as welded: 37 – 42 HRC

## Welding positions



Current type: = +

Shielding gas: Ar/CO<sub>2</sub> (EN ISO 14175: M21)  
Flow rate: 14 – 20 l/min

## Form of delivery and recommended welding parameters

Diameter [mm]	Spool	Weight [kg]	Amperage [A]	Voltage [V] [V]
1.6	B300	16	180 – 420	22 – 34
2.4	B300	16	200 – 450	25 – 35

Other diameters on request

**UTP AF ROBOTIC 453**

Seamless flux-cored wires

**Classifications**

gas-shielded flux-cored wire

DIN 8555

EN 14700

MSG 3-GF-45-ST

T Fe 3

**Characteristics**

UTP AF ROBOTIC 453 is a seamless, CrMo alloyed, metal-cored wire for wear-resistant hardfacings on parts subject to abrasion, compression and high temperature. For steels that are difficult to weld, a buffer layer using UTP AF 155 should be applied.

Thanks to its constant wire feed and excellent weldability, this wire is especially suited for automated welding.

Application field: parts of earth moving machinery, rollers, mills and supports.

**Typical analysis in %**

C	Mn	Si	Cr	Mo
0.25	1.0	0.4	5.0	4.0

**Typical mechanical properties**

Hardness as welded: 42 – 47 HRC

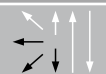
**Welding positions**

Current type: = +

Shielding gas: Ar/CO<sub>2</sub> (EN ISO 14175: M21)  
Flow rate: 16 – 20 l/min

**Form of delivery and recommended welding parameters**

Diameter [mm]	Spool	Weight [kg]	Amperage [A]	Voltage [V] [V]
1.2	B300	16	120 – 300	20 – 32
2.4	B300	16	200 – 450	25 – 35

Other diameters on request

# UTP AF ROBOTIC 503

Seamless flux-cored wires

## Classifications

gas-shielded flux-cored wire

DIN 8555

EN 14700

MSG 3-GF-50-ST

T Fe 8

## Characteristics

UTP AF ROBOTIC 503 is a seamless metal-cored wire for surfacing applications resistant to metal wear and abrasion up to 550 °C. Thanks to its content of titanium carbides, this wire is especially suited for hot-wear-resistant surfacing. For steels that are difficult to weld, a buffer layer using UTP AF 155 should be applied.

Thanks to its constant wire feed and excellent weldability, this wire is especially suited for automated welding.

Application field: Hot work dies, croppers, hot shearing machines, hot rolling, trimmers, extrusions screws, punches and hot cutting tools up to 550 °C.

## Typical analysis in %

C	Mn	Si	Cr	Mo	Ti
0.25	0.8	0.4	5.0	3.5	0.25

## Typical mechanical properties

Hardness as welded: 47 – 52 HRC

## Welding positions

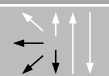

Current type: = +

Shielding gas: Ar/CO<sub>2</sub> (EN ISO 14175: M21)  
Flow rate: 14 – 20 l/min

## Form of delivery and recommended welding parameters

Diameter [mm]	Spool	Weight [kg]	Amperage [A]	Voltage [V] [V]
1.2	B300	16	120 – 300	20 – 32
1.6	B300	16	180 – 420	22 – 34

Other diameters on request.

**UTP AF ROBOTIC 600**

Seamless flux-cored wires

**Classifications**

gas-shielded flux-cored wire

DIN 8555

EN 14700

MSG 3-GF-50-ST

T Fe 8

**Characteristics**

UTP AF ROBOTIC 600 is a seamless, chromium-alloyed, metal-cored wire for wear-resistant hardfacing applications on parts subject to a combination of pressure, impact and abrasion wear. Very good weldability in comparison to solid wires, good resistance to abrasion, minimized slag formation with easy slag removal.

Thanks to its constant wire feed and excellent weldability, this wire is especially suited for automated welding.

Application field: Cutting tools, esp. cutting edges of presses in ceramic tiles production, jaw crushers, baffle plates.

**Typical analysis in %**

C	Mn	Si	Cr
0.45	0.4	3.0	9.0

**Typical mechanical properties**

Hardness as welded: 57 – 62 HRC

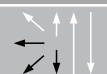
**Welding positions**

Current type: DC (+)

Shielding gas: Ar/CO<sub>2</sub> (EN ISO 14175: M21)  
Flow rate: 14 – 20 l/min

**Form of delivery and recommended welding parameters**

Diameter [mm]	Spool	Weight [kg]	Amperage [A]	Voltage [V] [V]
1.2	B300	16	120 – 300	20 – 32
1.6	B300	16	180 – 420	22 – 34

Other diameters on request.

## UTP AF ROBOTIC 603

Seamless flux-cored wires

### Classifications

gas-shielded flux-cored wire

DIN 8555

EN 14700

MSG 3-GF-60-GPZ

T Fe 8

### Characteristics

UTP AF ROBOTIC 603 is a seamless, chromium-molybdenum-tungsten-vanadium-alloyed, metal-cored wire for abrasion and moderate stress-resistant surfacing applications up to 550 °C.

For steels that are difficult to weld, a buffer layer using UTP AF 155 should be applied.

Thanks to its constant wire feed and excellent weldability, this wire is especially suited for automated welding.

Application field:

Crushing hammers, bulldozer blades, bucket teeth, bucket lips and hammers, cutting tools.

### Typical analysis in %

C	Mn	Si	Cr	Mo	V	W
0.5	1.1	1.0	5.5	1.3	0.3	1.3

### Typical mechanical properties

Hardness as welded: 57 – 62 HRC

### Welding positions

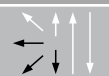

Current type: = +

Shielding gas: ArCO<sub>2</sub> (EN ISO 14175: M21)  
Flow rate: 14 – 20 l/min

### Form of delivery and recommended welding parameters

Diameter [mm]	Spool	Weight [kg]	Amperage [A]	Voltage [V] [V]
1.2	B300	16	120 – 300	20 – 32

Other diameters on request.

**UTP AF ROBOTIC 606**

Seamless flux-cored wires

**Classifications**

gas-shielded flux-cored wire

DIN 8555

EN 14700

MSG 6-GF-60-GP

T Fe 6

**Characteristics**

UTP AF ROBOTIC 606 is a seamless, CrMo-alloyed, metal-cored wire for wear-resistant hardfacing applications up to 700 °C. For steels that are difficult to weld, a buffer layer using UTP AF 155 should be applied.

Thanks to its constant wire feed and excellent weldability, this wire is especially suited for automated welding.

Application field: Parts of earth moving machinery, rollers and mills.

**Typical analysis in %**

C	Mn	Si	Cr	Mo
0.5	1.4	0.6	6.0	0.5

**Typical mechanical properties**

Hardness as welded: 57 – 62 HRC

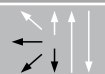
**Welding positions**

Current type: = +

Shielding gas: Ar/CO<sub>2</sub> (EN ISO 14175: M21)  
Flow rate: 14 – 20 l/min

**Form of delivery and recommended welding parameters**

Diameter [mm]	Spool	Weight [kg]	Amperage [A]	Voltage [V] [V]
1.2	B300	16	120 – 300	20 – 32
1.6	B300	16	180 – 420	22 – 34

Other diameters on request

# UTP AF ROBOTIC 606 B

Seamless flux-cored wires

## Classifications

gas-shielded flux-cored wire

DIN 8555

EN 14700

MSG 6-GF-60-GP

T Fe 6

## Characteristics

UTP AF ROBOTIC 606 B is a seamless, basic, CrMo-alloyed wire for wear-resistant surfacing applications up to 700 °C. For steels that are difficult to weld, a buffer layer using UTP AF 155 should be applied.

Thanks to its constant wire feed and excellent weldability, this wire is especially suited for automated welding.

Application field: Parts of earth moving machinery, mills, crushers and supports.

## Typical analysis in %

C	Mn	Si	Cr	Mo
0.5	1.5	0.6	6.0	0.5

## Typical mechanical properties

Hardness as welded: 57 – 62 HRC

## Welding positions

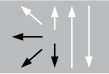

Current type: = +

Shielding gas: Ar/CO<sub>2</sub> (EN ISO 14175: M21)  
Flow rate: 14 – 20 l/min

## Form of delivery and recommended welding parameters

Diameter [mm]	Spool	Weight [kg]	Amperage [A]	Voltage [V] [V]
1.2	B300	16	120 – 300	20 – 32

Other diameters on request

## UTP AF ROBOTIC 6011

Seamless flux-cored wires

## Classifications

gas-shielded flux-cored wire

DIN 8555

EN 14700

MSG 10-GF-65-GP

T Fe 6

## Characteristics

Seamless, NiB-alloyed, metal-cored wire for hardfacing applications. The weld metal characteristics and structure is similar to hard chrome alloys. Excellent resistance to abrasion induced by sand and minerals. The weld metal is machinable only by grinding. Stringer bead technique is recommended. The deposit will readily show stress relief cracks, which do, however, not affect the wear resistance.

Thanks to its constant wire feed and excellent weldability, this wire is especially suited for automated welding.

Application field: This wire is especially suitable for repair of equipment used in mining and steel mills, or hardfacing equipment and tools used in the construction and agriculture industries, highway construction equipment, conveyor chains, mixing paddles, cement pumps components, etc.

## Typical analysis in %

C	Mn	Si	Cr	Ni	B
0.3	1.1	0.4	0.3	1.5	4.8

## Typical mechanical properties

Hardness as welded: 62 – 67 HRC

## Welding positions



Current type: = +

Shielding gas: M21 (EN ISO 14175)  
Flow rate: 15 – 18 l/min

## Form of delivery and recommended welding parameters

Diameter [mm]	Spool	Weight [kg]	Amperage [A]	Voltage [V] [V]
1.2	B300	16	120 – 300	20 – 32
2.0	B300	16	170 – 450	25 – 35

Other diameters on request





## List of contents

### FCAW-O – open arc cored wires

<b>Description of the FCAW-O process</b>	<b>321</b>
<b>Open arc cored wires for repair, anti-wear and anti-corrosion applications</b>	<b>322</b>
1. Manganese steels	322
2. Unalloyed and low alloyed steels	330
3. High alloyed steels	346
4. Stainless steels	376

## Description of the FCAW-O process

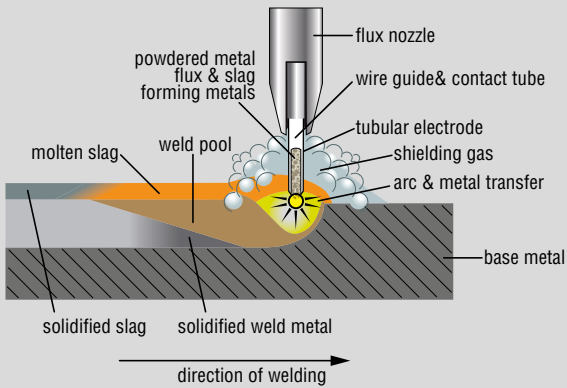

Easy to operate, this welding process guarantees high deposition rates and a good recovery of elements across the arc. Open Arc welding allows the user to get a wide range of alloys and to customize these easily.

## Open arc cored wires for repair, anti-wear and anti-corrosion

### 1. Manganese steels

Product name	DIN		HB	HRC	C	Mn	Si	Cr
SK 14 Mn-O	8555	MF 7-GF-200 / 450-KP	195		0.90	14.0	0.5	0.5
SK 218-O	8555	MF 7-GF-200-KP	200		0.90	14.0	0.5	3.5
SK 313-O	8555	MF 7-GF-200-KP	200		1.12	14.1	0.2	3.3
SK 624-O	8555	MF 7-GF-250-GKP	240		1.00	17.2	0.3	8.2
SK AP-O	8555	MF 7-GF-200-KP	205		0.37	16.0	0.3	12.8
SK AP-OSP	8555	MF 7-GF-200-KP	205		0.39	16.3	0.4	12.9

#### Solution examples

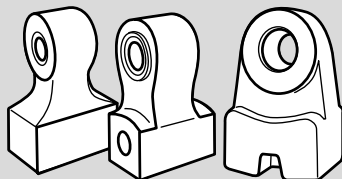
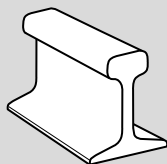

*Rail*

*Crushing hammer*

SK 218-O

SK 624-O

## applications

	Ni	Mo	Nb	Ti	W	Fe	Low stress abrasion	High stress abrasion	Erosion	Impact	Corrosion	Cavitation	Metal to metal wear	Heat	Page
	0.5					Bal.				■					324
	0.4					Bal.				■					325
	3.5					Bal.				■					326
			2.5	0.12		Bal.	■			■					327
						Bal.				■	■				328
						Bal.				■	■				329

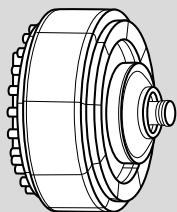

Grinding roller

SK AP-0

**Classifications**

open arc flux-cored wire

DIN 8555

MF 7-GF-200 / 450-KP

**Characteristics**

Self-shielded flux-cored wire depositing an austenitic alloy designed for rebuilding 14 % Manganese steel parts.

Microstructure: Austenite

Machinability: Good with carbide tipped tools

Oxy-acetylene cutting: Cannot be flame cut

Deposit thickness: As required

**Field of use**

Railway rails and crossovers.

**Typical analysis in %**

C	Mn	Si	Cr	Ni	Fe
0.9	14.0	0.5	0.5	0.5	balance

**Typical mechanical properties**

Hardness as welded: 195 HB

**Form of delivery and recommended welding parameters**

Wire diameter [mm]	Amperage [A]	Voltage [V]	Stick-out [mm]
1.6	180 – 200	26 – 30	35 – 40
2.8	300 – 350	26 – 30	35 – 40

**Classifications**

open arc flux-cored wire

DIN 8555

ASME IIC SFA 5.21

MF 7-GF-200-KP

ERC FeMn-G

**Characteristics**

Self-shielded flux-cored wire depositing an austenitic alloy designed for rebuilding of 14 % Manganese steel parts.

Microstructure: Austenite

Machinability: Good with metallic carbide tipped tools

Oxy-acetylene cutting: Cannot be flame cut

Deposit thickness: As required

**Field of use**

Crusher cylinders, crusher hammers, impactor bars.

**Typical analysis in %**

C	Mn	Si	Cr	Ni	Fe
0.9	14.0	0.5	3.5	0.4	balance

**Typical mechanical properties**

Hardness as welded: 200 HB

**Form of delivery and recommended welding parameters**

Wire diameter [mm]	Amperage [A]	Voltage [V]	Stick-out [mm]
1.2	120 – 180	26 – 30	35 – 40
1.6	180 – 200	26 – 30	35 – 40
2.4	250 – 300	26 – 30	35 – 40
2.8	300 – 350	26 – 30	35 – 40

**Classifications**

open arc flux-cored wire

DIN 8555

MF 7-GF-200-KP

**Characteristics**

Self-shielded flux-cored wire depositing an austenitic alloy designed for rebuilding of 14 % Manganese steel parts.

Microstructure: Austenite

Machinability: Good with metallic carbide tipped tools

Oxy-acetylene cutting: Cannot be flame cut.

Deposit thickness: As required

**Field of use**

Crusher cylinders, crusher hammers, impactor bars.

**Typical analysis in %**

C	Mn	Si	Cr	Ni	Fe
1.12	14.1	0.2	3.3	3.5	balance

**Typical mechanical properties**

Hardness as welded: 200 HB

**Form of delivery and recommended welding parameters**

Wire diameter [mm]	Amperage [A]	Voltage [V]	Stick-out [mm]
2.4	250 – 300	26 – 30	35 – 40



**Classifications**

open arc flux-cored wire

DIN 8555

MF 7-GF-250-GKP

**Characteristics**

High Chromium-Manganese alloy enriched with Niobium, designed to resist abrasion and solid erosion wear combined with heavy impact. High Manganese alloy resulting in a workhardenable deposit.

Microstructure: Dispersed Niobium and Chromium carbides in an austenitic matrix

Machinability: Good with metallic carbides or cubic Boron Nitride tipped tools

Oxy-acetylene cutting: Cannot be flame cut

Deposit thickness: Depends upon application and procedure used

**Field of use**

Crusher hammers, gyratory crusher mantles, crusher cylinders, automobile shredder hammers.

**Typical analysis in %**

C	Mn	Si	Cr	Nb	Ti	Fe
1.0	17.2	0.3	8.2	2.5	0.12	balance

**Typical mechanical properties**

Hardness as welded: 240 HB

**Form of delivery and recommended welding parameters**

Wire diameter [mm]	Amperage [A]	Voltage [V]	Stick-out [mm]
1.6	180 – 200	26 – 30	35 – 40
2.4	250 – 300	26 – 30	35 – 40
2.8	300 – 350	26 – 30	35 – 40

**Classifications**

open arc flux-cored wire

DIN 8555

ASME IIC SFA 5.21

MF 7-GF-200-KP

FeMn-Cr

**Characteristics**

Multi-purpose cored wire, mainly used for rebuilding and joining of Carbon and 14 % Manganese steels. Can also be used as buffer layer prior to hard overlay. Work-hardenable alloy.

Microstructure: Austenite

Machinability: Good with metallic carbides tipped tools

Oxy-acetylene cuttin: Cannot be flame cut

Deposit thickness: As required

**Field of use**

Railway rails and crossovers, mill shaft drive ends, gyratory crusher mantles, repointing of shovel teeth, buffer layer for inter-particles crushers.

**Typical analysis in %**

C	Mn	Si	Cr	Fe
0.37	16.0	0.3	12.8	balance

**Typical mechanical properties**

Hardness as welded: 205 HB

**Form of delivery and recommended welding parameters**

Wire diameter [mm]	Amperage [A]	Voltage [V]	Stick-out [mm]
1.2	120 – 150	26 – 30	35 – 40
1.6	180 – 200	26 – 30	35 – 40
2.0	200 – 250	26 – 30	35 – 40
2.4	250 – 300	26 – 30	35 – 40
2.8	300 – 350	26 – 30	35 – 40

**Classifications**

open arc flux-cored wire

DIN 8555

ASME IIC SFA 5.21

MF 7-GF-200-KP

FeMn-Cr

**Characteristics**

Multi-purpose cored wire, mainly used for rebuilding and joining of Carbon and 14% Manganese steels. Can also be used as buffer layer prior to hard overlay. Work-hardenable alloy. Enhanced feedability and weldability.

Microstructure: Austenite

Machinability: Good with metallic carbide tipped tools

Oxy-acetylene cutting: Cannot be flame cut.

Deposit thickness: As required

**Field of use**

Railway rails and crossovers, mill shaft drive ends, gyratory crusher mantles, repointing of shovel teeth, buffer layer for inter-particles crushers.

**Typical analysis in %**

C	Mn	Si	Cr	Fe
0.39	16.3	0.4	12.9	balance

**Typical mechanical properties**

Hardness as welded: 205 HB

**Form of delivery and recommended welding parameters**

Wire diameter [mm]	Amperage [A]	Voltage [V]	Stick-out [mm]
1.6	180 – 200	26 – 30	35 – 40

## Open arc cored wires for repair, anti-wear and anti-corrosion

### 2. Unalloyed and low alloyed steels

Product name	DIN		HB	HRC	C	Mn	Si	Cr
SK 232-0	8555	MF 1-GF-150-P	170		0.04	0.7	0.4	
SK 242-0	8555	MF 1-GF-40-P		40	0.11	0.6	0.6	2.4
SK 252-0	8555	MF 1-GF-45-G		44	0.17	1.4	0.7	2.8
SK 258-0	8555	MF 6-GF-55-GT		55	0.47	1.5	0.8	5.7
SK 258L-0	8555	MF 6-GF-45-GT		46	0.25	1.4	0.7	5.3
SK 258 TIC-0	8555	MF 6-GF-60-GP		58	1.8	0.9	0.2	6.1
SK 300-0	8555	MF 1-GF-300-P	285		0.1	1.1	0.7	0.5
SK 400-0	8555	MF 1-GF-40-P		40	0.13	0.7	0.6	2.4
SK 795-0	8555	MF 6-GF-40-G		40	1.9	1.5	1.8	9
SK A12-0	8555	MF 6-GF-55-G		55	0.35	0.8	3	9.6
SK BU-C1	8555	MF 1-GF-250-P	250		0.04	0.8	0.1	
SK BU-0	8555	MF 1-GF-300-P	280		0.1	0.9	0.6	0.5
SK CrMo21Ni-0	8555	MF 1-GF-350-GP		40	0.08	0.9	0.7	2.3
SK SOUDOCORE-S8-0			190		0.28	0.4	0.1	

#### Solution examples

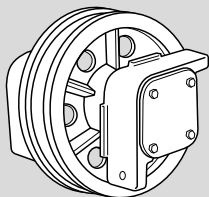

Crane wheel

SK 252-0

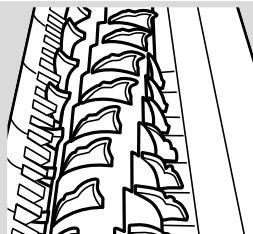

Crusher bucket

SK 258 TIC-0

## applications

Ni	Mo	Nb	Ti	W	Fe	Low stress abrasion	High stress abrasion	Erosion	Impact	Corrosion	Cavitation	Metal to metal wear	Heat	Page
			2.8		Bal.									332
			0.9		Bal.				■			■		333
					Bal.	■			■					334
	1.4			1.5	Bal.	■			■					335
	1.3			1.2	Bal.	■			■			■	■	336
	1.4		5.5		Bal.		■		■					337
	0.3				Bal.				■					338
					Bal.				■			■		339
	1.4				Bal.	■						■		340
			0.5		Bal.	■			■					341
					Bal.				■					342
	0.3				Bal.				■					343
2	1				Bal.				■					344
Others: Al = 1.50					Bal.				■					345

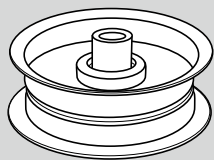

Tractor idler

SK 400-0

**Classifications**

open arc flux-cored wire

DIN 8555

MF 1-GF-150-P

**Characteristics**

Rebuilding alloy for Carbon steel parts.

Microstructure: Bainite

Machinability: Good

Oxy-acetylene cutting: Possible

Deposit thickness: No restriction

**Field of use**

Gears, axles, wheels...

**Typical analysis in %**

C	Mn	Si	Ti	Fe
0.04	0.7	0.4	2.8	balance

**Typical mechanical properties**

Hardness as welded: 170 HB

**Form of delivery and recommended welding parameters**

Wire diameter [mm]	Amperage [A]	Voltage [V]	Stick-out [mm]
2.8	300 – 350	26 – 30	35 – 40

**Classifications**

open arc flux-cored wire

DIN 8555

MF 1-GF-40-P

**Characteristics**

Open-arc wire designed for rebuilding and hard surfacing of Carbon steel parts subjected to adhesive wear with impacts.

Microstructure: Bainite + Martensite

Machinability: Good

Oxy-acetylene cutting: Cannot be flame cut

Deposit thickness: Depends upon application and procedure used

**Field of use**

Crawler tractor rollers and idlers, shafts, cylinders, mine car wheels, crane wheels.

**Typical analysis in %**

C	Mn	Si	Cr	Ti	Fe
0.11	0.6	0.6	2.4	0.9	balance

**Typical mechanical properties**

Hardness as welded: 40 HRC

**Form of delivery and recommended welding parameters**

Wire diameter [mm]	Amperage [A]	Voltage [V]	Stick-out [mm]
1.2	120 – 150	26 – 30	35 – 40
1.6	180 – 200	26 – 30	35 – 40
2.4	250 – 300	26 – 30	35 – 40
2.8	300 – 350	26 – 30	35 – 40

**Classifications**

open arc flux-cored wire

DIN 8555

MF 1-GF-45-G

**Characteristics**

Open-arc wire designed to deposit an alloy resistant to adhesive wear with impacts.

Microstructure: Martensite

Machinability: Good with metallic carbides or Boron Nitride tipped tools

Oxy-acetylene cutting: Cannot be flame cut

Deposit thickness: Depends upon application and procedure used

**Field of use**

Crawler tractor rollers and idlers, crane wheels, shovel bucket rollers, shafts.

**Typical analysis in %**

C	Mn	Si	Cr	Fe
0.17	1.4	0.7	2.8	balance

**Typical mechanical properties**

Hardness as welded: 44 HRC

**Form of delivery and recommended welding parameters**

Wire diameter [mm]	Amperage [A]	Voltage [V]	Stick-out [mm]
1.6	180 – 200	26 – 30	35 – 40
2.0	200 – 250	26 – 30	35 – 40
2.4	250 – 300	26 – 30	35 – 40



**Classifications**

open arc flux-cored wire

DIN 8555

MF 6-GF-55-GT

**Characteristics**

Martensitic alloy designed to give an outstanding resistance to low stress abrasion with heavy impact and high compressive stresses. The deposit is heat treatable and forgeable.

Microstructure: Martensite

Machinability: Grinding only

Oxy-acetylene cutting: Flame cut is difficult

Deposit thickness: Depends upon application and procedure used

**Field of use**

Cable sheaves, bed knives, steel mill rollers, crane wheels, forging dies.

**Typical analysis in %**

C	Mn	Si	Cr	Mo	W	Fe
0.47	1.5	0.8	5.7	1.4	1.5	balance

**Typical mechanical properties**

Hardness as welded: 55 HRC

**Form of delivery and recommended welding parameters**

Wire diameter [mm]	Amperage [A]	Voltage [V]	Stick-out [mm]
1.2	125 – 180	26 – 30	35 – 40
1.6	200 – 300	26 – 30	35 – 40
2.0	200 – 300	26 – 30	35 – 40
2.4	250 – 300	26 – 30	35 – 40
2.8	300 – 350	26 – 30	35 – 40

**SK 258L-0**

Unalloyed and low alloyed steels

**Classifications**

open arc flux-cored wire

DIN 8555

MF 6-GF-45-GT

**Characteristics**

Martensitic alloy giving a very good resistance to metal-to-metal and low stress abrasive wear at high temperature. The deposit is crack-free, heat treatable and forgeable.

Microstructure: Martensite

Machinability: Good with Tungsten carbides or cubic Boron Nitride tipped tools

Oxy-acetylene cutting: Flame cut is difficult

Deposit thickness: Depends upon application and procedure used

**Field of use**

Steel mill rollers, blast furnace bells (seat area), dredger-buckets cylinders.

**Typical analysis in %**

C	Mn	Si	Cr	Mo	W	Fe
0.25	1.4	0.7	5.3	1.3	1.2	balance

**Typical mechanical properties**

Hardness as welded: 46 HRC

**Form of delivery and recommended welding parameters**

Wire diameter [mm]	Amperage [A]	Voltage [V]	Stick-out [mm]
2.4	250 – 300	26 – 30	35 – 40
2.8	300 – 350	26 – 30	35 – 40

**Classifications**

open arc flux-cored wire

DIN 8555

MF 6-GF-60-GP

**Characteristics**

Martensitic Chromium-Titanium alloy designed to resist high stress abrasion with heavy impact. Deposits usually do not relieve cracks.

Microstructure: Finely dispersed Titanium carbides in a hard Chromium martensitic matrix

Machinability: Grinding only

Oxy-acetylene cutting: Cannot be flame cut

Deposit thickness: 15 to 18 mm in 5 to 6 layers

**Field of use**

Crusher rollers, crusher hammers, asphalt mixer blades, agricultural tools, shovel bucket teeth and lips, bulldozer blades, cane knives and shredders, bed knives in the wood pulp industry.

**Typical analysis in %**

C	Mn	Si	Cr	Mo	Ti	Fe
1.8	0.9	0.2	6.1	1.4	5.5	balance

**Typical mechanical properties**

Hardness as welded: 58 HRC

**Form of delivery and recommended welding parameters**

Wire diameter [mm]	Amperage [A]	Voltage [V]	Stick-out [mm]
1.2	120 – 150	26 – 30	35 – 40
1.6	180 – 200	26 – 30	35 – 40
2.0	200 – 280	26 – 30	35 – 40
2.4	250 – 300	26 – 30	35 – 40
2.8	300 – 350	26 – 30	35 – 40

**Classifications**

open arc flux-cored wire

DIN 8555

MF 1-GF-300-P

**Characteristics**

Self-shielded flux-cored wire to be used for rebuilding of Carbon steel parts.

Microstructure: Bainite

Machinability: Good

Oxy-acetylene cutting: Possible

Deposit thickness: Depends upon application and procedure used

**Field of use**

Crawler tractor links, crane wheels, shafts, buffer layer for continuous casting rollers, mine car wheels.

**Typical analysis in %**

C	Mn	Si	Cr	Mo	Fe
0.1	1.1	0.7	0.5	0.3	balance

**Typical mechanical properties**

Hardness as welded: 285 HB

**Form of delivery and recommended welding parameters**

Wire diameter [mm]	Amperage [A]	Voltage [V]	Stick-out [mm]
1.6	180 – 200	26 – 30	35 – 40

**Classifications**

open arc flux-cored wire

DIN 8555

MF 1-GF-40-P

**Characteristics**

Open-arc wire designed for rebuilding and hardfacing of Carbon steel parts subjected to adhesive wear with impacts.

Microstructure: Bainite + Martensite

Machinability: Good

Oxy-acetylene cutting: Cannot be flame cut

Deposit thickness: Depends upon application and procedure used

**Field of use**

Crawler tractor rollers and idlers, shafts, cylinders, mine car wheels, crane wheels.

**Typical analysis in %**

C	Mn	Si	Cr	Fe
0.13	0.7	0.6	2.4	balance

**Typical mechanical properties**

Hardness as welded: 40 HRC

**Form of delivery and recommended welding parameters**

Wire diameter [mm]	Amperage [A]	Voltage [V]	Stick-out [mm]
1.6	180 – 200	26 – 30	35 – 40

**Classifications**

open arc metal cored wire

DIN 8555

MF 6-GF-40-G

**Characteristics**

Medium carbide alloy designed primarily for heavy build – up using automatic processes. The deposits will readily stress relief crack.

Microstructure: Interdendritic eutectic carbides of the type, perlite, austenite partially transformed in bainite, few martensite

Machinability: Grinding only

Oxy – acetylene cutting: Cannot be flame cut

Deposit thickness: 15 to 20 mm

**Field of use**

Dredge pump shells, gyratory crusher mantles and bowls.

**Typical analysis in %**

C	Mn	Si	Cr	Mo	Fe
1.9	1.5	1.8	9.0	1.4	balance

**Typical mechanical properties**

Hardness as welded: 40 HRC

**Form of delivery and recommended welding parameters**

Wire diameter [mm]	Amperage [A]	Voltage [V]	Stick – Out
1.6	150 – 250	26 – 30	35 – 40
2.0	200 – 300	26 – 30	35 – 40
2.4	250 – 300	26 – 30	35 – 40

**Classifications**

open arc flux-cored wire

DIN 8555

MF 6-GF-55-G

**Characteristics**

Martensitic steel alloy designed to resist low stress abrasive wear combined with heavy impact.

Microstructure: Martensite

Machinability: Grinding only

Oxy-acetylene cutting: Cannot be flame cut

Deposit thickness: Up to 4 layers

**Field of use**

Bucket teeth and lips, gravel pumps, screw conveyors, sliding metal parts, gear teeth, crusher hammers, rock drills, etc.

**Typical analysis in %**

C	Mn	Si	Cr	Ti	Fe
0.35	0.8	3.0	9.6	0.5	balance

**Typical mechanical properties**

Hardness as welded: 55 HRC

**Form of delivery and recommended welding parameters**

Wire diameter [mm]	Amperage [A]	Voltage [V]	Stick-out [mm]
1.2	150 – 200	26 – 30	35 – 40
1.6	180 – 200	26 – 30	35 – 40
2.8	300 – 350	26 – 30	35 – 40

**Classifications**

open arc flux-cored wire

DIN 8555

MF 1-GF-250-P

**Characteristics**

Open-arc wire for joining and rebuilding of mild and low alloy steels.

Microstructure: Ferrite

Machinability: Good

Oxy-acetylene cutting: Possible

Deposit thickness: As required

**Field of use**

Profiles, reels, roll construction and reparation, crane wheel.

**Typical analysis in %**

C	Mn	Si	Fe
0.04	0.8	0.1	balance

**Typical mechanical properties**

Hardness as welded: 250 HB

**Form of delivery and recommended welding parameters**

Wire diameter [mm]	Amperage [A]	Voltage [V]	Stick-out [mm]
1.2	120 – 150	26 – 30	35 – 40
1.6	180 – 200	26 – 30	35 – 40
2.8	250 – 300	26 – 30	35 – 40



**Classifications**

open arc flux-cored wire

DIN 8555

MF 1-GF-300-P

**Characteristics**

Rebuilding alloy for Carbon steel parts. Can also be used as buffer layer prior to hard overlay.

Microstructure: Bainite

Machinability: Good

Oxy-acetylene cutting: Possible

Deposit thickness: Depends upon application and procedure used

**Field of use**

Crawler tractor links, crane wheels, shafts, buffer layer for continuous casting rollers, mine car wheels.

**Typical analysis in %**

C	Mn	Si	Cr	Mo	Fe
0.1	0.9	0.6	0.5	0.3	balance

**Typical mechanical properties**

Hardness as welded: 280 HB

**Form of delivery and recommended welding parameters**

Wire diameter [mm]	Amperage [A]	Voltage [V]	Stick-out [mm]
1.2	120 – 150	26 – 30	35 – 40
1.6	180 – 200	26 – 30	35 – 40
2.0	200 – 250	26 – 30	35 – 40
2.4	250 – 300	26 – 30	35 – 40
2.8	300 – 350	26 – 30	35 – 40

**Classifications**

open arc flux-cored wire

DIN 8555

MF 1-GF-350-GP

**Characteristics**

Open-arc cored wire designed for rebuilding and hardfacing for Carbon steel parts.

Microstructure: Bainite

Machinability: Good

Oxy-acetylene cutting: Difficult

Deposit thickness: No restriction

**Field of use**

Crawler tractor links, crane wheels, shafts, buffer layer for continuous casting rollers, mine car wheels.

**Typical analysis in %**

C	Mn	Si	Cr	Ni	Mo	Fe
0.08	0.9	0.7	2.3	2.0	1.0	balance

**Typical mechanical properties**

Hardness as welded: 40 HRC

**Form of delivery and recommended welding parameters**

Wire diameter [mm]	Amperage [A]	Voltage [V]	Stick-out [mm]
1.6	180 – 200	26 – 30	35 – 40

**Classifications**

open arc flux-cored wire

EN 758

ASME IIC SFA 5.20-01

T 42 Z W N 4

E 70 T-4

**Characteristics**

Open-arc flux-cored wire designed for joining and rebuilding of mild and low alloy steels. High deposition rate for applications in flat positions. Highly crack resistant and easy slag removal properties.

Microstructure: Ferrite

Machinability: Good

Oxy-acetylene cutting: Possible

Deposit thickness: No restriction

Shielding gas: Not applicable

**Field of use**

Joining and build-up of carbon steels. Maintenance of slag ladles in steelmaking processes.

**Typical analysis in %**

C	Mn	Si	Al	Fe
0.28	0.4	0.1	1.50	balance

**Typical mechanical properties**

Hardness as welded: 190 HB

**Form of delivery and recommended welding parameters**

Wire diameter [mm]	Amperage [A]	Voltage [V]	Stick-out [mm]
2.0	200 – 550	26 – 35	25 – 50

## Open arc cored wires for repair, anti-wear and anti-corrosion

### 3. High alloyed steels

Product name	DIN		HB	HRC	C	Mn	Si	Cr
SK 162-O	8555	MF 10-GF-65-G		63	5.4	0.2	1.3	27
SK 162 WP-O	8555	MF 10-GF-65-G		63	5.4	0.2	1.3	27
SK 240-O	8555	MF 10-GF-55-G		56	3.5	1.3	1.7	16.5
SK 255 Mo-O	8555	MF 10-GF-60-G		60	5	0.2	0.5	28
SK 255-O	8555	MF 10-GF-60-G		60	5	0.6	1	27
SK 256 Mn-O	8555	MF 10-GF-65-G		63	6.2	2.5	1.4	25
SK 256-O	8555	MF 10-GF-65-G		63	5.5	1.1	1.2	25.7
SK 258 NbC-O	8555	MF 6-GF-60-G		57	1.4	0.7	1.2	5.3
SK 260 NbC-O	8555	MF 6-GF-60		60	1.2	0.6	1.4	5.3
SK 299-O	8555	MF 10-GF-65-GZ		64	4.9	0.2	1	11.3
SK 460-O	8555	MF 10-GF-60-G		57	3.7	0.3	1.1	32
SK 820-O	8555	MF 10-GF-60-G		59	4	0.1	0.1	20
SK 866-O	8555	MF 10-GF-60-G		60	4.5	0.7	0.8	27
SK 867-O	8555	MF 10-GF-60-G		62	5	0.2	1.9	29

## applications

Mo	Nb	W	V	B	Fe	Low stress abrasion	High stress abrasion	Erosion	Impact	Corrosion	Cavitation	Metal to metal wear	Heat	Page
					Bal.		■	■						350
					Bal.		■	■						351
					Bal.		■							352
1.3					Bal.		■	■						353
				0.5	Bal.		■	■						354
					Bal.		■	■						355
					Bal.		■	■						356
	8.5	1.5			Bal.		■		■					357
	8.3	1.2		2	Bal.		■		■					358
	6.8		5.7	0.55	Bal.		■	■					■	359
0.5				0.2	Bal.		■							360
				0.45	Bal.		■	■						361
				0.5	Bal.		■	■						362
				0.5	0.5		■	■						363

## Open arc cored wires for repair, anti-wear and anti-corrosion

### 3. High alloyed steels

Product name	DIN		HB	HRC	C	Mn	Si	Cr
SK 867WP-O	8555	MF 10-GF-60-G		62	5	0.2	1.4	29
SK 900-O	8555	MF 21-GF-65-G		63	2.9	0.4	0.4	5.8
SK A39-O	8555	MF 10-GF-60-G		58	4	0.3	0.7	18.5
SK A43-O	8555	MF 10-GF-65-G		64	5.6	0.2	1.3	20.2
SK A43-OB	8555	MF 10-GF-65-G		65	5.2	0.2	1	20.3
SK A43WP-O	8555	MF 10-GF-65-G		64	5.6	0.2	1.3	20.2
SK A44-O	8555	MF 10-GF-60-G		62	5.2	0.9	0.5	19
SK A45-O	8555	MF 10-GF-65-GT		63	5.3	0.2	0.7	21.2
SK A45W-O	8555	MF 10-GF-65-GT		63	5.3	0.2	0.5	21.2
SK A46-O	8555	MF 10-GF-60-GZ		61	4.7	0.2	1	20.7
SK A64-O	8555	MF 10-GF-65-GT		61	4.8	0.6	1.2	20.5
SK ABRA-MAX-O / G	8555	MF 6-GF-70-GT		70	+	+	+	+

#### Solution examples

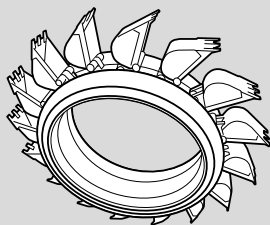

*Bucket wheel*

SK A43-O

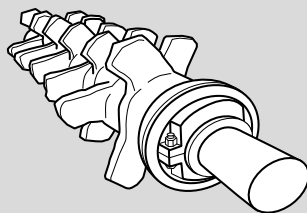

*Sinter spike crusher*

SK A45-O

## applications

Mo	Nb	W	V	B	Fe	Low stress abrasion	High stress abrasion	Erosion	Impact	Corrosion	Cavitation	Metal to metal wear	Heat	Page
				0.5	Bal.		■	■						364
		42			Bal.		■	■						365
	3			0.25	Bal.		■	■						366
	6.7				Bal.		■	■					■	367
	6.7			1	Bal.		■	■					■	368
	6.7				Bal.		■	■					■	369
1.2	5.1	1	1		Bal.		■	■						370
6.3	6.1	1.9	1		Bal.		■	■					■	371
6.2	6.1	1.8	1		Bal.		■	■					■	372
5	Co = 8.8				Bal.		■	■					■	373
			9.9		Bal.		■	■						374
+	+	+	+	+	Bal.		■	■					■	375

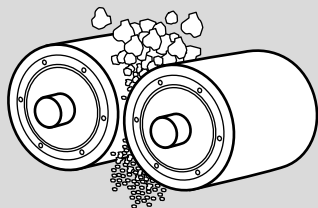

Silicate crusher

SK ABRA-MAX O / G

**Classifications**

open arc metal cored wire

DIN 8555

MF 10-GF-65-G

**Characteristics**

High Chromium alloy designed to resist high stress grinding abrasion with low impact. The deposit will show readily stress relief cracks.

Microstructure: Primary carbides and M7C3 eutectic carbides in an austenitic matrix

Machinability: Grinding only

Oxy-acetylene cutting: Cannot be flame cut

Deposit thickness: 10 to 15 mm maximum in 3 layers

**Field of use**

Gyratory crushers cones and mantles, vertical roller mills, coal pulverizer rolls, wear plates, etc.

**Typical analysis in %**

C	Mn	Si	Cr	Fe
5.4	0.2	1.3	27.0	balance

**Typical mechanical properties**

Hardness as welded: 63 HRC

**Form of delivery and recommended welding parameters**

Wire diameter [mm]	Amperage [A]	Voltage [V]	Stick-out [mm]
2.4	250 – 300	26 – 30	35 – 40
2.8	300 – 500	26 – 30	35 – 40



**Classifications**

open arc metal cored wire

DIN 8555

MF 10-GF-65-G

**Characteristics**

High Chromium alloy designed to resist high stress grinding abrasion with low impact. The deposit will show readily stress relief cracks. Optimized welding behavior for wear plates manufacturing.

Microstructure: Primary carbides and M7C3 eutectic carbides in an austenitic matrix

Machinability: Grinding only

Oxy-acetylene cutting: Cannot be flame cut

Deposit thickness: 10 to 15 mm maximum in 3 layers

**Field of use**

Wear plates.

**Typical analysis in %**

C	Mn	Si	Cr	Fe
5.4	0.2	1.3	27.0	balance

**Typical mechanical properties**

Hardness as welded: 63 HRC

**Form of delivery and recommended welding parameters**

Wire diameter [mm]	Amperage [A]	Voltage [V]	Stick-out [mm]
2.4	250 – 300	26 – 30	35 – 40
2.8	300 – 500	26 – 30	35 – 40

**Classifications**

open arc metal cored wire

DIN 8555

MF 10-GF-55-G

**Characteristics**

Open-arc wire depositing a medium Chromium carbide alloy designed to resist grinding abrasive wear with medium impact.

Microstructure: Interdendritic eutectic carbides in an austenitic matrix

Machinability: Grinding only

Oxy-acetylene cutting: Cannot be flame cut

Deposit thickness: 10 to 12 mm in 2 to 3 layers

**Field of use**

Final overlay on gyratory crusher mantles, augers, crusher hammers and crusher rollers, palm kernels expeller screws.

**Typical analysis in %**

C	Mn	Si	Cr	Fe
3.5	1.3	1.7	16.5	balance

**Typical mechanical properties**

Hardness as welded: 56 HRC

**Form of delivery and recommended welding parameters**

Wire diameter [mm]	Amperage [A]	Voltage [V]	Stick-out [mm]
1.2	120 – 150	26 – 30	35 – 40
1.6	180 – 200	26 – 30	35 – 40

## SK 255 Mo-0

high alloyed steels

### Classifications

open arc metal cored wire

DIN 8555

ASME IIC SFA 5.21

MF 10-GF-60-G

FeCr-A9

### Characteristics

Open-arc metal cored wire designed to deposit a metal resistant to high stress grinding abrasion with low impact. The deposits will readily show stress relief cracks.

Microstructure: Primary carbides and eutectic carbides in an austenitic matrix

Machinability: Grinding only

Oxy-acetylene cutting: Cannot be flame cut

Deposit thickness: 8 to 10 mm maximum in 2 to 3 layers

### Field of use

Concrete pumps, mixer parts, conveyer screws, etc.

### Typical analysis in %

C	Mn	Si	Cr	Mo	Fe
5.0	0.2	0.5	28.0	1.3	balance

### Typical mechanical properties

Hardness as welded: 60 HRC

### Form of delivery and recommended welding parameters

Wire diameter [mm]	Amperage [A]	Voltage [V]	Stick-out [mm]
2.0	200 – 300	26 – 30	35 – 40

**Classifications**

open arc metal cored wire

DIN 8555

ASME IIC SFA 5.21

MF 10-GF-60-G

FeCr-A9

**Characteristics**

Self-shielded cored wire designed to deposit an alloy resistant to high stress grinding abrasion with low impact. The deposits will readily show stress relief cracks.

Microstructure: Primary carbides and eutectic carbides in an austenitic matrix

Machinability: Grinding only

Oxy-acetylene cutting: Cannot be flame cut

Deposit thickness: 8 to 10 mm maximum in 2 to 3 layers

**Field of use**

Palm oil expeller screws, groundnut oil expeller screws, cement conveyors screws, catalytic pipes, dredge pump impellers, dredge cutters, shovel bucket teeth.

**Typical analysis in %**

C	Mn	Si	Cr	B	Fe
5.0	0.6	1.0	27.0	0.5	balance

**Typical mechanical properties**

Hardness as welded: 60 HRC

**Form of delivery and recommended welding parameters**

Wire diameter [mm]	Amperage [A]	Voltage [V]	Stick-out [mm]
1.2	125 – 180	26 – 30	35 – 40
1.6	180 – 200	26 – 30	35 – 40
2.0	200 – 250	26 – 30	35 – 40
2.4	250 – 300	26 – 30	35 – 40

## SK 256 Mn-0

high alloyed steels

### Classifications

open arc metal cored wire

DIN 8555

MF 10-GF-65-G

### Characteristics

Open-arc cored wire depositing an alloy designed to resist high stress grinding abrasion with low impact. The deposits will readily show stress relief cracks.

Microstructure: Primary Chromium carbides (70 %) in an eutectic matrix

Machinability: Grinding only

Oxy-acetylene cutting: Cannot be flame cut

Deposit thickness: 10 to 12 mm maximum in 2 to 3 layers

### Field of use

Wear plates, mining and earthmoving equipment, sand dredge parts, drag line components, etc.

### Typical analysis in %

C	Mn	Si	Cr	Fe
6.2	2.5	1.4	25.0	balance

### Typical mechanical properties

Hardness as welded: 63 HRC

### Form of delivery and recommended welding parameters

Wire diameter [mm]	Amperage [A]	Voltage [V]	Stick-out [mm]
2.8	300 – 550	26 – 34	35 – 40

**Classifications**

open arc metal cored wire

DIN 8555

MF 10-GF-65-G

**Characteristics**

High Chromium carbide alloy designed to resist high stress grinding abrasion with low impact. The deposits will readily show stress relief cracks.

Microstructure: Primary Chromium carbides (70 %) and eutectic carbides in an austenitic matrix

Machinability: Grinding only

Oxy-acetylene cutting: Cannot be flame cut

Deposit thickness: 10 to 12 mm maximum in 2 to 3 layers

**Field of use**

Coal pulverizing rollers, mining and earthmoving equipment, sand dredge parts, drag line components, etc.

**Typical analysis in %**

C	Mn	Si	Cr	Fe
5.5	1.1	1.2	25.7	balance

**Typical mechanical properties**

Hardness as welded: 63 HRC

**Form of delivery and recommended welding parameters**

Wire diameter [mm]	Amperage [A]	Voltage [V]	Stick-out [mm]
1.6	180 – 200	26 – 30	35 – 40
2.4	250 – 300	26 – 30	35 – 40
2.8	300 – 350	26 – 30	35 – 40

**Classifications**

open arc metal cored wire

DIN 8555

MF 6-GF-60-G

**Characteristics**

Open-arc flux-cored wire designed to deposit a crack-free martensitic alloy.

Microstructure: Martensite, little residual austenite and dispersed NbC carbides

Precautions: Preheating temperature 250 °C

Interpass temperature: 300 °C

Stress-relieving: 500 °C for 6 to 8 hours

Machinability: Grinding only

Oxy-acetylene cutting: Cannot be flame cut.

Deposit thickness: Up to 4 layers

**Field of use**

Inter-particles crusher rollers.

**Typical analysis in %**

C	Mn	Si	Cr	Nb	W	Fe
1.4	0.7	1.2	5.3	8.5	1.5	balance

**Typical mechanical properties**

Hardness as welded: 57 HRC

**Form of delivery and recommended welding parameters**

Wire diameter [mm]	Amperage [A]	Voltage [V]	Stick-out [mm]
2.8	300 – 350	26 – 30	35 – 40
3.2	350 – 400	26 – 30	35 – 40

**Classifications**

open arc metal cored wire

DIN 8555

MF 6-GF-60

**Characteristics**

Special crack-free martensitic alloy enhanced with Boron designed to resist high stress abrasive wear.

Microstructure: Martensite and primary niobium carbides

Machinability: Grinding only

Oxy-acetylene cutting: Cannot be flame cut

Deposit thickness: Up to 4 layers

**Field of use**

Hardbanding of drilling pipes.

**Typical analysis in %**

C	Mn	Si	Cr	Nb	W	B	Fe
1.2	0.6	1.4	5.3	8.3	1.2	2.0	balance

**Typical mechanical properties**

Hardness as welded: 60 HRC

**Form of delivery and recommended welding parameters**

Wire diameter [mm]	Amperage [A]	Voltage [V]	Stick-out [mm]
1.6	180 – 200	26 – 30	35 – 40
2.8	300 – 350	26 – 30	35 – 40
3.2	350 – 400	26 – 30	35 – 40



**Classifications**

open arc metal cored wire

DIN 8555

MF 10-GF-65-GZ

**Characteristics**

Hardfacing cored wire for open arc welding designed to surface parts subject to high stress grinding abrasion without impact up to high temperatures (up to 650 °C).

Microstructure: Austenitic matrix with complex carbides

Machinability: Grinding only

Oxy-acetylene cutting: Cannot be flame cut

Deposit thickness: 8 to 10 mm in 2 to 3 layers

**Field of use**

Grizzly bars, chutes, conveyor screws, mixers, mining and earth moving equipment wear parts, clinker crushers, etc.

**Typical analysis in %**

C	Mn	Si	Cr	Nb	V	B	Fe
4.9	0.2	1.0	11.3	6.8	5.7	0.55	balance

**Typical mechanical properties**

Hardness as welded: 64 HRC

**Form of delivery and recommended welding parameters**

Wire diameter [mm]	Amperage [A]	Voltage [V]	Stick-out [mm]
1.6	180 – 200	26 – 30	35 – 40
2.4	250 – 300	26 – 30	35 – 40
2.8	300 – 350	26 – 30	35 – 40

**Classifications**

open arc metal cored wire

DIN 8555

MF 10-GF-60-G

**Characteristics**

High Chromium alloy designed to resist severe abrasive wear with moderate impacts. The deposits will readily show stress relief cracks.

Microstructure: Primary carbides in an eutectic matrix

Machinability: Grinding only

Oxy-acetylene cutting: Cannot be flame cut

Deposit thickness: 10 to 12 mm in 2 to 3 layers

**Field of use**

Auger flights, guides, pump housings.

**Typical analysis in %**

C	Mn	Si	Cr	Mo	B	Fe
3.7	0.3	1.1	32.0	0.5	0.2	balance

**Typical mechanical properties**

Hardness as welded: 57 HRC

**Form of delivery and recommended welding parameters**

Wire diameter [mm]	Amperage [A]	Voltage [V]	Stick-out [mm]
1.6	180 – 200	26 – 30	35 – 40
2.0	200 – 250	26 – 30	35 – 40

**Classifications**

open arc metal cored wire

DIN 8555

MF 10-GF-60-G

**Characteristics**

Hardfacing Chromium carbide alloy recommended for applications combining moderate stress abrasion with moderate impact. The deposit will readily show stress relief cracks.

Microstructure: Primary carbides and eutectic carbides, austenite

Machinability: Grinding only

Oxy-acetylene cutting: Cannot be flame cut

Deposit thickness: 2 to 3 layers maximum

**Field of use**

Wear plates, screw conveyors, shovel bucket teeth and lips, etc.

**Typical analysis in %**

C	Mn	Si	Cr	B	Fe
4.0	0.1	0.1	20.0	0.45	balance

**Typical mechanical properties**

Hardness as welded: 59 HRC

**Form of delivery and recommended welding parameters**

Wire diameter [mm]	Amperage [A]	Voltage [V]	Stick-out [mm]
1.2	120 – 150	26 – 30	35 – 40
1.6	150 – 250	26 – 30	35 – 40

**SK 866-0**

high alloyed steels

**Classifications**

open arc metal cored wire

DIN 8555

MF 10-GF-60-G

**Characteristics**

Alloy designed to resist high stress grinding abrasion with low impact. The deposits will readily show stress relief cracks.

Microstructure: Primary carbides and eutectic carbides in an austenitic matrix

Machinability: Grinding only

Oxy-acetylene cutting: Cannot be flame cut

Deposit thickness: 8 to 10 mm maximum in 2 to 3 layers

**Field of use**

Palm oil expeller screws, groundnut oil expeller screws, cement conveyors screws, catalytic pipes, dredge pump impellers, dredge cutters, shovel bucket teeth, wear plates.

**Typical analysis in %**

C	Mn	Si	Cr	B	Fe
4.5	0.7	0.8	27.0	0.5	balance

**Typical mechanical properties**

Hardness as welded: 60 HRC

**Form of delivery and recommended welding parameters**

Wire diameter [mm]	Amperage [A]	Voltage [V]	Stick-out [mm]
2.4	250 – 300	26 – 30	35 – 40
2.8	300 – 350	26 – 30	35 – 40

**Classifications**

open arc metal cored wire

DIN 8555

MF 10-GF-60-G

**Characteristics**

Alloy designed to resist high stress grinding abrasion with low impact. The deposits will readily show stress relief cracks.

Microstructure: Primary and eutectic carbides in an austenitic matrix

Machinability: Grinding only

Oxy-acetylene cutting: Cannot be flame cut

Deposit thickness: 8 to 10 mm in 2 to 3 layers

**Field of use**

Cement conveyors screws, catalytic pipes, dredge pump impellers, dredge cutters, shovel bucket teeth, wear plates.

**Typical analysis in %**

C	Mn	Si	Cr	B	Fe
5.0	0.2	1.9	29.0	0.5	balance

**Typical mechanical properties**

Hardness as welded: 62 HRC

**Form of delivery and recommended welding parameters**

Wire diameter [mm]	Amperage [A]	Voltage [V]	Stick-out [mm]
2.4	250 – 300	26 – 30	35 – 40
2.8	300 – 500	26 – 30	35 – 40

**Classifications**

open arc metal cored wire

DIN 8555

MF 10-GF-60-G

**Characteristics**

High Chromium alloy designed to resist high stress grinding abrasion with low impact. The deposit will show readily stress relief cracks. Welding properties optimized for wear plates manufacturing.

Microstructure: Primary and eutectic carbides in an austenitic matrix

Machinability: Grinding only

Oxy-acetylene cutting: Cannot be flame cut

Deposit thickness: 8 to 10 mm in 2 to 3 layers

**Field of use**

Wear plates.

**Typical analysis in %**

C	Mn	Si	Cr	B	Fe
5.0	0.2	1.4	29.0	0.5	balance

**Typical mechanical properties**

Hardness as welded: 62 HRC

**Form of delivery and recommended welding parameters**

Wire diameter [mm]	Amperage [A]	Voltage [V]	Stick-out [mm]
2.4	250 – 300	26 – 30	35 – 40
2.8	300 – 500	26 – 30	35 – 40

**Classifications**

open arc metal cored wire

DIN 8555

MF 21-GF-65-G

**Characteristics**

Cored wire containing about 60 % Tungsten carbide particles. The composition and particle size have been optimized to provide the best combination of toughness and wear resistance. The deposit will readily show stress relief cracks.

Microstructure: 65 % Tungsten carbides  
35 % austenite + martensite

Machinability: Grinding only

Deposit thickness: 1 to 2 layers maximum

**Field of use**

Wheel excavator bucket teeth, concrete mixer blades, brick and clay mill augers, crusher rollers, wood chipper spouts and bed knives, dredging wear parts, etc.

**Typical analysis in %**

C	Mn	Si	Cr	W	Fe
2.9	0.4	0.4	5.8	42.0	balance

**Typical mechanical properties**

Hardness as welded: 63 HRC

**Form of delivery and recommended welding parameters**

Wire diameter [mm]	Amperage [A]	Voltage [V]	Stick-out [mm]
1.6	125 – 200	19 – 24	35 – 40
2.0	140 – 250	19 – 24	35 – 40
2.4	150 – 300	19 – 24	35 – 40

**Classifications**

open arc metal cored wire

DIN 8555

MF 10-GF-60-G

**Characteristics**

CrNb alloy with addition of Boron designed to resist high stress grinding and gouging abrasion. The deposit will readily show stress relief cracks.

Microstructure: Eutectic carbides in an austenitic matrix

Machinability: Grinding only

Oxy-acetylene cutting: Cannot be flame cut

Deposit thickness: 8 to 10 mm maximum in 2 to 3 layers

**Field of use**

Bucket teeth and lips on bucket-wheel excavators in coal and phosphate mines, brick and clay mill augers, bucket teeth and lips on shovel buckets and bulldozer blades working in sand, crushing equipment, wear plates, screens in the coal industry, etc.

**Typical analysis in %**

C	Mn	Si	Cr	Nb	B
4.0	0.3	0.7	18.5	3.0	0.25

**Typical mechanical properties**

Hardness: 58 HRC

**Form of delivery and recommended welding parameters**

Wire diameter [mm]	Amperage [A]	Voltage [V]	Stick-out [mm]
2.8	300 – 350	26 – 30	35 – 40



**Classifications**

open arc metal cored wire

DIN 8555

MF 10-GF-65-G

**Characteristics**

CrNb alloy designed to resist high stress grinding abrasion at service temperature not exceeding 450 °C. The deposit will readily show stress relief cracks.

Microstructure: Austenitic matrix with primary & eutectic carbides and nodular Nb carbides

Machinability: Grinding only

Oxy-acetylene cutting: Cannot be flame cut

Deposit thickness: 10 to 12 mm in 2 to 3 layers

**Field of use**

Shovel, excavator, dredge and dragline bucket lips and teeth, hammers, rippers, crushing equipment, wear plates, expeller screws, giratory crushers, etc.

**Typical analysis in %**

C	Mn	Si	Cr	Nb	Fe
5.6	0.2	1.3	20.2	6.7	balance

**Typical mechanical properties**

Hardness as welded: 64 HRC

**Form of delivery and recommended welding parameters**

Wire diameter [mm]	Amperage [A]	Voltage [V]	Stick-out [mm]
1.6	180 – 200	26 – 30	35 – 40
2.0	200 – 250	26 – 30	35 – 40
2.4	250 – 300	26 – 30	35 – 40
2.8	300 – 350	26 – 30	35 – 40

**SK A43-0B**

high alloyed steels

**Classifications**

open arc metal cored wire

DIN 8555

MF 10-GF-65-G

**Characteristics**

CrNb alloy with addition of Boron designed to resist high stress grinding and gouging abrasion. The deposit will readily show stress relief cracks.

Microstructure: Complex carbides in an austenitic matrix

Machinability: Grinding only

Oxy-acetylene cutting: Cannot be flame cut

Deposit thickness: 2 layers maximum

**Field of use**

Shovel, excavator, dredge and dragline bucket lips and teeth, hammers, ripper teeth, crushing equipment, expeller screws, giratory crushers, wear plates, screens in the coal industry, etc.

**Typical analysis in %**

C	Mn	Si	Cr	Nb	B	Fe
5.2	0.2	1.0	20.3	6.7	1.0	balance

**Typical mechanical properties**

Hardness as welded: 65 HRC

**Form of delivery and recommended welding parameters**

Wire diameter [mm]	Amperage [A]	Voltage [V]	Stick-out [mm]
1.6	180 – 200	26 – 30	30 – 35
2.4	250 – 300	26 – 30	30 – 35
2.8	325 – 450	26 – 30	30 – 35

**Classifications**

open arc metal cored wire

DIN 8555

MF 10-GF-65-G

**Characteristics**

CrNb alloy designed to resist high stress grinding abrasion at service temperature not exceeding 450 °C. The deposit will readily show stress relief cracks. Welding properties optimized for wear plates manufacturing.

Microstructure: Austenitic matrix with primary & eutectic carbides and nodular Nb carbides

Machinability: Grinding only

Oxy-acetylene cutting: Cannot be flame cut

Deposit thickness: 10 to 12 mm in 2 to 3 layers

**Field of use**

Wear plates.

**Typical analysis in %**

C	Mn	Si	Cr	Nb	Fe
5.6	0.2	1.3	20.2	6.7	balance

**Typical mechanical properties**

Hardness as welded: 64 HRC

**Form of delivery and recommended welding parameters**

Wire diameter [mm]	Amperage [A]	Voltage [V]	Stick-out [mm]
2.8	300 – 350	26 – 30	35 – 40

**Classifications**

open arc metal cored wire

DIN 8555

MF 10-GF-60-G

**Characteristics**

CrNb alloy with addition of Molybdenum, Tungsten and Vanadium designed to resist high stress and gouging abrasion with moderate impact.

Microstructure: Austenitic matrix with primary & eutectic carbides and nodular Nb carbides

Machinability: Grinding only

Oxy-acetylene cutting: Cannot be flame cut

Deposit thickness: 2 to 3 layers maximum

**Field of use**

Wear plates, blast furnace burden area, chutes.

**Typical analysis in %**

C	Mn	Si	Cr	Mo	Nb	W	V	Fe
5.2	0.9	0.5	19.0	1.2	5.1	1.0	1.0	balance

**Typical mechanical properties**

Hardness as welded: 62 HRC

**Form of delivery and recommended welding parameters**

Wire diameter [mm]	Amperage [A]	Voltage [V]	Stick-out [mm]
1.6	180 – 200	27 – 30	35 – 40

**Classifications**

open arc metal cored wire

DIN 8555

MF 10-GF-65-GT

**Characteristics**

Chromium-Niobium-Molybdenum alloy with addition of Tungsten and Vanadium designed to resist high stress grinding abrasion with low impact and solid erosion at service temperatures up to 650 °C. The deposits will readily show stress relief cracks.

Microstructure: Austenitic matrix with hexagonal primary and eutectic carbides and nodular Nb carbides with complex combined carbides

Oxy-acetylene cutting Cannot be flame cut

Machinability Grinding only

Deposit thickness 8 to 12 mm in 2 or 3 layers

**Field of use**

Wear plates, sinter finger crushers, exhaust fan blades in pellet plants, perlite crushers, bucket teeth and lips on bucketwheel excavators, boiler fan blades, burden area in blast furnace bells, etc.

**Typical analysis in %**

C	Mn	Si	Cr	Mo	Nb	W	V	Fe
5.3	0.2	0.7	21.2	6.3	6.1	1.9	1.0	balance

**Typical mechanical properties**

Hardness as welded: 63 HRC

**Form of delivery and recommended welding parameters**

Wire diameter [mm]	Amperage [A]	Voltage [V]	Stick-out [mm]
1.6	180 – 200	26 – 30	35 – 40
2.0	200 – 250	26 – 30	35 – 40
2.4	250 – 300	26 – 30	35 – 40
2.8	300 – 350	26 – 30	35 – 40

**SK A 45W-O**

high alloyed steels

**Classifications**

open arc metal cored wire

DIN 8555

MF 10-GF-65-GT

**Characteristics**

Chromium-Niobium-Molybdenum alloy with addition of Tungsten and Vanadium designed to resist high stress grinding abrasion with low impact and solid erosion at service temperatures up to 650 °C. The deposits will readily show stress relief cracks.

Microstructure: Austenitic matrix with complex carbides of different types  
Chromium rich hexagonal primary carbides,  
M7C3 eutectic carbides and nodular Niobium carbides.

Machinability: Grinding only

Oxy-acetylene cutting: Cannot be flame cut.

Deposit thickness: 8 to 10 mm in 2 to 3 layers

**Field of use**

Wear plates, Sinter finger crushers, exhaust fan blades in pellet plants, perlite crushers, bucket teeth and lips on bucket-wheel excavators in phosphate mines, Boiler fan blades in the sugar cane industry, burden area in blast furnace bells, wear plates in blast furnace bell-less top charging systems .

**Typical analysis in %**

C	Mn	Si	Cr	Mo	Nb	W	V	Fe
5.5	0.2	0.5	21.2	6.2	6.1	1.8	1.0	balance

**Typical mechanical properties**

Hardness as welded: 63 HRC

**Form of delivery and recommended welding parameters**

Wire diameter [mm]	Amperage [A]	Voltage [V]	Stick-out [mm]
2.8*	300 – 350	26 – 30	35 – 40

\*available on request

**Classifications**

open arc metal cored wire

DIN 8555

MF 10-GF-60-GZ

**Characteristics**

Chromium-Molybdenum-Cobalt alloy designed to resist high stress grinding abrasive wear at service temperature up to 650 °C. The deposit will readily show stress relief cracks. The deposits can be heat treated at 900 °C and then quenched in water to give a hardness of 67 HRC.

Microstructure: Complex carbides in an austenitic matrix

Machinability: Grinding only

Oxy-acetylene cutting: Cannot be flame cut

Deposit thickness: 10 to 12 mm in 2 to 3 layers

**Field of use**

Ore crushers, fan blades, pump casing, sinter plant parts, back-up plates in steel grit blasting equipment.

**Typical analysis in %**

C	Mn	Si	Cr	Mo	Co	Fe
4.7	0.2	1.0	20.7	5.0	8.8	balance

**Typical mechanical properties**

Hardness as welded: 61 HRC

**Form of delivery and recommended welding parameters**

Wire diameter [mm]	Amperage [A]	Voltage [V]	Stick-out [mm]
1.6	180 – 200	26 – 30	35 – 40
2.8	300 – 350	26 – 30	35 – 40

**Classifications**

open arc metal cored wire

DIN 8555

MF 10-GF-65-GT

**Characteristics**

Special Chromium-Vanadium alloy specially developed to resist high stress grinding abrasive wear. The deposit will readily show stress relief cracks.

Microstructure: Austenitic matrix with primary and eutectic carbides enhanced with Vanadium carbides.

Machinability: Grinding only

Oxy-acetylene cutting: Cannot be flame cut

Deposit thickness: Maximum 3 layers

**Field of use**

Mixer blades, armour plates of crushers.

**Typical analysis in %**

C	Mn	Si	Cr	V	Fe
4.8	0.6	1.2	20.5	9.9	balance

**Typical mechanical properties**

Hardness as welded: 61 HRC

**Form of delivery and recommended welding parameters**

Wire diameter [mm]	Amperage [A]	Voltage [V]	Stick-out [mm]
1.6	180 – 200	26 – 30	35 – 40



**Classifications**

open arc metal cored wire

DIN 8555

MF 6-GF-70-GT

**Characteristics**

Special hardfacing cored wire designed to give an extreme resistance against high stress grinding abrasion and erosion without impact. The typical mechanical properties can be achieved in the first layer. The deposit will readily show stress relief cracks.

Microstructure: Complex carbo-borides and borides homogeneously dispersed in the matrix

Oxy-acetylene cutting: Cannot be flame cut

Machinability: Grinding only

Deposit Thickness: ca. 8 mm in maximum 2 layers

Shielding gas: Argon + 2 % Oxygen (if not used as open arc)

**Field of use**

Conveyors screws, crusher plates and rolls, shredder teeth, fan blades, bucket teeth and lips, agricultural machinery, wear plates, etc.

**Typical analysis**

All Weld : C + Cr + Mo + Nb + W + V + B (Bal Fe)

**Typical mechanical properties**

Hardness as welded: 70 HRC

**Form of delivery and recommended welding parameters**

Wire diameter [mm]	Amperage [A]	Voltage [V]	Stick-out [mm]
1.6	180 – 230	26 – 30	20 – 40
2.0	200 – 250	26 – 30	20 – 40
2.4	250 – 300	26 – 30	20 – 40
2.8	300 – 350	26 – 30	35 – 40

## Open arc cored wires for repair, anti-wear and anti-corrosion

### 4. Stainless steels

Product name	DIN		HB	HRC	C	Mn	Si	Cr
SK 308L-0	8555	MF 9-GF-150-C	170		0.02	0.8	0.9	20
SK 309L-0	8555	MF 9-GF-150	170		0.03	0.8	0.9	23
SK 370-0	8555	MF 5-GF-400-C		42	0.03	0.5	0.6	15.5
SK 402-0	8555	MF 8-GF-150 / 400-KPZ	160		0.09	6	0.9	18
SK 415-0	8555	MF 5-GF-50-C		48	0.19	0.8	0.7	13
SK 420-0	8555	MF 6-GF-55-C		54	0.4	0.7	0.2	13.5
SK 430-0	8555	MF 5-GF-250-C	260		0.04	0.9	0.2	17
SK 714 N-0	8555	MF 5-GF-45		44	0.03	1	0.6	13
SK 741-0	8555	MF 5-GF-45-C		43	0.02	0.6	0.6	12.6

#### Solution examples

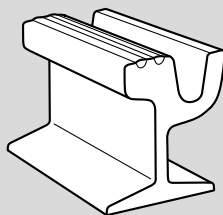

*Rail*

SK 402-0

## applications

Ni	Mo	Nb	Ti	V	Fe	Low stress abrasion	High stress abrasion	Erosion	Impact	Corrosion	Cavitation	Metal to metal wear	Heat	Page
9.5					Bal.					■				378
12					Bal.					■				379
5.2	0.5				Bal.					■		■	■	380
7.8					Bal.			■		■				381
2.2	1		0.25	0.35	Bal.					■		■	■	382
	0.2				Bal.					■		■		383
					Bal.					■				384
4.2	0.5	Other: N = 0.1			Bal.					■		■		385
5.2	0.8				Bal.					■		■	■	386

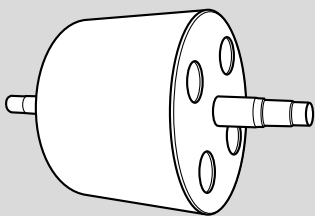

Casting roller

SK 714 N-0

**Classifications**

open arc flux-cored wire

DIN 8555

ASME IIC SFA 5.22

MF 9-GF-150-C

E 308L-T3

**Characteristics**

Self-shielded flux-cored wire depositing a 19 % Chromium, 9 % Nickel, low Carbon stainless steel alloy.

Microstructure: Austenite + / – 10 % ferrite

Machinability: Good

Oxy-acetylene cutting: Cannot be flame cut

Deposit thickness: No restriction

**Field of use**

Cladding stainless steels containing 16 – 21 % Cr and 8 – 13 % Ni on un- or low-alloyed carbon steels.

**Typical analysis in %**

C	Mn	Si	Cr	Ni	Fe
0.02	0.8	0.9	20.0	9.5	balance

**Typical mechanical properties**

Hardness as welded: 170 HB

**Form of delivery and recommended welding parameters**

Wire diameter [mm]	Amperage [A]	Voltage [V]	Stick-out [mm]
1.2	120 – 150	26 – 30	35 – 40
1.6	180 – 220	26 – 30	35 – 40

**Classifications**

open arc flux-cored wire

DIN 8555

MF 9-GF-150

**Characteristics**

Open-arc wire with slag depositing a 23 % Chromium 12 % Nickel low carbon composition suitable for joining dissimilar metals and as buffer layer prior to hard overlays.

Microstructure: Austenite + ferrite

Machinability: Good

Oxy-acetylene cutting: Cannot be flame cut

Deposit thickness: No restriction

**Field of use**

Stainless steel cladding on carbon steels, buffer layers on difficult to weld steels, Corrosion resistant overlays on rail heads submitted to corrosive action.

**Typical analysis in %**

C	Mn	Si	Cr	Ni	Fe
0.03	0.8	0.9	23.0	12.0	balance

**Typical mechanical properties**

Hardness as welded: 170 HB

**Form of delivery and recommended welding parameters**

Wire diameter [mm]	Amperage [A]	Voltage [V]	Stick-out [mm]
1.6	180 – 220	26 – 30	35 – 40

**Classifications**

open arc flux-cored wire

DIN 8555

MF 5-GF-400-C

**Characteristics**

Self-shielded cored wire depositing a ferritic-martensitic steel designed to resist metal-to-metal wear, corrosion and thermal fatigue fire cracking.

Microstructure: Martensite + 10 % Ferrite

Machinability: Good

Oxy-acetylene cutting: Cannot be flame cut

Deposit thickness: Up to 4 layers

**Field of use**

Hardfacing of continuous casting rollers.

**Typical analysis in %**

C	Mn	Si	Cr	Ni	Mo	Fe
0.03	0.5	0.6	15.5	5.2	0.5	balance

**Typical mechanical properties**

Hardness as welded: 42 HRC

**Form of delivery and recommended welding parameters**

Wire diameter [mm]	Amperage [A]	Voltage [V]	Stick-out [mm]	Travel Speed
1.6	180 – 220	26 – 30	30 – 35	30 – 35
2.0	200 – 300	26 – 30	30 – 35	30 – 35
2.4	250 – 360	26 – 30	30 – 35	30 – 35

**Classifications**

open arc flux-cored wire

DIN 8555

MF 8-GF-150 / 400-KPZ

**Characteristics**

Austenitic alloy type 18Cr8Ni7Mn recommended for build up and buffer layer prior to hardfacing. It can also be used for joining of dissimilar metals.

Microstructure: Austenite

Machinability: Good with metallic carbide tipped tools

Oxy-acetylene cutting: Cannot be flame cut

Deposit thickness: As required

**Field of use**

Joining of wear plates on shovel buckets, railways and tramway lines, press rams, joining stainless steels to carbon manganese steels, building up and buttering before hardfacing, welding of 14 % Mn steels, armour and hard to weld steels.

**Typical analysis in %**

C	Mn	Si	Cr	Ni	Fe
0.09	6.0	0.9	18.0	7.8	balance

**Typical mechanical properties**

Hardness as welded: 160 HB

**Form of delivery and recommended welding parameters**

Wire diameter [mm]	Amperage [A]	Voltage [V]	Stick-out [mm]
1.2	120 – 150	26 – 30	35 – 40
1.6	180 – 200	26 – 30	35 – 40
2.0	200 – 250	26 – 30	35 – 40
2.4	250 – 300	26 – 30	35 – 40
2.8	300 – 350	26 – 30	35 – 40

**Classifications**

open arc flux-cored wire

DIN 8555

MF 5-GF-50-C

**Characteristics**

Alloy depositing a ferritic-martensitic steel designed to resist metal-to-metal wear, corrosion and thermal fatigue.

Microstructure: Martensite, little ferrite (10 %)

Machinability: Good with metallic carbide tipped tools

Oxy-acetylene cutting: Cannot be flame cut

Deposit thickness: Depends upon application and procedure used

**Field of use**

Continuous casting rollers.

**Typical analysis in %**

C	Mn	Si	Cr	Ni	Mo	V	Ti	Fe
0.19	0.8	0.7	13.0	2.2	1.0	0.35	0.25	balance

**Typical mechanical properties**

Hardness as welded: 48 HRC

**Form of delivery and recommended welding parameters**

Wire diameter [mm]	Amperage [A]	Voltage [V]	Stick-out [mm]
1.6	180 – 200	26 – 30	35 – 40
2.0	200 – 250	26 – 30	35 – 40



**Classifications**

open arc flux-cored wire

DIN 8555

MF 6-GF-55-C

**Characteristics**

Alloy depositing a martensitic steel containing 13 % Chromium giving a good resistance to metal-to-metal wear and corrosion.

Microstructure: Martensite

Machinability: Good with cubic Boron Nitride tipped tools

Oxy-acetylene cutting: Cannot be flame cut

Deposit thickness: Depends upon application and procedure used

**Field of use**

Dredging pump casings, continuous casting rollers.

**Typical analysis in %**

C	Mn	Si	Cr	Mo	Fe
0.4	0.7	0.2	13.5	0.2	balance

**Typical mechanical properties**

Hardness as welded: 54 HRC

**Form of delivery and recommended welding parameters**

Wire diameter [mm]	Amperage [A]	Voltage [V]	Stick-out [mm]
1.6	180 – 200	26 – 30	35 – 40
2.4	250 – 300	26 – 30	35 – 40
2.8	300 – 350	26 – 30	35 – 40

**Classifications**

open arc flux-cored wire

DIN 8555

MF 5-GF-250-C

**Characteristics**

Alloy depositing a ferritic steel containing 17 % Chromium designed to resist corrosion at high temperatures, particularly in presence of sulphurous gas.

Microstructure: Ferrite and few martensite

Machinability: Very good

Oxy-acetylene cutting: Cannot be flame cut

Deposit thickness: Depends upon application and procedure used

**Field of use**

Continuous casting rollers situated at the top of the line, valves, steam and gas turbine parts, valve seats.

**Typical analysis in %**

C	Mn	Si	Cr	Fe
0.04	0.9	0.2	17.0	balance

**Typical mechanical properties**

Hardness as welded: 260 HB

**Form of delivery and recommended welding parameters**

Wire diameter [mm]	Amperage [A]	Voltage [V]	Stick-out [mm]
1.6	180 – 200	26 – 29	35 – 40
2.0	200 – 300	26 – 29	35 – 40
2.4	250 – 300	26 – 29	35 – 40

**Classifications**

open arc flux-cored wire

DIN 8555

MF 5-GF-45

**Characteristics**

Alloy depositing a ferritic-martensitic steel with addition of nitrogen designed to resist metal-to-metal wear, corrosion and thermal fatigue.

Microstructure: Martensite + ferrite

Machinability: Good with carbide tipped tools

Oxy-acetylene cutting: Cannot be flame cut

Deposit thickness: Depends upon application and procedure used

**Field of use**

Continuous casting rollers.

**Typical analysis in %**

C	Mn	Si	Cr	Ni	Mo	N	Fe
0.03	1.0	0.6	13.0	4.2	0.5	0.1	balance

**Typical mechanical properties**

Hardness as welded: 44 HRC

**Form of delivery and recommended welding parameters**

Wire diameter [mm]	Amperage [A]	Voltage [V]	Stick-out [mm]
2.4	250 – 300	25 – 26	35 – 40

**Classifications**

open arc flux-cored wire

DIN 8555

MF 5-GF-45-C

**Characteristics**

Alloy depositing a ferritic-martensitic steel containing 13 % Chromium, 5 % Nickel and 1 % Molybdenum designed to resist metal-to-metal wear, corrosion and thermal fatigue fire cracking.

Microstructure: Martensite + 10 % Ferrite

Machinability: Good with carbide tipped tools

Oxy-acetylene cutting: Cannot be flame cut

Deposit thickness: Depends upon application and procedure used

**Field of use**

Continuous casting rollers.

**Typical analysis in %**

C	Mn	Si	Cr	Ni	Mo	Fe
0.02	0.6	0.6	12.6	5.2	0.8	balance

**Typical mechanical properties**

Hardness as welded: 43 HRC

**Form of delivery and recommended welding parameters**

Wire diameter [mm]	Amperage [A]	Voltage [V]	Stick-out [mm]
1.6	180 – 200	26 – 29	35 – 40
2.4	250 – 300	26 – 29	35 – 40
2.8	300 – 350	26 – 29	35 – 40



## List of contents

### **SAW – solid wires and fluxes**

**Description of the SAW process** **389**

**SAW wires and fluxes for anti-wear applications** **390**

1. SAW wires 390

2. SAW fluxes 396

**SAW wires and fluxes for anti-corrosion applications** **399**

1. SAW wires 399

2. SAW fluxes 403

## Description of the SAW process

*SAW = Submerged Arc Welding*

**Submerged arc welding is an arc welding process in which the arc burns between an electrode (wire or strip) and the workpiece. The special feature of this method is that the arc burns out of sight in a cavity, filled with gases and vapours, under a layer of coarse-grained, mineral welding flux.**

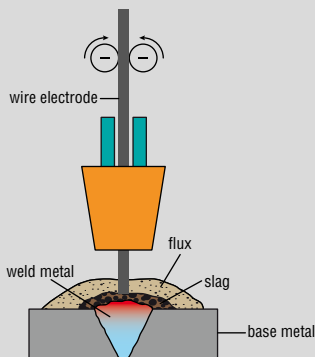

The welding flux melts in the arc, forming a liquid slag that floats on the molten pool, so protecting it from the effects of the atmosphere (like the shielding gas in gas shielded arc welding). The welding electrode, whether wire or strip, is supplied by an automatic feed system, while the welding flux is supplied from a reservoir or through a compressed air feed system. The welding current flows via a contact tube to the electrode immediately above the welding area. This has several advantages, including high current carrying capacity, high deposition rate, and a wide range of possible variations of the welding parameters. The flux coating, moreover, results in high thermal efficiency, and submerged arc welding is therefore known as a high-efficiency process. Turning to detail, there is a distinction in submerged arc welding between single-wire welding, double-wire welding, tandem welding and strip welding.

The composition of the weld metal can be influenced through the right selection of the electrode and flux combination, since chemical reactions between the melt and the slag can control the burn-off and pick-up of alloying elements. The method generates very few emissions, and creates spatter-free seams of high quality.

It is a fully automated welding procedure carried out, for instance, using welding gantries, booms, motorised axis systems or carriages, most often for welding long seams in an industrial context. The method is often employed in shipbuilding, container manufacture, bridge building and steel construction. The method can be applied for joint welding and for build-up welding, for instance for wear or corrosion protection layers.

## SAW wires and fluxes for anti-wear applications

### 1. SAW wires

Product name	EN		Mat.-No.	Page
UTP UP 73 G 2	14700	SZ Fe8	Special Alloy	391
UTP UP 73 G 3	14700	S Fe 3	Special Alloy	392
UTP UP 73 G 4	14700	SZ Fe3	Special Alloy	393
UTP UP DUR 250	14700	SZ Fe1	1.8401	394
UTP UP DUR 350	DIN 8555	UP2-GZ-400	1.8405	395



## Classifications

SAW solid wire

EN 14700	DIN 8555	Material-No.
SZ Fe8	UP 3-GZ-50-T	Special Alloy

## Characteristics and field of use

The SAW wire UTP UP 73 G 2 is used for high wear resistant buildups on construction parts and tools subject to high abrasion and pressure in combination with medium impact loads at elevated performance temperatures, e.g. forging tools, roll mandrills, mangle rolls, thrust rolls as well as for the production of high-grade work surfaces made of non- or low alloyed base materials.

Machinable by grinding or hard metal alloys.

Hardness of the pure weld deposit:  
 untreated: 48 – 52 HRC  
 tempered 550 °C: approx. 55 HRC

## Typical analysis in %

C	Si	Mn	Cr	Mo	Ti	Fe
0.35	0.3	1.2	7.0	2.0	0.3	balance

## Welding instructions

Clean welding area to metallic bright. Preheat massive construction parts and tool steels to 250 – 400 °C, if necessary stress relief annealing at 550 °C. Slow cooling.

## Form of delivery and recommended welding parameters

Wire diameter [mm]	Amperage [A]	Voltage [V]	Travel Speed [cm/min]
3.0*	400 – 500	28 – 30	30 – 50

\*available on request

**Classifications**

SAW solid wire

EN 14700

DIN 8555

Material-No.

S Fe 3

UP 3-GZ-40-T

Special Alloy

**Characteristics and field of use**

Due to the excellent hot wear resistance and toughness, the wire UTP UP 73 G 3 is used for highly stressed surfacings on hot working tools which are simultaneously subject to high mechanical, thermal and abrasive loads, such as forge saddles, rolls, rotors, hot-shear blades.

Machining with hard metal alloys.

Hardness of the pure weld metal:

untreated: 38 – 42 HRC

tempered at 550 °C: approx. 45 HRC

**Typical analysis in %**

C	Si	Mn	Cr	Mo	Ti	Fe
0.25	0.5	0.7	5.0	4.0	0.6	balance

**Welding instructions**

Clean welding area to metallic bright. Preheat massive construction parts and tool steels to 250 – 400 °C, if necessary stress relief annealing at 550 °C. Slow cooling.

**Form of delivery and recommended welding parameters**

Wire diameter [mm]	Amperage [A]	Voltage [V]	Travel Speed [cm/min]
2.4*	300 – 350	28 – 30	30 – 50

\*available on request

## Classifications

SAW solid wire

EN 14700	DIN 8555	Material-No.
SZ Fe3	UP 3-GZ-350-T	Special Alloy

## Characteristics and field of use

Due to the good hot wear resistance and toughness, the wire UTP UP 73 G 4 is used for surfacings on hot working tools and construction parts, which are subject to impact, pressure and abrasion at elevated temperatures, such as rolls, running wheels, guidings, recipients, drums. Hot wear resistant claddings can be made on non- and low alloyed base materials.

The weld deposit is machinable.

Hardness of the pure weld deposit : 32 – 35 HRC

## Typical analysis in %

C	Si	Mn	Cr	Mo	Fe
0.1	0.4	0.6	6.5	3.3	balance

## Welding instructions

Clean welding area to metallic bright, cracks in the tool have to be gouged out completely. Preheating temperature of 400 °C on tools should be maintained, stress relief, if necessary, at 550 °C. Preheating to 150 °C generally on non-and low alloyed materials.

## Form of delivery and recommended welding parameters

Wire diameter [mm]	Amperage [A]	Voltage [V]	Travel Speed [cm/min]
2.4*	300 – 350	28 – 30	30 – 50
3.0*	320 – 450	28 – 30	30 – 50
4.0*	400 – 500	28 – 30	30 – 50

\*available on request

**Classifications**

SAW solid wire

EN 14700

DIN 8555

Material-No.

SZ Fe1

UP 1-GZ-250

1.8401

**Characteristics and field of use**

The SAW wire UTP UP DUR 250 is used for submerged arc welding on construction parts, where resistance against rolling wear and a good machinability is required, such as surfacings on rail crossings, couplings, wobbler drives, crane wheels, shafts and gear parts.

Hardness of the pure weld deposit : approx. 250 HB

**Typical analysis in %**

C	Si	Mn	Cr	Ti	Al	Fe
0.3	0.4	1.0	1.0	0.2	0.1	balance

**Welding instructions**

Clean welding area to metallic bright.  
Preheat massive parts to 150 °C, cooling down slowly.

**Form of delivery and recommended welding parameters**

Wire diameter [mm]	Amperage [A]	Voltage [V]	Travel Speed(cm/min)
3.0*	400 – 500	28 – 30	30 – 50
4.0*	500 – 600	28 – 30	30 – 50

\*available on request

## Classifications

SAW solid wire

DIN 8555

Material-No.

UP2-GZ-400

1.8405

## Characteristics and field of use

UTP UP DUR 350 is used for submerged arc welding on construction parts where resistance against rolling wear and a good machinability is required, such as surfacings on rail crossings, stamps, striking tools, crane wheels, shafts and gear parts.

Hardness of the pure weld deposit : approx. 400 HB

## Typical analysis in %

C	Si	Mn	Cr	Al	Ti	Fe
0.7	0.45	2.0	1.0	0.1	0.2	balance

## Form of delivery and recommended welding parameters

Wire diameter [mm]	Amperage [A]	Voltage [V]	Travel Speed [cm/min]
3.0*	400 – 500	28 – 30	35 – 45
4.0*	500 – 600	28 – 30	35 – 45

\*available on request

## SAW wires and fluxes for anti-wear applications

### 2. SAW fluxes

Product name	EN ISO		AWS		Page
UTP UP FX 603	14174	SA FB 1 54 DC H5			397
UTP UP FX 680	14174	SF CS 2 DC			398

## UTP UP FX 603

anti-wear

### Classifications

SAW flux

EN ISO 14174

SA FB 1 54 DC H5

### Characteristics and field of use

UTP UP FX 603 is an agglomerated fluoride-basic flux for welding of un- and low-alloyed steels.

Its neutral metallurgical behaviour, with respect to Si and Mn, allows a wide application field with un- and low-alloyed wires as well as with flux-cored wires.

Very good slag detachability, even at elevated welding temperatures.

### Chemical composition of the flux (guiding values) in %

SiO <sub>2</sub> + TiO <sub>2</sub>	CaO + MgO	Al <sub>2</sub> O <sub>3</sub> + MnO	CaF <sub>2</sub>
22	35	18	25

### Properties

Basicity grade (according to Boniszewski): 2.6 mol. %, 2.1 wt. %

Grain size, EN ISO 14174: 3 – 20 (0.3 – 2.0 mm)

If the flux has been stored properly (see also: vaBW welding-flux storage guidelines), it can be processed directly out of the package without re-drying. In case of moisture pick-up, the flux should be re-dried prior to use (2 h / 350 – 400 °C).

### Form of delivery

25 kg (plastic bag)

**UTP UP FX 680**

anti-wear

**Classifications**

SAW flux

EN ISO 14174

SF CS 2 DC

**Characteristics and field of use**

UTP UP FX 680 is a neutral, fused sub-arc welding flux of the calcium-silicate-type for joining and hardfacing of low-alloyed heat-resistant steels.

It is a light basic type, has neutral metallurgical behaviour and provides excellent slag detachability. It is designed for use under direct current.

**Chemical composition of the flux (guiding values) in %**

CaF <sub>2</sub>	CaO + MgO	Al <sub>2</sub> O <sub>3</sub>	SiO <sub>2</sub>
20	35	5	30

**Properties**

- Basicity grade (according to Boniszewski) 1.3
- Grain size 0.1 – 1.6 mm (Tyler: 10 x 150)
- Flux consumption ~ 1 (kg flux / kg wire)
- If stored properly / for first use, the flux can be used without redrying directly from the bag. Flux that has become moist should be redried for about 2 hours at 300 – 350 °C prior to use.

**Form of delivery**

15 kg (bags)



## SAW wires and fluxes for anti-corrosion applications

### 1. SAW wires

Product name	EN ISO		AWS		Mat.-No.	Page
UTP UP 068 HH	18274	S Ni 6082 (NiCr20Mn3Nb)	A5.14	ER NiCr-3	2.4806	400
UTP UP 776	18274	S Ni 6276 (NiCr15Mo16Fe6W4)	A5.14	ER NiCrMo-4	2.4886	401
UTP UP 6222 Mo	18274	S Ni 6625 (NiCr22Mo9Nb)	A5.14	ER NiCrMo-3	2.4831	402

**Classifications**

SAW solid wire

EN ISO 18274	AWS A5.14	Material-No.
S Ni 6082 (NiCr20Mn3Nb)	ER NiCr-3	2.4806

**Characteristics and field of use**

UTP UP 068 HH is used for claddings in the reactor construction and for joining of similar base metals and low-alloyed steels with stainless steels:

Mat-No.	DIN	UNS-No.
2.4816	NiCr15Fe	UNS N06600
2.4817	LC-NiCr15Fe	UNS N10665
1.4876	X 10NiCrAlTi 32 20	UNS N08800

**Typical analysis in %**

C	Si	Mn	Cr	Ni	Nb	Fe
< 0.02	< 0.2	3.0	20.0	balance	2.7	0.8

**Mechanical properties of the weld metal according to EN ISO 15792-1 (min. values at RT)**

<i>Yield strength <math>R_{p0.2}</math></i>	<i>Tensile strength <math>R_m</math></i>	<i>Elongation <math>A</math></i>	<i>Impact strength <math>K_v</math></i>
MPa	MPa	%	J (RT)
> 350	> 600	> 35	> 100

**Form of delivery and recommended welding parameters**

<i>Wire diameter [mm]</i>	<i>Amperage [A]</i>	<i>Voltage [V]</i>	<i>Travel Speed [cm/min]</i>
1.6	200 – 250	28 – 30	30 – 50
2.0	250 – 350	28 – 30	30 – 50
2.4	350 – 450	28 – 30	30 – 50

## Classifications

SAW solid wire

EN ISO 18274	AWS A5.14	Material-No.
S Ni 6276 (NiCr15Mo16Fe6W4)	ER NiCrMo-4	2.4886

## Characteristics and field of use

UTP UP 776 is suitable for joining and surfacing on matching and similar alloys such as 2.4819 NiMo16Cr15W UNS N10276 and surface weldings on low-alloyed steels.

UTP UP 776 is employed primarily for welding components in plants for chemical processes with high corrosion resistance in reducing and, above all, in oxidizing environments.

UTP UP 776 is also used for cryogenic applications such as joining 9 % Ni steels.

## Typical analysis in %

C	Si	Mn	P	S	Cr	Mo	Ni	W	Fe
0.02	0.25	1.0	0.008	0.006	16.0	15.5	balance	3.5	6.5

## Mechanical properties of the weld metal according to EN ISO 15792-1 (min. values at RT)

Yield strength $R_{p0.2}$	Tensile strength $R_m$	Elongation $A$	Impact strength $K_V$
MPa	MPa	%	J (RT)
≥ 450	≥ 690	≥ 35	> 70

## Welding instructions

The welding area has to be free of impurities (oil, paint, grease, markings and so on). Welding must be performed with low heat input. The maximum interpass temperature should be kept below 150 °C. Using dried welding flux is mandatory.

## Form of delivery and recommended welding parameters

Wire diameter [mm]	Amperage [A]	Voltage [V]	Travel Speed [cm/min]
1.6	200 – 250	26 – 30	40 – 50
2.4	280 – 350	26 – 30	40 – 50

**UTP UP 6222 Mo**

anti-corrosion

**Classifications**

SAW solid wire

EN ISO 18274	AWS A5.14	Material-No.
S Ni 6625 (NiCr22Mo9Nb)	ER NiCrMo-3	2.4831

**Characteristics and field of use**

UTP UP 6222 Mo is applied for joint welding of base materials with the same or with a similar composition, e.g. Alloy 625 (UNS N06625) or NiCr22Mo9Nb, Material-No. 2.4856 or mixed combinations with stainless steels and carbon steels.

Furthermore the wire is used for cold-tough Ni-steels, e.g. X8Ni9 for LNG projects. UTP UP 6222 Mo is also applied on alloyed or unalloyed steels for cladding of corrosion resistant plants.

**Typical analysis in %**

C	Si	Cr	Mo	Ni	Nb	Fe
< 0.02	< 0.2	21.0	9.0	balance	3.3	1.0

**Mechanical properties of the weld metal according to EN ISO 15792-1 (min. values at RT)**

<i>Yield strength <math>R_{p0.2}</math></i>	<i>Tensile strength <math>R_m</math></i>	<i>Elongation <math>A</math></i>	<i>Impact strength <math>K_V</math></i>	
MPa	MPa	%	J (RT)	- 196 °C
460	725	40	> 80	65

**Welding instructions**

The welding area has to be free from impurities (oil, paint, markings etc.). Welding must be performed with a low heat input. The maximum interpass temperature is at 150 °C. Flux should be redried for approximately 2 hours at 300 – 400 °C prior to use.

**Form of delivery and recommended welding parameters**

<i>Wire diameter [mm]</i>	<i>Amperage [A]</i>	<i>Voltage [V]</i>	<i>Travel Speed [cm/min]</i>
1.6	200 – 250	28 – 30	30 – 50
2.0	250 – 350	28 – 30	30 – 50
2.4	350 – 450	28 – 30	30 – 50
3.2	400 – 450	28 – 30	30 – 50

## SAW wires and fluxes for anti-corrosion applications

### 2. SAW fluxes

Product name	EN ISO		AWS		Page
UTP UP FX 104	14174	SA FB 2 AC			404
UTP UP FX 504	14174	SA AB 2 AC			405

**Classifications**

SAW flux

EN ISO 14174

SA FB 2 AC

**Characteristics and field of use**

UTP UP FX 104 is an agglomerated welding flux of the fluoride-basic type for joining and cladding of stainless and heat resistant steel and nickel based alloys.

It has neutral metallurgical behaviour and no additional Chrome support. It can be used for welding with direct or alternating current set up.

**Chemical composition of the flux (guiding values) in %**

SiO <sub>2</sub> + TiO <sub>2</sub>	CaO + MgO	Al <sub>2</sub> O <sub>3</sub> + MnO	CaF <sub>2</sub>
15	36	20	25

**Properties**

- Basicity grade (according to Boniszewski) 2.7
- Grain size 0.2 – 2.0 mm (Tyler: 10 x 48)

If stored properly the flux can be used without redrying directly from the drum. Flux that has become moist should be redried for approximately 2 hours at 300 – 350 °C prior to use.

**Form of delivery**

30 kg (steel drum)

## Classifications

SAW flux

EN ISO 14174

SA AB 2 AC

## Characteristics and field of use

UTP UP FX 504 is an agglomerated welding flux of the aluminate basic type designed for joining and surfacing applications on unalloyed steels, stainless and heat resistant steels and Ni-base alloys.

It has neutral metallurgical behaviour and provides excellent slag detachability in all applications under direct or alternating current.

## Chemical composition of the flux (guiding values) in %

SiO <sub>2</sub> + TiO <sub>2</sub>	CaO + MgO	Al <sub>2</sub> O <sub>3</sub> + MnO	CaF <sub>2</sub>
8	13	55	22

## Properties

- Basicity grade (according to Boniszewski) Mol. %: 1.5
- Grain size 0.3 – 1.6 mm (Tyler: 10 x 48)

If stored properly the flux can be used without redrying directly from the drum. Flux that has become moist should be redried for around 2 hours at 300 – 350 °C prior to use.

## Form of delivery

30 kg (steel drum)





## List of contents

### SAW – cored wires and fluxes

#### Submerged arc cored wires for anti-wear and anti-corrosion applications **408**

1. Manganese steels 408
2. Unalloyed and low-alloyed steels 412
3. High-alloyed steels 424
4. Tool steels 428
5. Stainless steels 432

#### SAW product selection table **446**

## Submerged arc cored wires for anti-wear and anti-corrosion

### 1. Manganese steels

Product name	DIN		HB	HRC	C	Mn	Si	Cr	
SK 219-S	8555	UP 7-GF-200 / 450-KP	205		0.95	18.0	1.0	4.6	
SK AP-S	8555	UP 7-GF-200-KP	200		0.45	16.0	0.5	13.0	

## applications

Mo	Nb	W	V	Fe	Co	Low stress abrasion	High stress abrasion	Erosion	Impact	Corrosion	Cavitation	Metal to metal wear	Heat	Page
				Bal.					<input checked="" type="checkbox"/>			<input checked="" type="checkbox"/>		410
				Bal.					<input checked="" type="checkbox"/>			<input checked="" type="checkbox"/>		411

**Classifications**

SAW cored wire

DIN 8555

UP 7-GF-200 / 450-KP

**Characteristics**

Designed to deposit by submerged arc welding a fully austenitic alloy in a single layer on Carbon steel parts.

Microstructure: Austenite

Machinability: Good with carbides tipped tools

Oxy-acetylene cutting: Not possible

Deposit thickness: As required

Welding flux: Record SA

**Field of use**

Tramway and railway rails, crossovers, crossing frogs and curves.

**Typical analysis in %**

C	Mn	Si	Cr	Fe
0.95	18.0	1.0	4.6	balance

**Typical mechanical properties**

Hardness as welded: 205 HB

**Form of delivery and recommended welding parameters**

Wire diameter [mm]	Amperage [A]	Voltage [V]	Stick-out [mm]	Flux-Rate [kg per kg wire]	Travel Speed [cm/min]
2.8	300 – 400	28 – 30	30 – 35	1.1	35 – 40
3.2	325 – 450	28 – 30	30 – 35	1.1	35 – 45

**Classifications**

SAW cored wire

DIN 8555

ASME IIC SFA 5.21

UP 7-GF-200-KP

FeMn-Cr

**Characteristics**

Multi-purpose cored wire, mainly used for rebuilding and joining of Carbon and 14 % Manganese steels. Can also be used as buffer layer prior to hard overlay. Work-hardenable alloy.

Microstructure: Austenite

Machinability: Good with metallic carbides tipped tools

Oxy-acetylene cutting: Cannot be flame cut

Deposit thickness: As required

Welding flux: Record SA, Record SR

**Field of use**

Railway rails and crossovers, mill shaft drive ends, gyratory crusher mantles, re-pointing of shovel teeth, buffer layer for inter-particles crushers.

**Typical analysis in %**

C	Mn	Si	Cr	Fe
0.45	16.0	0.5	13.0	balance

**Typical mechanical properties**

Hardness as welded: 200 HB

**Form of delivery and recommended welding parameters**

Wire diameter [mm]	Amperage [A]	Voltage [V]	Stick-out [mm]	Flux-Rate [kg per kg wire]	Travel Speed [cm/min]
2.4	275 – 450	28 – 30	30 – 35	1.1	35 – 45
3.2	325 – 500	28 – 32	30 – 35	1.1	40 – 50

## Submerged arc cored wires for anti-wear and anti-corrosion

### 2. Unalloyed and low-alloyed steels

Product name	DIN		HB	HRC	C	Mn	Si	Cr
SK 20 CrMo-SA	8555	UP 1-GF-200	250		0.13	1.0	0.4	0.6
SK 242-S	8555	UP 1-GF-40-P		40	0.14	1.6	0.7	2.0
SK 258-SA	8555	UP 6-GF-55-GT		57	0.5	1.5	0.6	6.2
SK 258L-SA	8555	UP 6-GF-45-GT		44	0.18	1.5	0.4	5.6
SK 258 NbC-SA	8555	UP 6-GF-60-G		57	1.2	0.8	0.8	6.0
SK 263-SA	8555	UP 6-GF-50-GP		50	0.23	1.2	0.7	6.0
SK 350-S	8555	UP 1-350	320		0.07	1.4	0.3	4.0
SK BU-S	8555	UP 1-GF-300-P	280		0.1	0.9	0.6	0.5
SK CrMo15-SA	8555	UP 1-GF-250	230		0.02	0.8	0.6	1.1
SK SOUDOCORE D-SA	8555	UP 1-GF-200-GP	190		0.09	1.5	0.5	

#### Solution examples

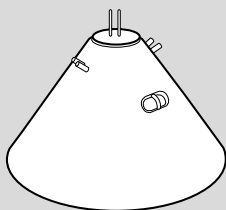

*Blast furnace bell (seat area)*

SK 258L-SA

## applications

Mo	Nb	W	V	Fe	Co	Low stress abrasion	High stress abrasion	Erosion	Impact	Corrosion	Cavitation	Metal to metal wear	Heat	Page
0.3				Bal.					■					414
0.7			0.4	Bal.					■			■		415
1.7		1.7		Bal.			■		■			■		416
1.7		1.5		Bal.					■			■		417
	8.0	1.4		Bal.		■			■			■		418
2.7				Bal.		■			■			■		419
0.5	0.1			Bal.					■					420
0.3				Bal.					■					421
0.4				Bal.					■					422
				Bal.					■					423

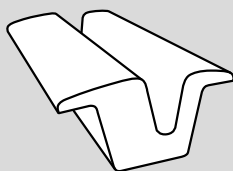

Tramway rail

SK BU-S

## Classifications

SAW cored wire

DIN 8555	ASME IIC SFA 5.23	ASME IIC SFA 5.23
UP 1-GF-200	F9P2-ECB1-B1	F10A0-ECB1-B1

## Characteristics

Cored wire designed to deposit a 0.2%C-0.5%Cr-0.2%Mo alloy for submerged arc welding of unalloyed and low-alloyed steels.

Microstructure: Ferritic

Machinability: Good

Oxy-acetylene cutting: Possible

Deposit thickness: Depends upon application and procedure used

Welding flux: Record SA

## Field of use

Heat resistant steel, steel casting, buffer layers.

## Typical analysis in %

C	Mn	Si	Cr	Mo	Fe
0.13	1.0	0.4	0.6	0.3	balance

## Typical mechanical properties

Hardness as welded: 250 HB

## Form of delivery and recommended welding parameters

Wire diameter [mm]	Amperage [A]	Voltage [V]	Stick-out [mm]	Flux-Rate [kg per kg wire]	Travel Speed [cm/min]
2.4	275 – 450	28 – 30	30 – 35	1.1	35 – 45
3.2	325 – 450	30 – 32	30 – 35	1.1	35 – 45



**Classifications**

SAW cored wire

DIN 8555

UP 1-GF-40-P

**Characteristics**

Submerged arc surfacing wire for rebuilding and hard surfacing alloy of Carbon steel parts subjected to adhesive wear with impacts.

Microstructure: Bainite + Martensite

Machinability: Good

Oxy-acetylene cutting: Cannot be flame cut

Deposit thickness: Depends upon application and procedure used

Welding flux: Record SA

**Field of use**

Crawler tractor rollers and idlers, shafts, cylinders, mine car wheels, crane wheels.

**Typical analysis in %**

C	Mn	Si	Cr	Mo	V	Fe
0.14	1.6	0.7	2.0	0.7	0.4	balance

**Typical mechanical properties**

Hardness as welded: 40 HRC

**Form of delivery and recommended welding parameters**

Wire diameter [mm]	Amperage [A]	Voltage [V]	Stick-out [mm]	Flux-Rate [kg per kg wire]	Travel Speed [cm/min]
3.2	325 – 450	28 – 30	30 – 35	1.1	35 – 45

**SK 258-SA**

Unalloyed and low-alloyed steels

**Classifications**

SAW cored wire

DIN 8555

UP 6-GF-55-GT

**Characteristics**

Martensitic alloy designed to give an outstanding resistance to low stress abrasion with heavy impact and high compressive stresses. The deposit is heat treatable and forgeable.

Microstructure: Martensite

Machinability: Grinding only

Oxy-acetylene cutting: Flame cut is difficult

Deposit thickness: Depends upon application and procedure used

Welding flux: Record SA, Record SR

**Field of use**

Cable sheaves, bed knives, steel mill rollers, crane wheels, forging dies.

**Typical analysis in %**

C	Mn	Si	Cr	Mo	W	Fe
0.5	1.5	0.6	6.2	1.7	1.7	balance

**Typical mechanical properties**

Hardness as welded: 57 HRC

**Form of delivery and recommended welding parameters**

Wire diameter [mm]	Amperage [A]	Voltage [V]	Stick-out [mm]	Flux-Rate [kg per kg wire]	Travel Speed [cm/min]
2.4	275 – 450	28 – 30	30 – 35	1.1	35 – 45
3.2	325 – 500	28 – 32	30 – 35	1.1	40 – 50
4.0	380 – 550	28 – 32	30 – 35	1.1	40 – 50

**Classifications**

SAW cored wire

DIN 8555

UP 6-GF-45-GT

**Characteristics**

Martensitic alloy giving a very good resistance to metal-to-metal and low stress abrasive wear at high temperature. The deposit is crack-free, heat treatable and forgeable.

Microstructure: Martensite

Machinability: Good with Tungsten carbides or cubic Boron Nitride tipped tools

Oxy-acetylene cutting: Flame cut is difficult

Deposit thickness: Depends upon application and procedure used

Welding flux: Record SA, Record SR

**Field of use**

Steel mill rollers, blast furnace bells (seat area), dredger-buckets cylinders.

**Typical analysis in %**

C	Mn	Si	Cr	Mo	W	Fe
0.18	1.5	0.4	5.6	1.7	1.5	balance

**Typical mechanical properties**

Hardness as welded: 44 HRC

**Form of delivery and recommended welding parameters**

Wire diameter [mm]	Amperage [A]	Voltage [V]	Stick-out [mm]	Flux-Rate [kg per kg wire]	Travel Speed [cm/min]
2.4	275 – 450	28 – 30	30 – 35	1.1	35 – 45
2.8	300 – 400	28 – 30	30 – 35	1.1	35 – 45
3.2	325 – 500	28 – 32	30 – 35	1.1	40 – 50

**Classifications**

SAW cored wire

DIN 8555

UP 6-GF-60-G

**Characteristics**

Sub-arc flux-cored wire designed to deposit a crack-free martensitic alloy.

Microstructure: Martensite, little residual austenite and dispersed NbC carbides

Precautions: Preheating temperature 250 °C / Interpass temperature 300 °C

Stress-relieving: 500 °C for 6 to 8 hours

Machinability: Grinding only

Oxy-acetylene cutting: Cannot be flame cut

Deposit thickness: Up to 4 layers

Welding flux: Record SA

**Field of use**

Inter-particles crusher rollers.

**Typical analysis in %**

C	Mn	Si	Cr	Nb	W	Fe
1.2	0.8	0.8	6.0	8.0	1.4	balance

**Typical mechanical properties**

Hardness as welded: 57 HRC

**Form of delivery and recommended welding parameters**

Wire diameter [mm]	Amperage [A]	Voltage [V]	Stick-out [mm]	Flux-Rate [kg per kg wire]	Travel Speed [cm/min]
3.2	325 – 500	28 – 32	30 – 35	1.1	40 – 50

**Classifications**

SAW cored wire

DIN 8555

UP 6-GF-50-GP

**Characteristics**

Martensitic alloy giving a very good resistance against metal-to-metal and low stress abrasive wear at high temperature. The deposit is crack-free, heat treatable and forgeable.

Microstructure: Martensite

Machinability: Good with Tungsten carbides or cubic Boron Nitride tipped tools

Oxy-acetylene cutting: Flame cut is difficult

Deposit thickness: Depends upon application and procedure used

Welding flux: Record SA, Record SR

**Field of use**

Steel mill rollers, blast furnace bells (seat area), dredger-buckets cylinders.

**Typical analysis in %**

C	Mn	Si	Cr	Mo	Fe
0.23	1.2	0.7	6.0	2.7	balance

**Typical mechanical properties**

Hardness as welded: 50 HRC

**Form of delivery and recommended welding parameters**

Wire diameter [mm]	Amperage [A]	Voltage [V]	Stick-out [mm]	Flux-Rate [kg per kg wire]	Travel Speed [cm/min]
3.2	325 – 500	28 – 32	30 – 35	1.1	40 – 50

**SK 350-S**

Unalloyed and low-alloyed steels

**Classifications**

SAW cored wire

DIN 8555

UP 1-350

**Characteristics**

Rebuilding and hardfacing alloy for Carbon steel parts.

Microstructure: Bainite

Machinability: Good

Oxy-acetylene cutting: Cannot be flame cut

Deposit thickness: As required

**Field of use**

Sliding metal parts, gear teeth, undercarriage links, rollers and idlers, shafts, bushing.

**Typical analysis in %**

C	Mn	Si	Cr	Mo	Nb	Fe
0.07	1.4	0.3	4.0	0.5	0.1	balance

**Typical mechanical properties**

Hardness as welded: 320 HB

**Form of delivery and recommended welding parameters**

Wire diameter [mm]	Amperage [A]	Voltage [V]	Stick-out [mm]	Flux-Rate [kg per kg wire]	Travel Speed [cm/min]
3.2	325 – 450	26 – 30	35 – 40	1.1	40 – 50

**Classifications**

SAW cored wire

DIN 8555

UP 1-GF-300-P

**Characteristics**

Rebuilding alloy for Carbon steel parts. Can also be used as buffer layer prior to hard overlay.

Microstructure: Bainite

Machinability: Good

Oxy-acetylene cutting: Possible

Deposit thickness: Depends upon application and procedure used

Welding flux: Record SA

**Field of use**

Crawler tractor links, crane wheels, shafts, buffer layer for continuous casting rollers, mine car wheels.

**Typical analysis in %**

C	Mn	Si	Cr	Mo	Fe
0.1	0.9	0.6	0.5	0.3	balance

**Typical mechanical properties**

Hardness as welded: 280 HB

**Form of delivery and recommended welding parameters**

Wire diameter [mm]	Amperage [A]	Voltage [V]	Stick-out [mm]	Flux-Rate [kg per kg wire]	Travel Speed [cm/min]
2.4	280 – 350	26 – 30	30 – 35	1.1	35 – 45
3.2	325 – 450	28 – 30	30 – 35	1.1	35 – 45

## Classifications

SAW cored wire

DIN 8555

ASME IIC SFA 5.23

ASME IIC SFA 5.23

UP 1-GF-250

F9P2-ECB2-B2

F10A10-ECB2-B2

## Characteristics

Cored wire for joining and rebuilding of mild and low alloy steels. Can also be used as buffer layer prior to hardfacing.

Microstructure: Ferritic

Machinability: Good with conventional tools

Oxy-acetylene cutting: Cannot be flame cut

Deposit thickness: Depends upon application and procedure used

Welding flux: Record SA

## Field of use

Joining and rebuilding of heat resistant steel and steel casting parts. Buffer layers.

## Typical analysis in %

C	Mn	Si	Cr	Mo	Fe
0.02	0.8	0.6	1.1	0.4	balance

## Typical mechanical properties

Hardness as welded: 230 HB

## Form of delivery and recommended welding parameters

Wire diameter [mm]	Amperage [A]	Voltage [V]	Stick-out [mm]	Flux-Rate [kg per kg wire]	Travel Speed [cm/min]
2.0	250 – 400	28 – 30	30 – 35	1.1	35 – 45
2.4	275 – 450	28 – 30	30 – 35	1.1	35 – 45
3.2	325 – 500	28 – 30	30 – 35	1.1	35 – 45



# SK SOUDOCORE D-SA

Unalloyed and low-alloyed steels

## Classifications

SAW cored wire

DIN 8555

ASME IIC SFA 5.17

UP 1-GF-200-GP

F7A8-EC1

## Characteristics

Flux cored wire for submerged arc welding designed for rebuilding and buffering prior to hardfacing. High deposition rate. Excellent mechanical properties.

Microstructure: Ferrite

Machinability: Excellent

Oxy-acetylene cutting: Can be flame cut

Deposit thickness: No restriction

Welding flux: Record SA

## Field of use

Cushion layer on inter-particles crusher cylinder (Polysius; Fuller).

## Typical analysis in %

C	Mn	Si	Fe
0.09	1.5	0.5	balance

## Typical mechanical properties

Hardness as welded: 190 HB

## Form of delivery and recommended welding parameters

Wire diameter [mm]	Amperage [A]	Voltage [V]	Stick-out [mm]	Flux-Rate [kg per kg wire]	Travel Speed [cm/min]
4.0	380 – 700	28 – 33	30	1.1	40 – 60

## Submerged arc cored wires for anti-wear and anti-corrosion

### 3. High-alloyed steels

Product name	DIN		HB	HRC	C	Mn	Si	Cr
SK 255-S	8555	UP 10-GF-60-G		58	4.6	0.9	0.5	27.0
SK A45-S	8555	UP 10-GF-65-GT		64	5.1	0.2	0.6	21.5

## applications

Mo	Nb	W	V	Fe	Co	Low stress abrasion	High stress abrasion	Erosion	Impact	Corrosion	Cavitation	Metal to metal wear	Heat	Page
				Bal.			■							426
5.4	5.7	1.9	0.95	Bal.			■	■					■	427

**Classifications**

SAW cored wire

DIN 8555

ASME IIC SFA 5.21

UP 10-GF-60-G

FeCr-A9

**Characteristics**

Cored wire for sub-arc welding designed to resist high stress grinding abrasion with low impact. The deposits will readily show stress relief cracks.

Microstructure: Primary carbides and eutectic carbides in an austenitic matrix

Machinability: Grinding only

Oxy-acetylene cutting: Cannot be flame cut

Deposit thickness: 8 to 10 mm maximum in 2 to 3 layers

Welding flux: Record SA

**Field of use**

Palm oil expeller screws, groundnut oil expeller screws, cement conveyors screws, catalytic pipes, dredge pump impellers, dredge cutters, shovel bucket teeth.

**Typical analysis in %**

C	Mn	Si	Cr	Fe
4.6	0.9	0.5	27.0	balance

**Typical mechanical properties**

Hardness as welded: 58 HRC

**Form of delivery and recommended welding parameters**

Wire diameter [mm]	Amperage [A]	Voltage [V]	Stick-out [mm]	Flux-Rate [kg per kg wire]	Travel Speed [cm/min]
3.2	325 – 450	28 – 30	30 – 35	1.1	35 – 45

## SK A45-S

high-alloyed steels

### Classifications

SAW cored wire

DIN 8555

UP 10-GF-65-GT

### Characteristics

Chromium-Niobium-Molybdenum alloy with addition of Tungsten and Vanadium designed to resist high stress grinding abrasion with low impact and solid erosion at service temperatures up to 650 °C. The deposits will readily show stress relief cracks.

Microstructure: Complex carbides and Nb nodular carbides in an austenitic matrix

Machinability: Grinding only

Oxy-acetylene cutting: Cannot be flame cut

Deposit thickness: 8 to 12 mm in 2 or 3 layers

Welding flux: Record SA, Record SR

### Field of use

Wear plates, sinter finger crushers, exhaust fan blades in pellet plants, perlite crushers, bucket teeth and lips on bucketwheel excavators, Boiler fan blades, burden area in blast furnace bells, etc.

### Typical analysis in %

C	Mn	Si	Cr	Mo	Nb	W	V	Fe
5.1	0.2	0.6	21.5	5.4	5.7	1.9	0.95	balance

### Typical mechanical properties

Hardness as welded: 64 HRC

### Form of delivery and recommended welding parameters

Wire diameter [mm]	Amperage [A]	Voltage [V]	Stick-out [mm]	Flux-Rate [kg per kg wire]	Travel Speed [cm/min]
3.2	325 – 380	26 – 32	30 – 35	1.1	35 – 45

## Submerged arc cored wires for anti-wear and anti-corrosion

### 4. Tool steels

Product name	DIN		HB	HRC	C	Mn	Si	Cr
SK D35-S	8555	UP 5-GF-50-CT		47	0.12	0.2	0.5	15.0

# applications

Mo	Nb	W	V	Fe	Co	Low stress abrasion	High stress abrasion	Erosion	Impact	Corrosion	Cavitation	Metal to metal wear	Heat	Page
2.3				Bal.	13.5					<input checked="" type="checkbox"/>	<input checked="" type="checkbox"/>	<input checked="" type="checkbox"/>	<input checked="" type="checkbox"/>	430

**SK D35-S**

tool steels

**Classifications**

SAW cored wire

DIN 8555

UP 5-GF-50-CT

**Characteristics**

Special Iron-Chromium-Cobalt-Molybdenum alloy designed to resist metal-to-metal wear, fatigue, oxidation, cavitation and corrosion at high temperature. The typical hardness can be achieved in the first layer.

Microstructure: Martensite + 15 % ferrite (in first layer)

Machinability: Good with metallic carbide tipped tools

Oxy-acetylene cutting: Cannot be flame cut

Deposit thickness: Depends upon application and procedure used

Welding flux: Record SA, Record SR

**Field of use**

Continuous casting driving rollers, dies, mandrels, blanking punches, forming and punching tools, forging dies, swaging dies, pump elements.

**Typical analysis in %**

C	Mn	Si	Cr	Mo	Co	Fe
0.12	0.2	0.5	15.0	2.3	13.5	balance

**Typical mechanical properties**

Hardness as welded: 47 HRC

**Form of delivery and recommended welding parameters**

Wire diameter [mm]	Amperage [A]	Voltage [V]	Stick-out [mm]	Flux-Rate [kg per kg wire]	Travel Speed [cm/min]
2.4	275 – 450	28 – 30	30 – 35	1.1	35 – 45





431

## Submerged arc cored wires for anti-wear and anti-corrosion

### 5. Stainless steels

Product name	DIN		HB	HRC	C	Mn	Si	Cr
SK 385-SA	8555	UP 6-GF-55-CG		54		1.3	0.4	16.0
SK 402-S	8555	UP 8-GF-150 / 400-KPZ	150		0.07	6.6	1.0	17.0
SK 410 NiMo-SA	8555	UP 5-GF-40-C		39	0.05	1.0	0.3	12.5
SK 415-SA	8555	UP 5-GF-45-C		42	0.08	0.9	0.4	13.5
SK 420-SA	8555	UP 6-GF-55-C		53	0.27	1.3	0.3	13.5
SK 430C-SA	8555	UP 5-GF-200-C	175		0.04	0.9	0.5	19.5
SK 430 Mo-SA	8555	UP 6-GF-300-C	260		0.25	1.0	0.6	17.9
SK 461C-SA	8555	UP 6-GF-50-C		54	0.26	0.9	0.5	12.2
SK 461-SA	8555	UP 6-GF-45-C		43	0.22	0.9	0.5	13.5
SK 740 L-SA	8555	UP 5-GF-45		33	0.05	1.0	0.7	16.5
SK 742 N-SK	8555	UP 5-GF-45-C		44	0.04	1.2	0.4	13.5

#### Solution example

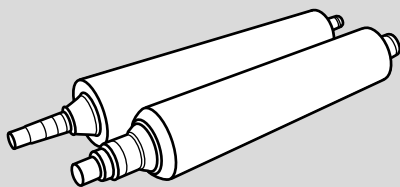

*Continuous casting roller*

SK 742 N-SK

## applications

	Ni	Mo	Nb	W	V	Fe	Co	N	Erosion	Impact	Corrosion	Cavitation	Metal to metal wear	Heat	Page
		0.5				Bal.					■		■		434
	8.0					Bal.				■	■				435
	5.0	0.9				Bal.					■		■		436
	2.1	1.1	0.2		0.3	Bal.					■		■		437
						Bal.					■		■		438
						Bal.					■		■		439
		1.0				Bal.					■		■		440
	0.4	1.4		0.9	1.0	Bal.	1.8				■		■		441
		2.0		0.9	2.0	Bal.	1.8				■		■		442
	3.7	1.7	0.2		0.2	Bal.					■		■		443
	3.3	1.3	0.1		0.15	Bal.		0.06			■		■		444

**SK 385-SA**

stainless steels

**Classifications**

SAW cored wire

DIN 8555

UP 6-GF-55-CG

**Characteristics**

Martensitic alloy designed to resist metal-to-metal wear, corrosion and thermal fatigue.

Microstructure: Chromium carbides in a martensitic matrix with residual austenite

Machinability: Fair with carbide tipped tools

Oxy-acetylene cutting: Cannot be flame cut

Welding flux: Record SA

**Field of use**

Pinch rollers, bending rollers, deflector rollers, looper rollers.

**Typical analysis in %**

Mn	Si	Cr	Mo	Fe
1.3	0.4	16.0	0.5	balance

**Typical mechanical properties**

Hardness as welded: 54 HRC

**Form of delivery and recommended welding parameters**

Wire diameter [mm]	Amperage [A]	Voltage [V]	Stick-out [mm]	Flux-Rate [kg per kg wire]	Travel Speed [cm/min]
3.2	325 – 500	28 – 32	30 – 35	1.1	40 – 50

**SK 402-S**

stainless steels

**Classifications**

SAW cored wire

DIN 8555

UP 8-GF-150 / 400-KPZ

**Characteristics**

Austenitic alloy type 18Cr8Ni7Mn recommended for build up and buffer layer prior to hardfacing. It can also be used for joining of dissimilar metals.

Microstructure: Austenite

Machinability: Good with metallic carbide tipped tools

Oxy-acetylene cutting: Cannot be flame cut

Deposit thickness: As required

Welding flux: Record SA

**Field of use**

Joining of wear plates on shovel buckets, rebuilding of rails, press rams, tramways rail bends.

**Typical analysis in %**

C	Mn	Si	Cr	Ni	Fe
0.07	6.6	1.0	17.0	8.0	balance

**Typical mechanical properties**

Hardness as welded: 150 HB

**Form of delivery and recommended welding parameters**

Wire diameter [mm]	Amperage [A]	Voltage [V]	Stick-out [mm]	Flux-Rate [kg per kg wire]	Travel Speed [cm/min]
3.2	325 – 450	28 – 30	30 – 35	1.1	35 – 45

**SK 410 NiMo-SA**

stainless steels

**Classifications**

SAW cored wire

DIN 8555

UP 5-GF-40-C

**Characteristics**

Alloy depositing a ferritic-martensitic steel containing 13 % Chromium, 5 % Nickel and 1 % Molybdenum designed to resist metal-to-metal wear, corrosion and thermal fatigue fire cracking.

Microstructure: Martensite + 10 % Ferrite

Machinability: Good with carbide tipped tools

Oxy-acetylene cutting: Cannot be flame cut

Deposit thickness: Depends upon application and procedure used

Welding flux: Record SA

**Field of use**

Continuous casting rollers.

**Typical analysis in %**

C	Mn	Si	Cr	Ni	Mo	Fe
0.05	1.0	0.3	12.5	5.0	0.9	balance

**Typical mechanical properties**

Hardness as welded: 39 HRC

**Form of delivery and recommended welding parameters**

Wire diameter [mm]	Amperage [A]	Voltage [V]	Stick-out [mm]	Flux-Rate [kg per kg wire]	Travel Speed [cm/min]
2.4	275 – 450	28 – 30	30 – 35	1.1	35 – 45
3.2	325 – 500	28 – 32	30 – 35	1.1	40 – 50

**SK 415-SA**

stainless steels

**Classifications**

SAW cored wire

DIN 8555

UP 5-GF-45-C

**Characteristics**

Alloy depositing a ferritic-martensitic steel designed to resist metal-to-metal wear, corrosion and thermal fatigue.

Microstructure: Martensite + 10 % Ferrite

Machinability: Good with metallic carbide tipped tools

Oxy-acetylene cutting: Cannot be flame cut

Deposit thickness: Depends upon application and procedure used

Welding flux: Record SA, Record SK

**Field of use**

Continuous casting rollers.

**Typical analysis in %**

C	Mn	Si	Cr	Ni	Mo	Nb	V	Fe
0.08	0.9	0.4	13.5	2.1	1.1	0.2	0.3	balance

**Typical mechanical properties**

Hardness as welded: 42 HRC

**Form of delivery and recommended welding parameters**

Wire diameter [mm]	Amperage [A]	Voltage [V]	Stick-out [mm]	Flux-Rate [kg per kg wire]	Travel Speed [cm/min]
3.2	325 – 500	28 – 32	30 – 35	1.1	40 – 50

**SK 420-SA**

stainless steels

**Classifications**

SAW cored wire

DIN 8555

UP 6-GF-55-C

**Characteristics**

Alloy depositing a martensitic steel containing 13 % Chromium giving a good resistance to metal-to-metal wear and corrosion.

Microstructure: Martensite

Machinability: Good with cubic Boron Nitride tipped tools

Oxy-acetylene cutting: Cannot be flame cut

Deposit thickness: Depends upon application and procedure used

Welding flux: Record SA

**Field of use**

Dredging pump casings, continuous casting rollers.

**Typical analysis in %**

C	Mn	Si	Cr	Fe
0.27	1.3	0.3	13.5	balance

**Typical mechanical properties**

Hardness as welded: 53 HRC

**Form of delivery and recommended welding parameters**

Wire diameter [mm]	Amperage [A]	Voltage [V]	Stick-out [mm]	Flux-Rate [kg per kg wire]	Travel Speed [cm/min]
2.4	275 – 450	28 – 30	30 – 35	1.1	35 – 45
3.2	325 – 500	28 – 32	30 – 35	1.1	40 – 50



**SK 430C-SA**

stainless steels

**Classifications**

SAW cored wire

DIN 8555

UP 5-GF-200-C

**Characteristics**

Alloy depositing a ferritic steel containing 17 % Chromium designed to resist corrosion at high temperatures, particularly in presence of sulphurous gas.

Microstructure: Ferrite and few martensite

Machinability: Very good

Oxy-acetylene cutting: Cannot be flame cut

Deposit thickness: Depends upon application and procedure used

Welding flux: Record SA, Record SK

**Field of use**

Continuous casting rollers situated at the top of the line, valves, steam and gas turbine parts, valve seats.

**Typical analysis in %**

C	Mn	Si	Cr	Fe
0.04	0.9	0.5	19.5	balance

**Typical mechanical properties**

Hardness as welded: 175 HB

**Form of delivery and recommended welding parameters**

Wire diameter [mm]	Amperage [A]	Voltage [V]	Stick-out [mm]	Flux-Rate [kg per kg wire]	Travel Speed [cm/min]
2.4	250 – 350	28 – 30	30 – 35	1.1	35 – 45
2.8	300 – 400	28 – 30	30 – 35	1.1	35 – 45
3.2	325 – 500	28 – 32	30 – 35	1.1	40 – 50

**SK 430 Mo-SA**

stainless steels

**Classifications**

SAW cored wire

DIN 8555

UP 6-GF-300-C

**Characteristics**

Alloy depositing a ferritic steel containing 17 % Chromium enhanced with Molybdenum addition designed to resist corrosion at high temperatures, particularly in presence of sulphurous gas.

Microstructure: Ferrite and few martensite

Machinability: Good

Oxy-acetylene cutting: Cannot be flame cut

Deposit thickness: Depends upon application and procedure used

Welding flux: Record SA, Record SK

**Field of use**

Continuous casting rollers, valves, steam and gas turbine parts, valve seats.

**Typical analysis in %**

C	Mn	Si	Cr	Mo	Fe
0.25	1.0	0.6	17.9	1.0	balance

**Typical mechanical properties**

Hardness as welded: 260 HB

**Form of delivery and recommended welding parameters**

Wire diameter [mm]	Amperage [A]	Voltage [V]	Stick-out [mm]	Flux-Rate [kg per kg wire]	Travel Speed [cm/min]
3.2	325 – 500	28 – 32	30 – 35	1.1	40 – 50

**SK 461C-SA**

stainless steels

**Classifications**

SAW cored wire

DIN 8555

UP 6-GF-50-C

**Characteristics**

Alloy depositing a ferritic-martensitic steel designed to resist metal-to-metal wear, corrosion and thermal fatigue fire cracking.

Microstructure: Martensite + max 20 % ferrite

Machinability: Good with metallic carbide tipped tools

Oxy-acetylene cutting: Cannot be flame cut

Deposit thickness: Depends upon application and procedure used

Welding flux: Record SA, Record SK

**Field of use**

Continuous casting rollers.

**Typical analysis in %**

C	Mn	Si	Cr	Ni	Mo	Co	W	V	Fe
0.26	0.9	0.5	12.2	0.4	1.4	1.8	0.9	1.0	balance

**Typical mechanical properties**

Hardness as welded: 54 HRC

**Form of delivery and recommended welding parameters**

Wire diameter [mm]	Amperage [A]	Voltage [V]	Stick-out [mm]	Flux-Rate [kg per kg wire]	Travel Speed [cm/min]
2.4	250 – 350	28 – 30	30 – 35	1.1	35 – 50
3.2	325 – 500	28 – 32	30 – 35	1.1	40 – 50

**SK 461-SA**

stainless steels

**Classifications**

SAW cored wire

DIN 8555

UP 6-GF-45-C

**Characteristics**

Alloy depositing a ferritic-martensitic steel designed to resist metal-to-metal wear, corrosion and thermal fatigue fire cracking.

Microstructure: Martensite + 20 % ferrite (second layer)

Machinability: Good with metallic carbide tipped tools

Oxy-acetylene cutting: Cannot be flame cut

Deposit thickness: Depends upon application and procedure used

Welding flux: Record SA, Record SR

**Field of use**

Continuous casting rollers.

**Typical analysis in %**

C	Mn	Si	Cr	Mo	Co	W	V	Fe
0.22	0.9	0.5	13.5	2.0	1.8	0.9	2.0	balance

**Typical mechanical properties**

Hardness as welded: 43 HRC

**Form of delivery and recommended welding parameters**

Wire diameter [mm]	Amperage [A]	Voltage [V]	Stick-out [mm]	Flux-Rate [kg per kg wire]	Travel Speed [cm/min]
2.4	275 – 450	28 – 30	30 – 35	1.1	35 – 45
3.2	325 – 500	28 – 32	30 – 35	1.1	40 – 50

**Classifications**

SAW cored wire

DIN 8555

UP 5-GF-45

**Characteristics**

Alloy depositing a ferritic-martensitic steel in two layers on a CrMo steel containing 0.4 % C. It has been designed to resist metal-to-metal wear, corrosion and thermal fatigue fire cracking.

Microstructure: Martensite + ferrite

Machinability: Good with carbide tipped tools

Oxy-acetylene cutting: Cannot be flame cut

Deposit thickness: Depends upon application and procedure used

Welding flux: Record SA

**Field of use**

Continuous casting rollers.

**Typical analysis in %**

C	Mn	Si	Cr	Ni	Mo	Nb	V	Fe
0.05	1.0	0.7	16.5	3.7	1.7	0.2	0.2	balance

**Typical mechanical properties**

Hardness as welded: 33 HRC

**Form of delivery and recommended welding parameters**

Wire diameter [mm]	Amperage [A]	Voltage [V]	Stick-out [mm]	Flux-Rate [kg per kg wire]	Travel Speed [cm/min]
2.4	275 – 450	28 – 30	30 – 35	1.1	35 – 45
3.2	325 – 450	28 – 30	25 – 35	1.1	30 – 50

**SK 742 N-SK**

stainless steels

**Classifications**

SAW cored wire

DIN 8555

UP 5-GF-45-C

**Characteristics**

Alloy depositing a ferritic-martensitic steel with addition of Nitrogen designed to enhance the resistance to thermal fatigue and intragranular corrosion by reducing the formation of carbides at grain boundaries.

Microstructure: Martensite + 10 % Ferrite

Machinability: Good with metallic carbide tipped tools

Oxy-acetylene cutting: Cannot be flame cut

Deposit thickness: Depends upon application and procedure used

Welding flux: Record SK

**Field of use**

Continuous casting rollers.

**Typical analysis in %**

C	Mn	Si	Cr	Ni	Mo	Nb	V	N	Fe
0.04	1.2	0.4	13.5	3.3	1.3	0.1	0.15	0.06	balance

**Typical mechanical properties**

Hardness as welded: 44 HRC

**Form of delivery and recommended welding parameters**

Wire diameter [mm]	Amperage [A]	Voltage [V]	Stick-out [mm]	Flux-Rate [kg per kg wire]	Travel Speed [cm/min]
2.4	275 – 450	28 – 30	30 – 35	1.1	35 – 45
2.8	300 – 400	28 – 30	30 – 35	1.1	35 – 45
3.2	325 – 500	28 – 32	30 – 35	1.1	40 – 50

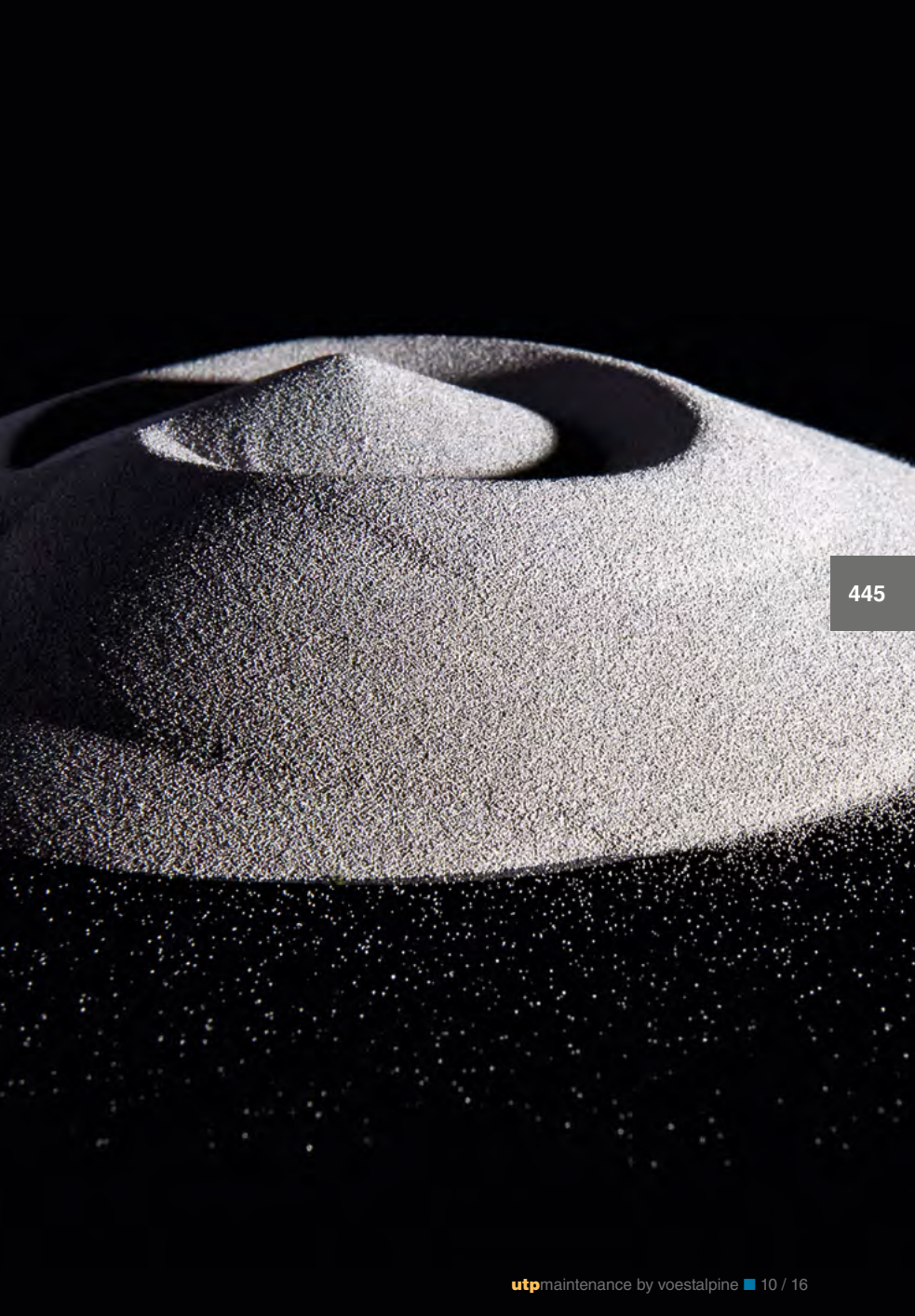

445

## SAW product selection table

Cored wire	Flux		
	RECORD SA	RECORD SK	RECORD SR
SK 219-S	■		
SK AP-S	■		
SK 20CrMo-SA	■		
SK 242-S	■		
SK 258 NbC-SA	■		■
SK 258L-SA	■		■
SK 258-SA	■		■
SK 263-SA	■		■
SK 350-S	■		
SK BU-S	■		■
SK CrMo15-SA	■		
SK SOUDOCORE-D-SA	■		
SK 255-S	■		
SK A45-S	■		
SK 385-SA	■		
SK 402-S	■		
SK 410 NiMo-SA	■		
SK 415-SA	■		
SK 420-SA	■		
SK 430 Mo-SA	■	■	
SK 430C-SA	■	■	
SK 461-CSA	■	■	
SK 461-SA	■	■	
SK 740L-SA	■	■	
SK 742 N-SK		■	
SK D35-S	■		■
Page	407	408	409



## RECORD SA

### Classifications

SAW flux

EN 760

SA FB 3

### Description

Highly basic agglomerated flux designed for hardfacing with cored wires or solid wires.

Very good slag removal even at high welding intensity levels.

Suitable with DC or AC.

### General characteristics

Current: DC (+ and -) and AC – 1000 A max.

Basicity index: 3.4 (according to Bonizewski; calculated in mole %)

Grain size: 0.4 – 1.4 mm (14 x 40 No. ASTM)

Apparent density: 0.85

Consumption: 1.1 (kg fused flux / kg wire)

Redrying: 1 to 2 hours at 350 + / - 50 °C

### Packing

25 kg (pail)

25 kg (bag)

**RECORD SK****Classifications**

SAW flux

EN 760

SA FB 3

**Description**

Special agglomerated flux for hardfacing with high Nitrogen containing flux cored wire as SK 742N-SK.

Very good slag removal and weld bead appearance make this flux particularly suitable for the hardfacing of continuous casting rolls.

**General characteristics**

Current: DC (+) – 1000 A max.

Basicity index: 3.4 (according to Bonizewski; calculated in mole %)

Grain size: 0.4 – 1.4 mm (14 x 40 No. ASTM)

Apparent density: 0.8

Consumption: 1.1 (kg fused flux / kg wire)

Redrying: 1 to 2 hours at 350 + / – 50 °C

**Packing**

25 kg (bag)

## RECORD SR

### Classifications

SAW flux

EN 760

SA FB 3

### Description

Highly basic agglomerated flux for hardfacing with solid and cored wires.

Suitable with DC and AC welding currents.

Easy slag removability and deposits free from porosities.

Very low hydrogen level and low hygroscopicity.

### General characteristics

Current: DC (+ and -) and AC – 1000 A max.

Basicity index: 2.0 (according to Bonizewski; calculated in mole %)

Grain size: 0.4 – 1 mm (14 x 60 No. ASTM)

Apparent density: 1.0

Consumption: 1.1 (kg fused flux / kg wire)

Redrying: 1 to 2 hours at 350 + / - 50 °C

### Packing

25 kg (bag)



## List of contents

### Cladding

<b>Description of (SAW) submerged arc strip cladding</b>	<b>452</b>
<b>Description of (ESW) electro slag strip cladding</b>	<b>453</b>
<b>Strip cladding</b>	<b>454</b>
1. Unalloyed and low alloyed steels	454
2. Stainless steels hardfacing and buffering	458
3. Cobalt alloys	462
<b>Strip cladding equipment</b>	<b>464</b>
1. Strip cladding nozzles	464
2. Magnetic steering device	465

## Description of (SAW) submerged arc strip cladding

- ① Strip feed & regulation
- ② Flux feed hopper
- ③ Base metal
- ④ Solidified slag
- ⑤ Liquid slag
- ⑥ Flux feed hopper
- ⑦ Direction of the welding

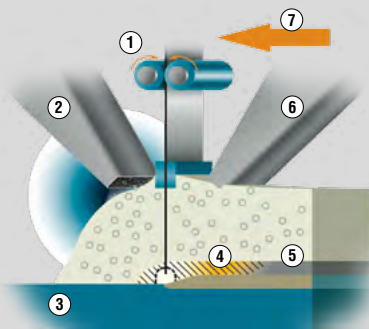

Submerged arc (SAW) strip cladding can easily be compared to submerged arc welding with wire. You “only” have to replace the wire by a strip. The strip is fed through two driving rolls. The current is transferred to the strip by two contact shoes, which have approximately the same width of the strip and are especially designed for optimal current transfer to the strip. The flux is fed from two sides by two flux hoppers. The bottom of the strip is therefore totally submerged by flux. The energy needed to melt the strip is provided by an electric arc. The flux is also melted and a liquid slag forms on the top of the liquid metal. As the process progresses, the slag solidifies and detaches automatically.

- High deposition rate
- High quality weld metal
- Easy slag removal

## Description of (ESW) electro slag strip cladding

- ① Strip feed & regulation
- ② Flux feed hopper
- ③ Base metal
- ④ Solidified slag
- ⑤ Liquid slag
- ⑥ Direction of the welding

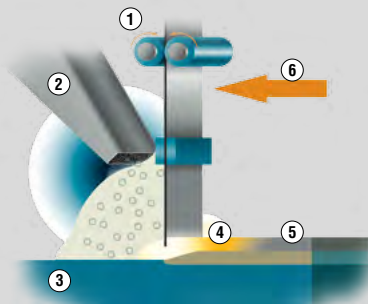

The electroslag welding process (ESW) slightly differs from the SAW strip cladding process in the fact that the flux is fed only from one side and that there is no electric arc. The liquid slag is electroconductive and conducts the energy required to melt the strip and flux by Joule-effect. When the strip arrives in the welding pool, it melts. As the slag solidifies, it forms a protective layer on the hot metal and then detaches automatically.

- Lower penetration
- Lower dilution (down to 7%)
- High current density resulting to higher deposition rate (up to 50 kg / h)
- Open weld pool
- Special high speed fluxes (up to 45 cm / min)
- High deposition rate (up to 1.2 m<sup>2</sup> / h)
- Perfect overlap and very flat bead surface with magnetic steering
- Low flux consumption

## Strip cladding

### 1. Unalloyed and low alloyed steels

Type of deposited alloy	Welding process	Layer	Type of strip (60 x 0.5 mm)	Type of flux	Chemical analyses		
			Soudotape	+ Record	C	Mn	
Unalloyed steel	SAW	1.+2. L: strip	A		0.025	0.2	
		2. L: deposit	A	S 46 T	0.055	1.0	
		1.+2. L: strip	A		0.025	0.2	
		2. L: deposit	A	RT 146	0.055	1.0	
0.5 Mo	SAW	1.+2. L: strip	A		0.025	0.2	
		2. L: deposit	A	SMoTW	0.042	1.0	
1 Ni - 0.5 Mo	SAW	1.+2. L: strip	A		0.025	0.2	
		2. L: deposit	A	NiMo15T	0.116	0.7	
1.5 Cr - 0.5 Mo	SAW	1.+2.+3. L: strip	A		0.025	0.2	
		2. L: deposit	A	CrMo15TW	0.060	0.4	
		3. L: deposit	A	CrMo15TW	0.036	0.5	
2Cr - 0.5 Mo	SAW	1.+2.+3. L: strip	A		0.025	0.2	
		1. L: deposit	A	CrMo25TW	0.140	0.6	
		2. L: deposit	A	CrMo25TW	0.110	0.7	
		3. L: deposit	A	CrMo25TW	0.080	0.6	
3Cr - 0.5 Mo	SAW	1.+2.+3. L: strip	A		0.025	0.2	
		3. L: deposit	A	RT 250	0.080	0.7	
5Cr - 0.9 Mo	SAW	1.+2.+3. L: strip	A		0.025	0.2	
		2. L: deposit	A	RT 350	0.070	0.3	
		3. L: deposit	A	RT 350	0.080	0.3	



on a 0.2% C plate (typical) (weight -%)									Welding parameters (60 x 0.5 mm)			Layer thickness	Deposition rate	
	Si	Cr	Ni	Mo	Nb	Fe	Others	Hardness	A	V	cm/min	mm	kg/h	m <sup>2</sup> /h
	0.01					bal.								
	0.5					bal.		150 HB	1150	28	15	4.4	22	0.63
	0.01					bal.								
	0.5					bal.		150 HB	1150	28	15	4.4	22	0.63
	0.01					bal.								
	0.6			0.6		bal.			900	26	18	3.0	17	0.72
	0.01					bal.								
	0.5		0.9	0.5		bal.		210 HB	1100	25	13	4.2	21	0.63
	0.01					bal.								
	0.3	1.3		0.6		bal.		240 HB	800	24	17	3.5	15	0.55
	0.3	1.3		0.6		bal.		235 HB	800	24	17	3.5	15	0.55
	0.01					bal.								
	0.4	1.4		0.5		bal.		240 HB	650	28	13	4	12	0.39
	0.5	1.7		0.6		bal.		240 HB	650	28	13	4	12	0.39
	0.5	1.9		0.6		bal.		240 HB	650	28	13	4	12	0.39
	0.01					bal.								
	0.7	3.0		0.4		bal.		290 HB	1275	24	15	4.4	24	0.69
	0.01					bal.								
	0.3	4.6		0.8		bal.		325 HB	900	28	13	3.8	17	0.57
	0.3	5.0		0.9		bal.		325 HB	900	28	13	3.8	17	0.57

1 inch = 25.4 mm / 1 lbs = 0.4536 kg

## Strip cladding

### 1. Unalloyed and low alloyed steels

Type of deposited alloy	Welding process	Layer	Type of strip (60 x 0.5 mm)	Type of flux	Chemical analyses		
			Soudotape	+ Record	C	Mn	
0.4C - 6Cr - 0.7Mo	SAW	1.+2.+3. L: strip	A		0.025	0.2	
		1. L: deposit	A	RT 600	0.290	0.6	
		2. L: deposit	A	RT 600	0.330	0.4	
		3. L: deposit	A	RT 600	0.340	0.3	
0.2C - 6Cr - 1.5Mo - 1.5W	SAW	1.+2.+3. L: strip	258		0.330	1.1	
		2. L: deposit	258	RT 159	0.250	1.0	
		3. L: deposit	258	RT 159	0.250	1.0	
	ESW	1.+2. L: strip	258		0.330	1.1	
		1. L: deposit	258	EST 122	0.250	1.0	
		2. L: deposit	258	EST 122	0.250	1.0	

### Solution examples

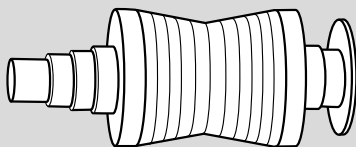

*Pinch roller*

Soudotape 258 + Record RT 159

on a 0.2% C plate (typical) (weight -%)									Welding parameters (60 x 0.5 mm)			Layer thickness	Deposition rate	
	Si	Cr	Ni	Mo	Nb	Fe	Others	Hardness	A	V	cm/min	mm	kg/h	m <sup>2</sup> /h
	0.01					bal.								
	0.7	3.4		0.5		bal.		45 HRC	950	27	17	4	18	0.57
	0.8	4.6		0.6		bal.		50 HRC	950	27	17	4	18	0.57
	0.9	5.3		0.7		bal.		55 HRC	950	27	17	4	18	0.57
	0.4	6.8	0.4	1.7		bal.	W 1.7							
	0.5	6.4	0.3	1.3		bal.	W 1.55	45 HRC	750	28	12	3.2	14	0.56
	0.5	6.6	0.3	1.6		bal.	W 1.6	50 HRC	750	28	12	3.2	14	0.56
	0.4	6.8	0.4	1.7		bal.	W 1.7							
	0.5	5.4	0.2	1.3		bal.	W 1.35	45 HRC	1250	24	16	5	24	0.60
	0.6	6.4	0.3	1.5		bal.	W 1.55	45 HRC	1250	24	16	4.8	24	0.62

1 inch = 25.4 mm / 1 lbs = 0.4536 kg

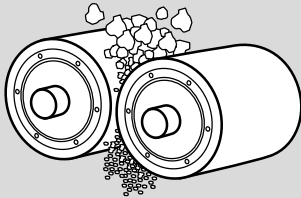

*Carbon crusher*

Soudotape A + Record SMoTW

# Strip cladding

## 2. Stainless steels hardfacing and buffering

Type of deposited alloy	Welding process	Layer	Type of strip (60 x 0.5 mm)	Type of flux	Chemical analyses		
			Soudotape	+ Record	C	Mn	
410	ESW *	1. L: strip	430		0.045	0.4	
		1. L: deposit	430	EST 122	0.055	0.4	
420	SAW	1.+2.+3. L: strip	420		0.330	0.4	
		1. L: deposit	420	RT 159	0.190	0.2	
		2. L: deposit	420	RT 159	0.200	0.2	
		3. L: deposit	420	RT 159	0.200	0.2	
	ESW	1.+2. L: strip	420		0.330	0.4	
		1. L: deposit	420	EST 426	0.290	0.4	
		2. L: deposit	420	EST 426	0.310	0.3	
420 Mo	ESW	1.+2.+3. L: strip	420		0.330	0.4	
		1. L: deposit	420	EST 423	0.270	0.4	
		2. L: deposit	420	EST 423	0.280	0.2	
		3. L: deposit	420	EST 423	0.290	0.3	
14Cr2Ni1Mo	SAW	1.+2. L: strip	430		0.045	0.4	
		2. L: deposit	430	RT 179	0.071	0.1	
410 NiMo	SAW	1.+2.+3. L: strip	430		0.045	0.4	
		1. L: deposit	430	RT 152	0.068	0.6	
		2. L: deposit	430	RT 152	0.037	0.5	
		3. L: deposit	430	RT 152	0.033	0.5	
	ESW	1.+2.+3. L: strip	430		0.045	0.4	
		1. L: deposit	430	EST 452	0.062	0.5	
2. L: deposit		430	EST 452	0.052	0.3		
		3. L: deposit	430	EST 452	0.045	0.3	
13Cr4Ni1Mo	SAW	1.+2. L: strip	430		0.045	0.4	
		1. L: deposit	430	RT 162	0.054	0.6	
		2. L: deposit	430	RT 162	0.039	0.5	
410 NiMoNbV	SAW	1.+2.+3. L: strip	430		0.045	0.4	
		1. L: deposit	430	RT 742	0.085	0.4	
		2. L: deposit	430	RT 742	0.090	0.3	
		3. L: deposit	430	RT 742	0.090	0.3	

\*single layer

on a 0.2% C plate (typical) (weight-%)									Welding parameters (60 x 0.5 mm)			Layer thickness	Deposition rate	
	Si	Cr	Ni	Mo	Nb	Fe	Others	Hardness	A	V	cm/min	mm	kg/h	m <sup>2</sup> /h
	0.3	16.2	0.1			bal.								
	0.5	12.9				bal.		280 HB	1250	24	20	4.5	24	0.67
	0.4	13.6				bal.								
	0.7	9.2				bal.		45 HRC	750	28	12	3.8	14	0.47
	0.8	11.6				bal.		45 HRC	750	28	12	3.6	14	0.50
	0.8	12.2				bal.		50 HRC	750	28	12	3.5	14	0.51
	0.4	13.6				bal.								
	0.4	10.6				bal.		50 HRC	1400	24	24	4.4	27	0.76
	0.2	12.6				bal.		50 HRC	1400	24	24	4.2	27	0.80
	0.4	13.6				bal.								
	0.2	10.5		1.4		bal.		50 HRC	1250	24	17	4.3	24	0.70
	0.1	12.8		1.8		bal.		50 HRC	1250	24	17	4.2	24	0.71
	0.1	12.9		1.8		bal.		50 HRC	1250	24	17	4.2	24	0.71
	0.3	16.2	0.1	0.02		bal.							0	
	1.2	17.3	0.1			bal.			900	24	15	4.0	17	0.54
	0.3	16.2	0.1	0.02		bal.								
	0.6	12.2	2.9	0.7		bal.		405 HB	650	27	13	3.5	12	0.44
	0.9	13.9	3.8	0.9		bal.		390 HB	650	27	13	3.5	12	0.44
	0.9	14.0	3.8	0.9		bal.		385 HB	650	27	13	3.5	12	0.44
	0.3	16.2	0.1	0.02		bal.								
	0.4	11.7	3.0	0.4		bal.		40 HRC	1100	24	16	4	21	0.66
	0.4	14.1	3.3	0.4		bal.		40 HRC	1100	24	16	3.5	21	0.75
	0.4	14.8	3.6	0.5		bal.		40 HRC	1100	24	16	3.5	21	0.75
	0.3	16.2	0.1	0.02		bal.								
	1.0	13.1	4.0	0.7		bal.		40 HRC	650	27	13	3	12	0.52
	1.1	16.2	5.3	0.9		bal.		35 HRC	650	27	13	3	12	0.52
	0.3	16.2	0.1	0.02		bal.								
	0.8	12.0	2.0	0.9	0.1	bal.	V 0.10	40 HRC	800	27	13	3	15	0.64
	0.9	13.0	2.3	1.0	0.1	bal.	V 0.13	40 HRC	800	27	13	3	15	0.64
	0.9	13.5	2.4	1.0	0.2	bal.	V 0.15	40 HRC	800	27	13	3	15	0.64

1 inch = 25.4 mm / 1 lbs = 0.4536 kg

## Strip cladding

### 2. Stainless steels hardfacing and buffering

Type of deposited alloy	Welding process	Layer	Type of strip (60x0.5 mm)	Type of flux	Chemical analyses		
			Soudotape	+ Record	C	Mn	
12Cr6Ni2Mo	SAW	1.+2.+3. L: strip	430L		0.015	0.4	
		1. L: deposit	430L	RT 168	0.075	0.4	
		2. L: deposit	430L	RT 168	0.027	0.3	
		3. L: deposit	430L	RT 168	0.017	0.2	
17Cr	SAW	1.+2. L: strip	430		0.045	0.4	
		1. L: deposit	430	RT 179	0.060	0.4	
		2. L: deposit	430	RT 179	0.071	0.5	
	ESW	1.+2. L: strip	430		0.045	0.4	
		1. L: deposit	430	EST 127	0.055	0.4	
		2. L: deposit	430	EST 127	0.050	0.4	
18Cr 8Ni 6Mn	ESW	1.+2. L: strip	308L		0.013	1.7	
		1. L: deposit	308L	EST 307	0.079	4.9	
		2. L: deposit	308L	EST 307	0.071	5.3	
18Cr 10Ni 4.5Mn	ESW*	1. L: strip	309L		0.012	1.8	
		1. L: deposit	309L	EST 307	0.088	4.3	

\*single layer

#### Solution examples

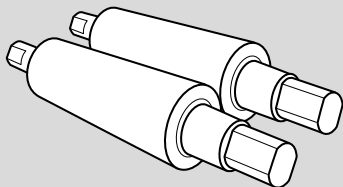

*Continuous casting roller*

Soudotape 430 + Record RT 162

on a 0.2% C plate (typical) (weight-%)								Welding parameters (60 x 0.5 mm)			Layer thickness	Deposition rate		
	Si	Cr	Ni	Mo	Nb	Fe	Others	Hardness	A	V	cm/min	mm	kg/h	m <sup>2</sup> /h
	0.3	16.4	0.1	0.02		bal.								
	0.6	9.5	3.9	2.0		bal.			800	26	16	2.8	15	0.68
	0.7	12.1	4.7	2.5		bal.			800	26	16	2.8	15	0.68
	0.8	12.9	5.2	2.6		bal.		35 HRC	800	26	16	2.8	15	0.68
	0.3	16.2	0.1			bal.								
	1.0	15.0				bal.			900	24	15	4.1	17	0.53
	1.1	17.3				bal.			900	24	15	4.1	17	0.53
	0.3	16.2	0.1			bal.								
	0.5	14.5				bal.			1250	24	20	4.5	24	0.67
	0.6	17.2				bal.			1250	24	20	4.5	24	0.67
	0.4	20.3	10.4			bal.			.					
	0.5	17.7	8.8			bal.			1250	24	17	4.5	24	0.67
	0.6	18.6	9.2			bal.			1250	24	17	4.5	24	0.67
	0.4	23.7	13.3			bal.			.					
	0.4	19.3	10.7			bal.			1250	24	17	4.5	24	0.67

1 inch = 25.4 mm / 1 lbs = 0.4536 kg

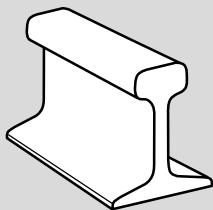

*Rail*

Soudotape 309L + Record EST 307

## Strip cladding

### 3. Cobalt alloys

Type of deposited alloy	Welding process	Layer	Type of strip (60 x 0.5 mm)	Type of flux	Chemical analyses		
			Soudotape	+ Record	C	Mn	
Cobalt alloy 6	ESW	1.+2. L: strip	SCoCr 6		1.100	0.6	
		1. L: deposit	SCoCr 6	EST 126	1.000	0.4	
		2. L: deposit	SCoCr 6	EST 126	1.050	0.5	
Cobalt alloy 21	ESW	1.+2. L: strip	SCoCr 21		0.250	0.4	
		1. L: deposit	SCoCr 21	EST 126	0.300	0.2	
		2. L: deposit	SCoCr 21	EST 126	0.250	0.4	



on a 0.2% C plate (typical) (weight-%)								Welding parameters (60 x 0.5 mm)			Layer thickness	Deposition rate		
	Si	Cr	Ni	Mo	Co	Fe	Others	Hardness	A	V	cm/min	mm	kg/h	m <sup>2</sup> /h
	0.1	31.5	2.1	0.8	bal.		W 5							
	0.3	28.5	0.0	0.0	bal.	6.0	W 4.8	40 HRC	1000	26	10	5	19.2	0.48
	0.3	29.0	0.0	0.0	bal.	3.0	W 4.5	42 HRC	1000	26	10	4.5	19.2	0.53
	0.5	27.2	3.3	5.5	bal.									
	0.4	24.5	1.5	5.3	bal.	10.0		30 HRC	1000	26	10	5	19.2	0.48
	0.5	25.7	3.0	5.3	bal.	3.0		31 HRC	1000	26	10	4.5	19.2	0.53

1 inch = 25.4 mm / 1 lbs = 0.4536 kg

## Strip cladding equipment

### 1. Strip cladding nozzles

Type	SK 30-ES2-75	SK 60 ES3-207	SK 125 ES1-300	SK 180 ES1-315*
Allowed strip width [mm]	15 - 20 - 30	30 - 60	30 - 60 - 90 - 120	120 - 150 - 180
Min. interval diameter [mm]				
Longitudinal **	220	380	550	700
Circular**	350	550	700	900
Dimensions [mm]	125x165x280	265x280x270	300x450x270	500x370x350
Weight [kg]	4	10	18	36

\* Only available on request

inch = 25.4 mm / 1 lbs = 0.4536 kg

\*\* May vary according drive motor and positioning equipment

### Strip cladding head designed for both submerged arc and electroslag strip cladding.



*SK 30-ES2-75*

This nozzle is designed for electroslag and submerged arc strip cladding with strip sizes smaller than 30 mm. The small size of this nozzle makes it possible to weld on the inside of tubes with an internal diameter of 350 mm when welding circular and even 220 mm when welding longitudinally.



*SK 60 ES3-207*

This nozzle is designed for electroslag and submerged arc strip cladding with strip sizes of 30 mm and 60 mm. The minimal internal diameter necessary for welding with this nozzle is 550 mm when welding circular and 380 mm when welding longitudinally.

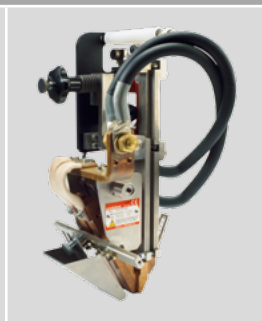

*SK 125-ESI-300*

This nozzle is designed for electroslag and submerged arc strip cladding with strip sizes of 30 mm, 60 mm, 90 mm and 120 mm. The minimal internal diameter necessary for welding with this nozzle is 700 mm when welding circular and 550 mm when welding longitudinally.

## Strip cladding equipment

### 2. Magnetic steering device

Type	SK CED 1 1370 C22	SK CED 1 1370 C11
Input voltage	230 V	110 V
Frequency	50 Hz	60 Hz



SK CED 1 1370 C22 • SK CED 1 1370 C11

## List of contents

### Thermal spraying

<b>Description of the thermal spraying process</b>	<b>467</b>
<b>Powders</b>	<b>468</b>
1. SIMmelt™ – Powders for simultaneous meltdown	468
2. SUBmelt™ – Powders for subsequent melting	469
3. COLDMelt™ – Powders without melting (cold process)	470
<b>Description of the arc spraying with flux-cored wires process</b>	<b>471</b>
<b>Cored wires</b>	<b>472</b>
1. High alloyed steels	472
2. Nickel alloys	477
<b>Description of the plasma transferred arc process</b>	<b>486</b>
<b>Powders</b>	<b>487</b>
1. PLASweld™ – Powders for hard facing	487

## Description of the thermal spraying process

- ① Acetylene / Oxygen
- ② Powder container
- ③ Burner nozzle
- ④ Conveying gas / Powder
- ⑤ Acetylene / Oxygen – Flame and spray particles
- ⑥ Workpiece

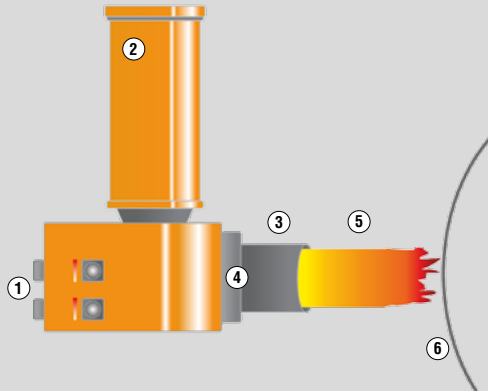

In powder flame spraying, the spray material, in powder form, is melted with an oxy-fuel gas flame, accelerated towards a component by the combustion gases and sprayed on to the surface of the component. Metallic, oxide ceramic, carbide and plastic powders can be processed using spray guns specifically designed for those materials. Spray guns that frequently take the form of manual torches, preferably using acetylene as a fuel gas because of its high flame temperature, are chosen for metallic alloys based on nickel, iron or cobalt. The powder particles, which are partially melted by the flame, deform on impact with the surface of the component and are deposited there to form a spray coating with a lamellar structure. The main areas of application for thermal coatings are corrosion protection and wear protection.

## Powders

### 1. SIMmelt™ – Powders for simultaneous meltdown

#### SIMmelt™ - Powder description

Powders for flame spraying with simultaneous melting

Self fluxing alloys

Powder types based on NiBSi + C + Cr + Co + Cu + tungsten carbide

#### SIMmelt™ - Powder characterization

Alloyed metal powder (some with hard additives),

Round grains (matrix)

Smooth surface

Gas atomized (except hard material additives)

Typical grain size: – 106+20 micron, adjusted to the torch

Spraying layer hardness ~ 150 HV up to >60 HRC

Product name	Grain size	Chem. composition	Hardness
SIMmelt™ Cobalt45	– 106+20 µm	CoCrNiWFeSiB	400 – 460 HV
SIMmelt™ NiBas22	– 106+20 µm	NiCuBSi	170 – 240 HV
SIMmelt™ NiBas25	– 106+20 µm	NiBSi	205 – 260 HV
SIMmelt™ NiBas25F	– 53+20 µm	NiBSi	190 – 260 HV
SIMmelt™ NiBas30	– 106+20 µm	NiBSi	260 – 310 HV
SIMmelt™ NiBas40	– 106+20 µm	NiCrBSiFe	40 HRC
SIMmelt™ NiBas50	– 106+20 µm	NiCrBSiFe	50 HRC
SIMmelt™ NiBas60	– 106+20 µm	NiCrBSiFe	60 HRC
SIMmelt™ NiBasW35	– 106+20 µm	NiCrBSiFe+WSC	Matrix 60 HRC
SIMmelt™ NiBasW55	– 106+20 µm	NiCrCoBSiFe+WSC	Matrix 60 HRC
SIMmelt™ NiBasW60	– 106+20 µm	NiCrBSiFe+WSC	Matrix 60 HRC
SIMmelt™ NiBasW70	– 150+20 µm	NiCrBSi+WSC	Matrix 60 HRC
SIMmelt™ NiBasW605	– 106+20 µm	NiCrBSi+WSC	Matrix 60 HRC

#### Solution examples

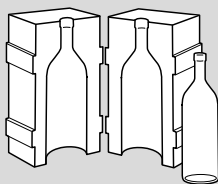

*Bottle mold*

SIMmelt™ NiBas30

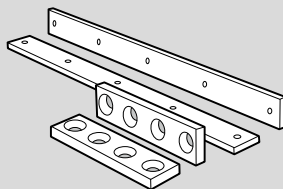

*Shear blade*

SIMmelt™ NiBas50

## Powders

### 2. SUBmelt™ – Powders for subsequent melting

#### SUBmelt™ - Powder description

Powders for flame spraying and subsequent melting

Self fluxing alloys

Powders types based NiCrBSi and tungsten carbide

#### SUBmelt™ - Powder characterization

Alloyed metal powders (some with hard additives)

Round grains (matrix)

Smooth surface

Gas atomized (except hard material additives)

Typical grain size: – 125 + 45 microns

Spray coating hardness ~200 HV to > 60 HRC

Product name	Grain size	Chem. composition	Hardness
SUBmelt™ NiBas40	– 125 + 36 µm	NiCrBSiFe	40 HRC
SUBmelt™ NiBas50	– 125 + 45 µm	NiCrBSiFe	50 HRC
SUBmelt™ NiBas56	– 125 + 45 µm	NiCrBSiFeCuMo	56 HRC
SUBmelt™ NiBas60	– 125 + 45 µm	NiCrBSiFe	60 HRC
SUBmelt™ NiBasW35	– 125 + 45 µm	NiCrBSiFe+WSC	Matrix 60 HRC
SUBmelt™ NiBasW50	– 125 + 45 µm	NiCrBSiFe+WSC	Matrix 60 HRC
SUBmelt™ NiBasW60	– 125 + 45 µm	NiCrBSiFe+WSC	Matrix 60 HRC

#### Solution examples

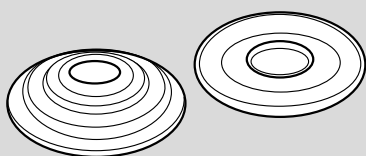

*Valve disk*

SUBmelt™ NiBas40

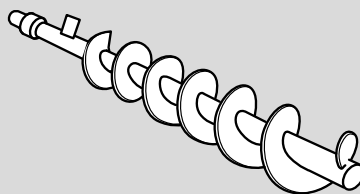

*Screw conveyor*

SUBmelt™ NiBas60

## Powders

### 3. COLDMelt™ – Powders without melting (cold process)

#### COLDMelt™ - Powder description

Powder for thermal spraying without melting (cold process)

Metal alloys, hard alloys, hard material additives (usually with bond layer)

#### COLDMelt™ - Powder characterization

Metal or metal alloyed (some with hard additives)

Round grains (gas atomized)

Smooth surface

Spattered grain, uniform grain structure, water atomized (except for hard material additives)

Typical grain size: – 125 + 36 microns

Product name	Grain size	Chem. composition	Hardness
COLDMelt™ Base 17	– 106 + 36 µm	NiAl	150 – 190 HV
COLDMelt™ Base 20	– 106 + 45 µm	NiAlMo	170 – 240 HV
COLDMelt™ Zn	– 125 µm	Zn	23 HB
COLDMelt™ Ni37	– 106 + 36 µm	NiCrBSiFeAl	350 – 380 HV
COLDMelt™ CuAl	– 120 + 36 µm	CuAl	130 HV
COLDMelt™ NiW15	– 125 + 20 µm	NiCrBSiFeAl+WSC	Matrix 400 HV
COLDMelt™ stainless 18	– 106 + 36 µm	FeCrNiMo	180 HV
COLDMelt™ Fe31	– 125 + 45 µm	FeCrNi	260 – 350 HV
COLDMelt™ OneStep 16	– 106 + 45 µm	NiCrAlMoFe	170 HV

#### Solution examples

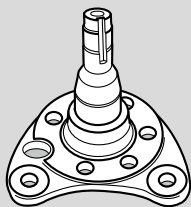

*Axle journal*

COLDMelt™ CuAl

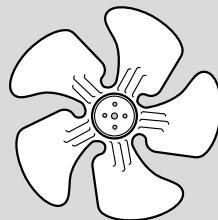

*Fan vane*

COLDMelt™ NiW15



## Description of the arc spraying with flux-cored wires process

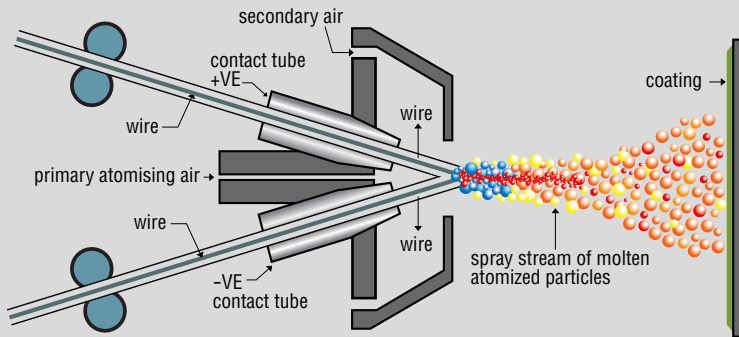

Arc Spraying is the highest productivity thermal spraying process. A DC electric arc is struck between two continuous consumable wire electrodes that form the spray material. Compressed gas [usually air] atomizes the molten spray material into fine droplets and propels them towards the substrate. The process is simple to operate and can be used either manually or in an automated manner.

## Cored wires

### 1. High alloyed steels

Product name	Alloy type	Low stress abrasion	High stress abrasion	Erosion	Impact	Corrosion	Cavitation	Metal to metal wear	Heat	Page
SK 235-M	High alloyed steels		■			■				473
SK 255-M	High alloyed steels		■							474
SK 420-M	High alloyed steels					■				475
SK 848-M	High alloyed steels					■			■	476

**Characteristics and field of use**

SK 235-M is a cored wire developed for arc spraying. This material produces a hard, abrasive and corrosion resistant coating up to service temperature of about 900 °C.

SK 235-M is used primarily as a hard corrosion resistant interface. We recommend to apply thickness not exceeding 12 mm.

Hardness as deposited: NA

**Typical analysis in %**

C	Mn	Si	Cr	B	Fe
0.06	1.8	1.7	29.0	3.4	balance

**Welding instructions**

Observe normal spraying practices, respiratory protection and proper air flow pattern advised.

For general spray practices, see AWS C2.1-73.

Thermal spraying is a completely safe process when performed in accordance with proper safety measures.

Become familiar with local safety regulations before starting spray operations.

**Form of delivery and recommended welding parameters**

Wire diameter [mm]	Amperage	Voltage [V]	Psi	Spray Dist
1.6	150 – 350	29 – 31	60 – 80	100 – 200

**Characteristics and field of use**

Flux cored wire for the arc spraying process.

Hard coating with good oxydation resistance.

Hardness as deposited: NA

**Typical analysis in %**

C	Mn	Si	Cr	Fe	B
4.5	0.7	1.3	26.0	balance	0.3

**Welding instructions**

Observe normal spraying practices, respiratory protection and proper air flow pattern advised.

For general spray practices, see AWS C2.1-73.

Thermal spraying is a completely safe process when performed in accordance with proper safety measures.

Become familiar with local safety regulations before starting spray operations.

**Form of delivery and recommended welding parameters**

Wire diameter [mm]	Amperage	Voltage [V]	Psi	Spray Dist
1.6	150 – 350	29 – 31	60 – 80	100 – 200

**Characteristics and field of use**

SK 420-M is a chrome steel cored wire made exclusively for arc spraying to ensure a good corrosion and oxidation resistance.

Hard coatings with good oxidation and corrosion resistances.

Hardness as deposited: NA

**Typical analysis in %**

C	Mn	Si	Cr	Fe
0.4	0.5	0.4	14.0	balance

**Welding instructions**

Observe normal spraying practices, respiratory protection and proper air flow pattern advised.

For general spray practices, see AWS C2.1-73.

Thermal spraying is a completely safe process when performed in accordance with proper safety measures.

Become familiar with local safety regulations before starting spray operations.

**Form of delivery and recommended welding parameters**

Wire diameter [mm]	Amperage [A]	Voltage [V]	Psi	Spray Dist
1.6	150 – 350	29 – 31	60 – 80	100 – 125

**Characteristics and field of use**

Arc-spraying cored wire designed to produce a hard abrasive and corrosion resistant coating up service temperature of about 900 °C.

SK 848-M is used primarily as a hard corrosion resistant interface. We recommended to apply thickness not exceeding 12 mm.

Hardness as deposited: NA

**Typical analysis in %**

C	Mn	Si	Cr	Ni	Mo	B	Fe
0.05	2.1	1.8	29	5.5	0.08	3	balance

**Welding instructions**

Observe normal spraying practices, respiratory protection and proper air flow pattern advised.

For general spray practices, see AWS C2.1-73.

Thermal spraying is a completely safe process when performed in accordance with proper safety measures.

Become familiar with local safety regulations before starting spray operations.

**Form of delivery and recommended welding parameters**

Wire diameter [mm]	Amperage	Voltage [V]	Psi	Spray Dist
1.6	150 – 350	29 – 31	60 – 80	100 – 200

## Cored wires

### 2. Nickel alloys

Product name	Alloy type	Low stress abrasion	High stress abrasion	Erosion	Impact	Corrosion	Cavitation	Metal to metal wear	Heat	Page
SK 825-M	Nickel alloys					■			■	478
SK 830-MF	Nickel alloys	■				■			■	479
SK 840-MF	Nickel alloys					■				480
SK 850-MF	Nickel alloys	■				■			■	481
SK 858-M	Nickel alloys					■			■	482
SK 860-MF	Nickel alloys		■			■			■	483
SK 868-M	Nickel alloys					■			■	484
SK 900-MF	Nickel alloys		■			■			■	485

#### Solution examples

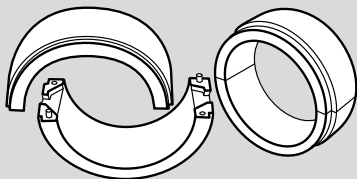

*Bearings journal*

SK 830-MF

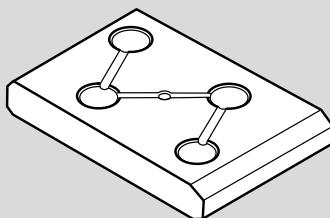

*Wear plate*

SK 900-MF

cored wire for arc spraying

**Characteristics and field of use**

Arc-spraying Ni-base cored wire with addition of Molybdenum and Aluminium designed to produce a high quality, high tensile bondcoat. The alloy gives a tough and dense coating, resistant to high temperature oxidation, thermal shock and abrasion.

Bondcoats and coatings.

Hardness as deposited: NA

**Typical analysis in %**

Ni	Mo	Al
balance	5.0	6.5

**Welding instructions**

Observe normal spraying practices, respiratory protection and proper air flow pattern advised.

For general spray practices, see AWS C2.1-73.

Thermal spraying is a completely safe process when performed in accordance with proper safety measures.

Become familiar with local safety regulations before starting spray operations.

**Form of delivery and recommended welding parameters**

<i>Wire diameter [mm]</i>	<i>Amperage [A]</i>	<i>Voltage [V]</i>	<i>Psi</i>	<i>Spray Dist</i>
1.6	100 – 300	29 – 31	60 – 80	100 – 200



cored wire for arc spraying

**Characteristics and field of use**

SK 830-MF is a cored wire made exclusively for Arc Spraying, especially developed for spraying with subsequent fusion. It is a Ni-base alloy with addition of Boron and Silicon.

Application needing high oxidation, heat and corrosion resistance.

Hardness as deposited: NA

**Typical analysis**

Ni, B, Si

**Welding instructions**

Observe normal spraying practices, respiratory protection and proper air flow pattern advised.

For general spray practices, see AWS C2.1-73.

Thermal spraying is a completely safe process when performed in accordance with proper safety measures.

Become familiar with local safety regulations before starting spray operations.

**Form of delivery and recommended welding parameters**

<i>Wire diameter [mm]</i>	<i>Amperage [A]</i>	<i>Voltage [V]</i>	<i>Psi</i>	<i>Spray Dist</i>
1.6	100 – 300	29 – 31	40 – 60	100 – 200

**Characteristics and field of use**

Cored wire made exclusively for Arc Spraying, especially developed for spraying with subsequent fusion. It is a Ni-base alloy with addition of Boron and Silicon.

Application needing high oxidation, heat and corrosion resistance.

Hardness as deposited: NA

**Typical analysis**

Ni, Cr, B, Si

**Welding instructions**

Observe normal spraying practices, respiratory protection and proper air flow pattern advised. For general spray practices, see AWS C2.1-73. Thermal spraying is a completely safe process when performed in accordance with proper safety measures. Become familiar with local safety regulations before starting spray operations.

**Form of delivery and recommended welding parameters**

<i>Wire diameter [mm]</i>	<i>Amperage [A]</i>	<i>Voltage [V]</i>	<i>Psi</i>	<i>Spray Dist</i>
1.6	100 – 300	29 – 31	40 – 60	100 – 200

cored wire for arc spraying

**Characteristics and field of use**

Cored wire made exclusively for Arc Spraying, especially developed for spraying with subsequent fusion. It is a Ni-base alloy with addition of Boron and Silicon.

Application needing a resistance to abrasive wear combined with corrosion.

Hardness as deposited: NA

**Typical analysis**

Ni, Cr, B, Si

**Welding instructions**

Observe normal spraying practices, respiratory protection and proper air flow pattern advised. For general spray practices, see AWS C2.1-73. Thermal spraying is a completely safe process when performed in accordance with proper safety measures. Become familiar with local safety regulations before starting spray operations.

**Form of delivery and recommended welding parameters**

<i>Wire diameter [mm]</i>	<i>Amperage [A]</i>	<i>Voltage [V]</i>	<i>Psi</i>	<i>Spray Dist</i>
1.6	100 – 300	29 – 31	40 – 60	100 – 200

cored wire for arc spraying

**Characteristics and field of use**

SK 858-M is a unique Nickel and Aluminium wire produced specifically for the production of a high quality, high tensile bondcoat for use exclusively with the arc spray process.

Bondcoat.

Hardness as deposited: NA

**Typical analysis in %**

	Ni	Al
Pure deposited metal	balance	5.0

**Welding instructions**

Observe normal spraying practices, respiratory protection and proper air flow pattern advised. For general spray practices, see AWS C2.1-73. Thermal spraying is a completely safe process when performed in accordance with proper safety measures. Become familiar with local safety regulations before starting spray operations.

**Form of delivery and recommended welding parameters**

Wire diameter [mm]	Amperage [A]	Voltage [V]	Psi	Spray Dist
1.6*	100 – 300	29 – 31	60 – 80	100 – 200

\*available on request

cored wire for arc spraying

**Characteristics and field of use**

SK 860-MF is a cored wire made exclusively for Arc Spraying, especially developed for spraying with subsequent fusion. It is a Ni-base alloy with addition of Boron and Silicon.

Application needing a high resistance to abrasive wear combined with corrosion.

Hardness as deposited: NA

**Typical analysis**

Ni, Cr, B, Si

**Welding instructions**

Observe normal spraying practices, respiratory protection and proper air flow pattern advised. For general spray practices, see AWS C2.1-73. Thermal spraying is a completely safe process when performed in accordance with proper safety measures. Become familiar with local safety regulations before starting spray operations.

**Form of delivery and recommended welding parameters**

<i>Wire diameter [mm]</i>	<i>Amperage [A]</i>	<i>Voltage [V]</i>	<i>Psi</i>	<i>Spray Dist</i>
1.6	100 – 300	29 – 31	40 – 60	100 – 200

\*available on request

cored wire for arc spraying

**Characteristics and field of use**

SK 868-M is a cored wire made exclusively for arc spraying which when applied will provide a coating with an extreme resistance to corrosion caused by gases and ashes containing sulphur and Vanadium compounds resulting from high temperature combustion.

Boiler pipes.

Hardness as deposited: NA

**Typical analysis in %**

Cr	Ni	Ti
45.0	balance	4.0

**Welding instructions**

Observe normal spraying practices, respiratory protection and proper air flow pattern advised. For general spray practices, see AWS C2.1-73. Thermal spraying is a completely safe process when performed in accordance with proper safety measures. Become familiar with local safety regulations before starting spray operations.

**Form of delivery and recommended welding parameters**

Wire diameter [mm]	Amperage [A]	Voltage [V]	Psi	Spray Dist
1.6	100 – 300	29 – 31	60 – 80	100 – 200

\*available on request

cored wire for arc spraying

**Characteristics and field of use**

Arc-spraying Ni-base cored wire with addition of Boron, Silicon and Tungsten carbides (30 %) especially developed for spraying with subsequent fusion.

Suitable for thick-coating on parts subject to both high abrasion and corrosion: feeding screw in the wood industry, hammers, dredging wear parts, etc.

Hardness as deposited: NA

**Typical analysis**

Ni, Cr, B, Si, W

**Welding instructions**

Observe normal spraying practices, respiratory protection and proper air flow pattern advised. For general spray practices, see AWS C2.1-73. Thermal spraying is a completely safe process when performed in accordance with proper safety measures. Become familiar with local safety regulations before starting spray operations.

**Form of delivery and recommended welding parameters**

<i>Wire diameter [mm]</i>	<i>Amperage [A]</i>	<i>Voltage [V]</i>	<i>Psi</i>	<i>Spray Dist</i>
1.6 x 1000	100 – 300	29 – 31	40 – 60	100 – 200

## Description of the plasma transferred arc process

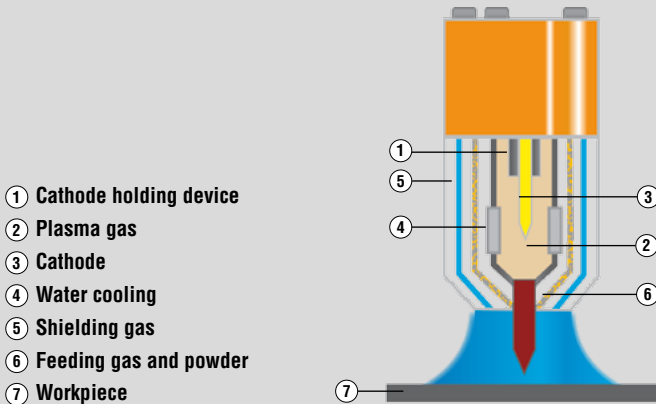

Plasma powder surfacing (PPS), also known as the plasma transferred arc (PTA) process, is a thermal coating process. In contrast to the spraying processes, this method is a welding process and so involves metallurgical bonding of the applied material to the base material. However, if the parameters are set optimally, the degree to which it blends with the base material can be reduced to a minimum. The PTA process is employed primarily for surfacing of wear resistant and corrosion resistant coatings on to a base material.

The process is characterised by the use of two separately controllable electric arcs. One of these is the (non-transferred) pilot arc; this arc is formed between the non-melting (tungsten) electrode and the plasma nozzle. It accelerates the plasma gas and enables ignition of the (transferred) main arc. This arc burns with a high energy density between the electrode and the workpiece. With the aid of the electric arc, both the base material and the metal powder that serves as the welding consumable are fused together, which then gives rise to the deposited protective coating. Ar, H<sub>2</sub>, He, or mixtures of gas are employed as a processing gas. This serves, firstly, as a plasma gas and, secondly, as a shielding gas and as a carrier gas for the powder.

In smaller grain sizes (typical 45 – 125 µm) also suitable for Laser Welding.



## Powders

### 1. PLASweld™ – Powders for hard facing

#### PLASweld™ - Powder description

Alloyed metal powder (some with hard additives)

Round grain, smooth surface, gas atomized (except hard material additives)

Typical particle size: – 150+50 microns or – 200+63 microns

Surface hardening of about 170 HV (buffer layers) up to 60 HRC

Product name	Grain size*	Chem. composition	Hardness
PLASweld™ 73 G2	– 150 + 50 µm	FeCrMo	55 HRC
PLASweld™ 73 G3	– 150 + 50 µm	FeCrMo	45 HRC
PLASweld™ 73 G4	– 150 + 50 µm	FeCrMo	39 HRC
PLASweld™ Celsit 706	– 150 + 50 µm	CoCrWC	41 HRC
PLASweld™ Celsit 706HC	– 150 + 50 µm	CoCrWC	43 HRC
PLASweld™ Celsit 708	– 150 + 50 µm	CoCrNiWC	45 HRC
PLASweld™ Celsit 712	– 150 + 50 µm	CoCrWC	48 HRC
PLASweld™ Celsit 712HC	– 150 + 50 µm	CoCrWC	49 HRC
PLASweld™ Celsit 721	– 150 + 50 µm	CoCrMoNiC	32 HRC
PLASweld™ Celsit 780	– 150 + 50 µm	CoMoCr	55-60 HRC
PLASweld™ Ferro 44	– 125 + 38 µm	FeCrCoMo	44 HRC
PLASweld™ Ferro V1	– 125 + 45 µm	FeCrMoWV	58 HRC
PLASweld™ Ferro V10	– 150 + 50 µm	FeCrV	60 HRC
PLASweld™ Ferro V12	– 150 + 50 µm	FeCrV	61 HRC
PLASweld™ Ferro V15	– 150 + 50 µm	FeCrV	61 HRC
PLASweld™ Ledurit 60	– 150 + 50 µm	FeCrC	57 HRC
PLASweld™ Ledurit 68	– 150 + 50 µm	FeCrCB	62 HRC
PLASweld™ Ledurit 68	– 150 + 50 µm	FeCrCBV	62 HRC
PLASweld™ Nibas 34G	– 200 + 63 µm	NiCrBSiP	34 HRC
PLASweld™ NiBas 068HH	– 150 + 50 µm	NiCrFeNb	170 HB
PLASweld™ NiBas 776	– 150 + 50 µm	NiCrMoW	170 HB
PLASweld™ NiBas 6222Mo	– 150 + 50 µm	NiCrMoNb	200 HB
PLASweld™ NiBas W60	– 150 + 50 µm	NiBSi+WSC	Matrix 60 HRC
PLASweld™ Stainless 18	– 150 + 50 µm	FeCrNiMo	18 HRC
PLASweld™ Stainless 19	– 150 + 50 µm	FeCrMo	19 HRC

\* Also available in grain size –200 + 63 µm or according to customers requirements.

## List of contents

### Special products

<b>Covered electrodes</b>	<b>489</b>
1. Chamfering and gouging covered electrodes	489
2. Underwater repair electrode	489
<b>Gas rods</b>	<b>493</b>
1. Covered electrodes for cutting and gouging	493
<b>Cored Wires</b>	<b>498</b>
1. Cutting cored wire	498

## Covered electrodes

### 1. Chamfering and gouging covered electrodes

Product name	Description	Page
UTP 82 AS	Chamfering stick electrode for metallic materials.	490
UTP 82 Ko	Carbon stick electrode for arc-air gouging of all industrial metals.	491

### 2. Underwater repair electrode

Product name	Description	Page
Phoenix Nautica 20	Covered electrode for manual metal arc welding under hyperbaric wet conditions.	492

## UTP 82 AS

covered electrode

### Characteristics and field of use

The strongly coated chamfering stick electrode UTP 82 AS can be used on all steel grades with ferritic and austenitic structure, as well as cast iron, cast steel and all non-ferrous metals. It enables workpieces to be grooved out in a very simple way. UTP 82 AS is also suitable for removing corroded metal layers and for fusion-cutting metallic materials.

UTP 82 AS strikes easily and generates a high gas pressure, enabling a clean and smooth cut to be achieved.

### Welding instructions

When grooving it is advisable to tilt the plate in the direction of working, so that the molten parent metal can run off better. The stick electrode should be inclined to the parent metal as horizontally as possible (approx. 15 °) and kept constantly in contact with it. The working speed is increased by slight pushing movements in the direction of working. Parent metal left on the edge of the groove is easily removed with the slag hammer. Machining the groove down to the bare metal may be advisable, depending on the circumstances.

### Current type

DC (–) / AC

### Form of delivery and recommended welding parameters

<i>Electrodes Ø mm x L</i>	2.5 x 250	3.2 x 350	4.0 x 350	5.0 x 350
<i>Amperage</i>	150 – 250	200 – 300	250 – 400	350 – 500

## UTP 82 Ko

covered electrode

### Characteristics and field of use

UTP 82 Ko is suited for pointing and cutting of all metals melting in the arc, such as all steels and cast steels, cast iron materials, aluminium-, nickel- and copper alloys.

High pointing rate, universally applicable, high economic efficiency.

### Welding instructions

High tensile steels susceptible to a hardness increase should be preheated to 150 – 400 °C, just as copper.

Compressed air approx. 4.5 bar

### Current type

DC (+)

### Form of delivery and recommended welding parameters

<i>Electrodes Ø mm x L</i>	4.0 x 305	8.0 x 305*	9.5 x 305*
<i>Amperage</i>	180 – 220	350 – 500	500 – 650

\*available on request

# Phoenix Nautica 20

## Classifications

underwater electrode

DIN 2302

E 42 0 Z RR 2 UW 10 fr

## Characteristics and field of use

Covered electrode for manual metal arc welding under hyperbaric wet conditions down to 20 msw. Very good weldability in vertical down position.

## Base materials

S235JRG2 – unalloyed and fine grained structural steels. Higher strength structural steels should not be welded with this type of electrodes as these materials are susceptible to “Hydrogen Induced Cold Cracking (HICC)” when welded in wet environment. The carbon content of the parent metal should not exceed 0.15 %.

## Typical analysis in %

C	Si	Mn	Mo
0.08	0.30	0.55	0.50

## Mechanical properties of the weld metal

Heat treatment	0.2%-Yield strength	Tensile strength	Impact values CVN
	MPa	MPa	J
AW	420	500	38

## Welding positions

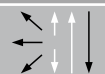

Current type DC (+) / DC (-)

## Approvals

GL

## Form of delivery and recommended welding parameters

Electrodes $\varnothing$ mm x L	Amperage [A]
3.2 x 350	150 – 200

### 1. Covered electrodes for cutting and gouging

Product name	Description	Page
UTP 5 / Flux 5	Welding rod for oxy-acetylene hot welding of cast iron qualities	494
UTP 7502	Gas welding cast rod with low melting matrix and coarse hard metal grain for deep drilling technique.	495
UTP A 7550	Heavy coated, flexible tungsten-carbide welding rod against extreme mineral friction wear, corrosion resistant.	496
UTP A 7560	Tungsten-carbide tube rod against extreme mineral abrasion.	497

**UTP 5 / Flux 5****Classifications** Welding rod for oxy-acetylene hot welding of cast iron qualities

EN ISO 1071

AWS A5.15

R C Z FeC-1

R-CI mod.

**Characteristics and field of use**

UTP 5 is used for oxy-acetylene hot welding of cast iron qualities, when a weld deposit of the same color and similar properties is required, e.g. for production welding of new parts (engine blocks, pump housings, etc.) or repair welding of stress-susceptible cast iron parts. The weld deposit is machinable with cutting tools.

Properties of the weld metal

The weld deposit of UTP 5 shows the same visual appearance and similar properties to grey cast iron (GJL).

Hardness of the pure weld metal  
approx. 200 HB

**Typical analysis in %**

C	Si	Mn	Fe
3.2	3.5	0.6	balance

**Welding instructions**

Machine the weld area to a bright metallic finish, bevel the edges and preheat the casting part homogeneously up to 500 – 600 °C. Slightly preheat the rod, then dip the tip of the warm welding rod into UTP Flux 5 to allow proper adhesion of the flux to the rod. Repeat this step throughout the entire process. Use neutral flame setting and apply the flame in a gentle circular movement to the welding pool to keep it in a pasty-iron state. Allow for a slow cool-down, e.g. in a furnace or covered by sand or any other thermally insulating material.

Flame setting

In general neutral, on a case-by-case basis also oxygen- or acetylene excess in order to avoid porosity.

**Blank cast rods [Ø mm x L]****UTP Flux 5**

6.0 x 500

0.5 kg

8.0 x 500

0.5 kg

10.0 x 500

0.5 kg



## UTP 7502

### Classifications

gas rod

Special alloy

### Characteristics and field of use

UTP 7502 is suitable for high wear resistant cladding in the deep drilling technique, e.g. drill bits for core removing holes, stabilizer, face cutters such as in mining and foundries. The oxy-acetylene rod is made of a special CuZnNi-matrix with inlayed tungsten-carbides. Their regular distribution enables high quality claddings.

The weld deposit of UTP 7502 consists of very hard tungsten carbides, imbedded in a corrosion resistant matrix.

Hardness

Carbide approx. 2500 HV

Working temperature approx. 900 °C

### Typical analysis in %

W <sub>2</sub> C	CuZnNi-Matrix
60.0	40.0

### Welding instructions

The cladding surface has to be cleaned to metallic bright and has to be free of impurities. Spread flux UTP Flux HLS-B on the surface, apply a thin layer of the brazing alloy UTP 2. The use of this flux is also recommended when applying UTP 7502. Avoid overheating.

Flame adjustment: neutral (neither gas – nor oxygen-excess)

### Form of delivery

Length of rod [mm]	Weights of rod (g)	Grain size [mm]
approx. 450	approx. 500	1.6 – 3.2*
approx. 450	approx. 500	3.2 – 4.8*

\*available on request

## UTP A 7550

### Classifications

gas rod

DIN 8555

EN 14700

G/WSG 21-UM-55-CG

C Ni 20

### Characteristics and field of use

UTP A 7550 can be welded by oxy-acetylene or TIG process. The rod is based on a NiCrBSi matrix containing tungsten carbides. These carbides have two different grain sizes and build a compact wear-resistant deposit. The matrix melts at 1050 °C, i.e. below the melting range of steels.

UTP A 7550 is particularly suitable for claddings on machine parts subject to extreme friction wear by hard, abrasive materials. This alloy is used in brickyards, the clay industry, cement factories, mining and offshore as well as for the production of equipment and machines for the above-mentioned industries.

Only suitable for slight to medium impact stress. The weld deposit is corrosion-resistant.

Hardness:

Carbides: approx. 2500 HV

Matrix: approx. 55 HRC

### Typical analysis in %

W<sub>2</sub>C

NiCrBSi-Matrix

60.0

40.0

### Welding instructions

The weld area must be metallic clean. Preheating to 300 – 500 °C depending on the size of the workpiece. Keep welding torch flat to the work piece and slightly melt the surface. Avoid overheating.

### Form of delivery and recommended welding parameters

<i>Rod diameter x length [mm]</i>	<i>Current type</i>	<i>Shielding gas</i>
Ø 6.0 x 450 mm length	DC (-)	I 1
Ø 5.0 mm spooled wire	DC (-)	I 1
Ø 6.0 mm spooled wire	DC (-)	I 1

# UTP A 7560

## Classifications

gas rod

DIN 8555

EN 14700

G 21-GF-60 G

T Fe 20

## Characteristics and field of use

The filled gas welding rod UTP A 7560 is suitable for claddings on tools and machine parts subject to highest mineral wear, such as drill bits, roller bits, sets of drill-rods, excavator buckets, mixer blades. It is also suitable for highly stressed machine parts, which are used for the reprocessing of sand, cement, lime, clay, coal, slags.

UTP A 7560 is suited for extreme mineralic abrasion with medium impact strain.

Hardness

Carbide: approx. 2500 HV

Matrix: approx. 60 HRC

## Typical analysis in %

W<sub>2</sub>C

FeC

60.0

40.0

## Welding instructions

Clean welding area to metallic bright. Preheating temperature 300 – 500 °C, depending on the size of the workpiece. Hold torch as flat as possible to the workpiece. Melt surface slightly. Avoid overheating.

## Form of delivery and recommended welding parameters

<i>Rod diameter x length [mm]</i>	<i>Current type</i>	<i>Shielding gas</i>
3.5 x 700*	DC (-)	I 1
4.0 x 700*	DC (-)	I 1
5.0 x 700*	DC (-)	I 1

\*available on request

## Cored Wires

### 1. Cutting cored wire

Product name	Description	Page
SK CUTARC	Special flux-cored wire specially developed for gouging applications.	498

## SK CUTARC

cored wire

### Characteristics and field of use

Special cored wire developed for gouging applications in vertical down position. High penetration. Can also be used for cutting applications.

Gouging of old overlays on rolls before re-hardfacing, cutting of steel scrap parts.

Hardness as welded: NA

Gouging rate at 350 A / 40 V	6 – 7 (kg / h)
Gouging rate at 450 A / 40 V	10 – 11 (kg / h)
Gouging rate at 400 A / 35 V	7 – 8 (kg / h)
Gouging rate at 400 A / 40 V	8 – 9 (kg / h)

### Form of delivery and recommended welding parameters

Wire diameter [mm]	Amperage [A]	Voltage [V]	Stick-out [mm]
2.4	400 – 600	32 – 45	35 – 40



# List of contents

## Appendix

<b>Packaging information</b>	<b>501</b>
1. SMAW – covered electrodes	501
2. GTAW – TIG rods	502
3. GMAW – MIG wires	503
4. GMAW – flux cored wires	504
5. SAW – flux and wires	505
6. SAW – strips	508
<b>Diagrams</b>	<b>509</b>
1. Rocha intergranular corrosion diagram	509
2. Schaeffler diagram	509
3. DeLong diagram	510
4. WRC 92 diagram	510
<b>Guidelines for the storage and transport of cored welding wires for general applications</b>	<b>511</b>
<b>Guidelines for the storage and transport of solid welding wire and rods for general applications</b>	<b>512</b>
<b>Guidelines for the storage and rebaking of welding consumables for nuclear power plants and general applications</b>	<b>513</b>
<b>Material test certificates according to EN 10 204</b>	<b>516</b>
<b>Hardness conversion table</b>	<b>517</b>
<b>Metallography structures</b>	<b>519</b>
1. Austenitic	519
2. Martensitic	519
3. Complex carbide microstructure with austenitic or martensitic iron matrix	520
<b>Welding positions according to EN ISO 6947 und ASME code, section IX</b>	<b>521</b>
<b>Alphabetical product index</b>	<b>523</b>

## Packaging information

### 1. SMAW – covered electrodes

#### Boxes for stick electrodes

Length	Quantity	Dimension LxHxW [mm]	Material
250 mm	1 Box	255 x 75 x 57	Folded carton in shrink foil
	4 Boxes	260 x 80 x 246	Corrugated cardboard
300 mm	1 Box	305 x 75 x 57	Folded carton in shrink foil
	4 Boxes	310 x 80 x 246	Corrugated cardboard
350 mm	1 Box	355 x 75 x 57	Folded carton in shrink foil
	4 Boxes	360 x 80 x 246	Corrugated cardboard
450 mm	1 Box	455 x 75 x 57	Folded carton in shrink foil
	4 Boxes	460 x 80 x 246	Corrugated cardboard



#### Cans for stick electrodes

Length	Quantity	Dimension LxHxW [mm]	Material
250/350 mm	1 Can	Ø 75 x 362	Tinplate can, painted
	3 Cans	88 x 240 x 375	Corrugated cardboard
450 mm	1 Can	Ø 75 x 462	Tinplate can, painted
	3 Cans	88 x 240 x 475	Corrugated cardboard



Number and weight units of stick electrodes depends on each type of electrodes and can not be advised yet. Please ask for further information.

## Packaging information

### 1. SMAW – covered electrodes

#### Vakuum packing "ExtraDry"

Length	Quantity	Dimension LxHxW [mm]	Material
350 mm	1 Bowl	365 x 27 x 75	Plastic bowl, wrapped in aluminum laminated foil
	9 Bowls	390 x 105 x 255	Corrugated cardboard
450 mm	1 Bowl	465 x 27 x 75	Plastic bowl, wrapped in aluminum laminated foil
	9 Bowls	490 x 105 x 255	Corrugated cardboard



## Packaging information

### 2. GTAW – TIG rods

#### Cardboard tube packing

Length	Weight	Quantity	Dimension LxHxW [mm]	Material
1000 mm	5 kg	1 Tube	L 1015 x Ø 45	Cardboard tube with integrated VCI foil
	20 kg	4 Tubes	1025 x 54 x 190	Corrugated cardboard





# Packaging information

## 3. GMAW – MIG wires

### Spools according to EN ISO 544

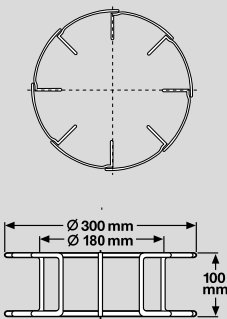
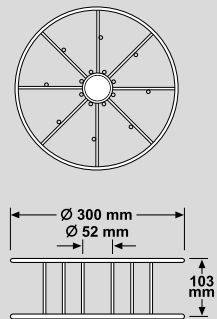
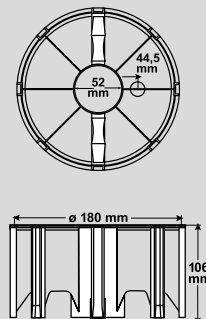
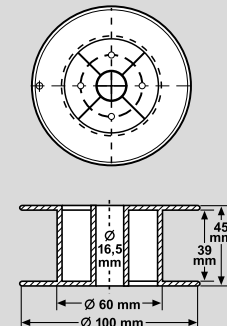
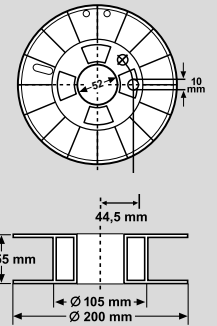
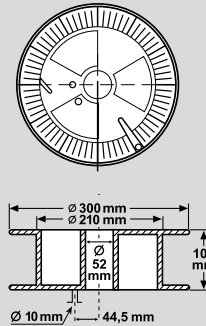
																		
<p><b>B 300</b></p> <table border="1"> <tr> <td>Wire weight: [kg]</td> <td>12.5/15/18</td> </tr> <tr> <td>Material:</td> <td>Steel wire, coppered</td> </tr> <tr> <td>Use:</td> <td>Disposable</td> </tr> </table>	Wire weight: [kg]	12.5/15/18	Material:	Steel wire, coppered	Use:	Disposable	<p><b>BS 300</b></p> <table border="1"> <tr> <td>Wire weight: [kg]</td> <td>12.5/15/18</td> </tr> <tr> <td>Material:</td> <td>Steel wire, coated</td> </tr> <tr> <td>Use:</td> <td>Disposable</td> </tr> </table>	Wire weight: [kg]	12.5/15/18	Material:	Steel wire, coated	Use:	Disposable	<p><b>Adapter for B 300</b></p> <table border="1"> <tr> <td>Material:</td> <td>Plastic</td> </tr> <tr> <td>Use:</td> <td>Returnable</td> </tr> </table>	Material:	Plastic	Use:	Returnable
Wire weight: [kg]	12.5/15/18																	
Material:	Steel wire, coppered																	
Use:	Disposable																	
Wire weight: [kg]	12.5/15/18																	
Material:	Steel wire, coated																	
Use:	Disposable																	
Material:	Plastic																	
Use:	Returnable																	
																		
<p><b>B 300</b></p> <table border="1"> <tr> <td>Wire weight: [kg]</td> <td>12.5/15/18</td> </tr> <tr> <td>Material:</td> <td>Steel wire, coppered</td> </tr> <tr> <td>Use:</td> <td>Disposable</td> </tr> </table>	Wire weight: [kg]	12.5/15/18	Material:	Steel wire, coppered	Use:	Disposable	<p><b>BS 300</b></p> <table border="1"> <tr> <td>Wire weight: [kg]</td> <td>12.5/15/18</td> </tr> <tr> <td>Material:</td> <td>Steel wire, coated</td> </tr> <tr> <td>Use:</td> <td>Disposable</td> </tr> </table>	Wire weight: [kg]	12.5/15/18	Material:	Steel wire, coated	Use:	Disposable	<p><b>Adapter for B 300</b></p> <table border="1"> <tr> <td>Material:</td> <td>Plastic</td> </tr> <tr> <td>Use:</td> <td>Returnable</td> </tr> </table>	Material:	Plastic	Use:	Returnable
Wire weight: [kg]	12.5/15/18																	
Material:	Steel wire, coppered																	
Use:	Disposable																	
Wire weight: [kg]	12.5/15/18																	
Material:	Steel wire, coated																	
Use:	Disposable																	
Material:	Plastic																	
Use:	Returnable																	

## Packaging information

### 4. GMAW – flux cored wires

#### Spools according to EN ISO 544

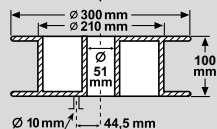
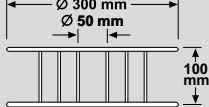
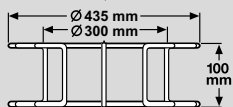
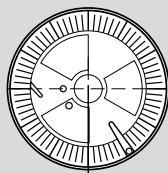
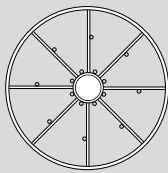
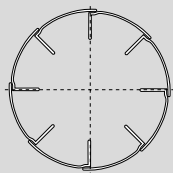

#### K 435 (B 450)

Wire weight: 25 [kg]

Material: Steel wire, copperd

Use: Disposable

#### B 300

Wire weight: 15 [kg]

Material: Steel wire, coated

Use: Disposable

#### S 300

Wire weight: 10 [kg]

Material: Plastic

Use: Returnable

#### Autopack

Weight [kg]:	150	250
Dimension [mm]:	Ø 585 x 470	Ø 560 x 845



## Packaging information

### 5. SAW – flux and wires

#### One way spools

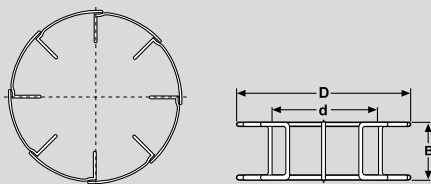

Spool designation	Type EN ISO 544	Dimension D / d / B [mm]	Weight [kg]	Material	for wire diameter [mm]
<b>K 415-100</b>	Basket ring spool B 450	415 / 300 / 103	25	steel wire	2.0 – 4.0
<b>K 300</b>	Basket ring spool B 300	300 / 180 / 103	15 / 18	steel wire	1.2 – 2.0

#### Drum packings

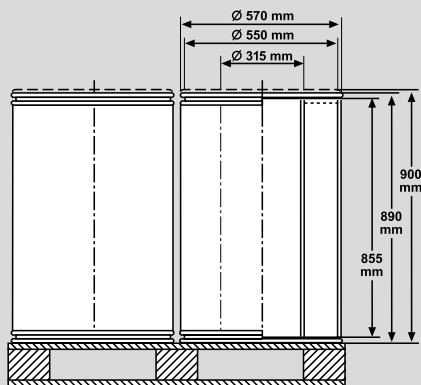

Wire electrode:	Ø 2.0 – 5.0 mm
Wire weight:	150 / 250 / 350 kg
Pallets:	2 Drums / Euro pallet (1200 x 800 mm)
Material:	Fiber drum (Cardboard) with metal ring
Use:	One way

## Packaging information

### 5. SAW – flux and wires

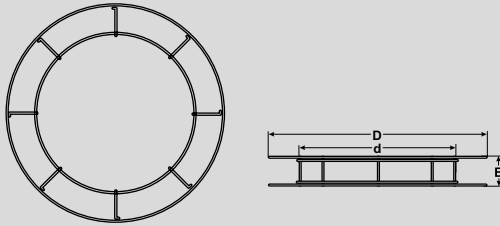

#### Returnable spool

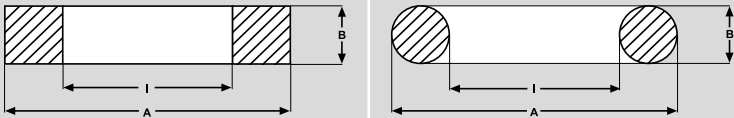

Spool designation	Type EN ISO 544	Dimension D / d / B [mm]	Weight [kg]	Material
<b>K 800</b>	–	825 / 600 / 115	100	steel wire

#### Coil dimensions



Coil designation		Dimension D / d / B [mm]	Weight [kg]
	<b>AA*</b>	770 / 570 / 100	100
	<b>C</b>	320 / 220 / 50	10

\*on request

## Packaging information

### 5. SAW – flux and wires

#### Bag and drums

Weight [kg]:	25 kg	250
--------------	-------	-----



#### Large packing: Big Bag

Weight:	500 / 1000 kg
Dimension:	Gaps between hanging up latches: approx. 800 x 800 mm  Dimension of Big Bag on pallet:  500 kg: 1000 x 1000 x 550 mm  1000 kg: 1000 x 1000 x 1050 mm  Dimensions are reference values, because of more or less bulge of Big Bags.



## Packaging information

### 5. SAW – flux and wires

#### Heavy duty steel dispenser, large

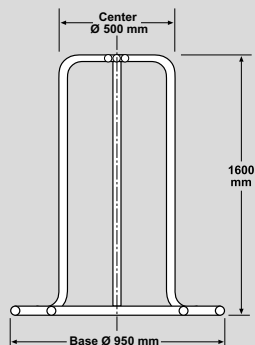
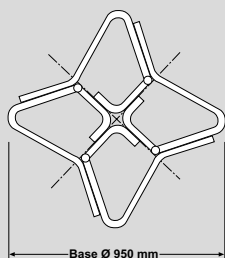

*Weight:* ca. 750 kg

*Material:* Steel sheet



## Packaging information

### 6. SAW – strips



*Width & Thickness*

*Width & Coil*

15 x 0.5 mm 15 – 20 kg

20 x 0.5 mm 20 – 25 kg

30 x 0.5 mm 25 – 30 kg

60 x 0.5 mm 55 – 60 kg

90 x 0.5 mm 75 – 90 kg

# Diagrams

## 1. Rocha intergranular corrosion diagram

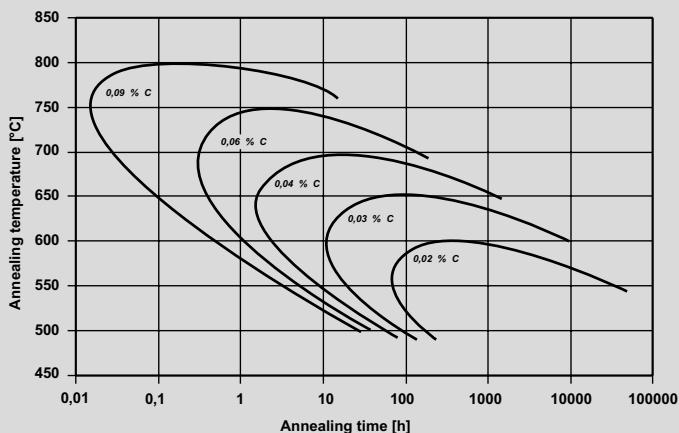

Range of intergranular corrosion for 18/8 chromium-nickel steels in relation to the free carbon content (acc. to H.J. Rocha)

## 2. Schaeffler diagram

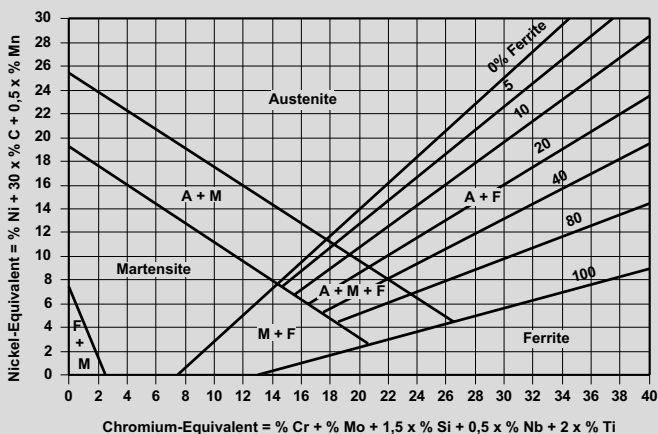

Schaeffler - Diagram

(acc. to A. L. Schaeffler, Metal Progress Nov. 1949, page 680 up to 680-B)

# Diagrams

## 3. DeLong diagram

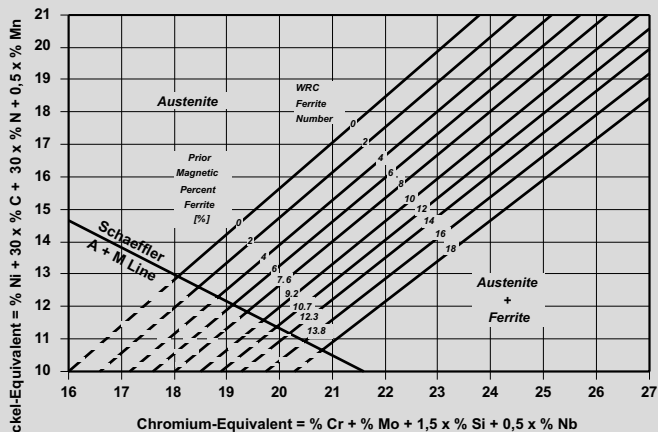

DeLong - Diagram

(acc. to W. T. DeLong, Welding Journal, July 1974, page 273-s up to 286-s)

## 4. WRC 92 diagram

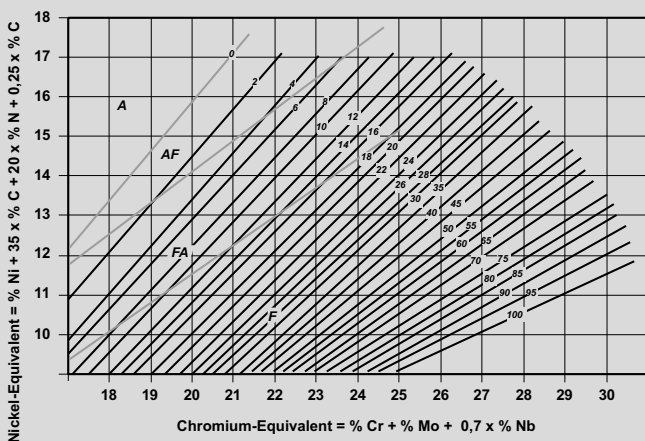

WRC - 92 - Diagram

(acc. to D. J. Kotecki und T. A. Siewert, Welding Journal; May 1992, page 171-s up to 178-s)



# Guidelines for the storage and transport of cored welding wires for general applications

## 1. General conditions

- 1.1 These guidelines are valid for general application for storage and transport of cored welding wire. This does not however release the user from his duty and responsibility in convincing himself of the faultless condition of the welding consumables in question.

## 2. Storage and Transport

- 2.1 Whenever welding consumables are transported, care must be taken that the material itself or the packaging is not damaged. The stacked height of cartons and packages should not exceed 6 units.

Precautions should be taken that older deliveries are used before newer ones (first in, first out).

Precautions should be taken to avoid storage in damp areas while in original packaging condition. To protect welding consumables against moisture pick up during long term storage, store preferably in a room with max. 60% relative atmospheric humidity and a temperature of 18 – 23 °C. Temperature fluctuations should be avoided in order to prevent condensation.

Storage in direct contact with the floor or walls should be avoided.

- 2.2 Seamed and seamless cored wires in undamaged packages can be stored under mentioned conditions for a term of two years without reapplied usability testing. Start of storage term is the date when the purchaser's reception control certifies the correct status of the delivery directly after its incoming.
- 2.3 Improper storage and handling of cored wire can cause visible damage to the welding consumables. They may show defects such as kinks, bends and rust.

## 3. Redrying of flux cored wires

Even though the storage conditions as in section 2 are maintained it is probably necessary to redry seamed cored wires before they are welded because of safety cases.

Therefore the cored wires have to be unpacked and placed in the drying oven. A redrying temperature of 150 °C is recommended and should be maintained for a duration of 3 hours. In general the redrying procedure is limited to 24 hours.

Seamless cored wires do not require a redrying process.

Attention: Cored wires delivered on plastic spools can not be redried!

# Guidelines for the storage and transport of solid welding wire and rods for general applications

## 1. General conditions

- 1.1 These guidelines are valid for general application for the storage and transport of solid welding wires and rods for arc welding. This does not however release the user from his duty and responsibility in convincing himself of the faultless condition of the welding consumables in question.

## 2. Storage and Transport

- 2.1 Whenever welding consumables are transported, care must be taken that the material itself or the packaging is not damaged. The stacked height of the cartons and packages or sacks should not exceed 6 units.

Precautions shall be taken that older deliveries are used before newer ones (first in, first out).

Precautions should be taken to avoid storage in damp areas while in original packaging condition. To protect welding consumables against moisture pick up during long term storage, store preferably in a room with a maximum of 60 % relative atmospheric humidity and a temperature of 18 – 23 °C. Temperature fluctuations shall be avoided in order to prevent condensation.

Storage in direct contact with the floor or walls shall be avoided.

- 2.2 All welding consumables that have been removed from their original packaging and not used for an extended period of time shall be stored in a clean and dry room, which is free of dust and sufficiently ventilated. Welding consumables showing evidence of deterioration following extended periods of exposure shall not be used.
- 2.3 Improper storage and handling of solid welding wire and rods can cause visible damage to the welding consumables. They may show defects such as kinks, bends and rust.

## 3. Guarantee

Provided that the guarantee conditions have not been otherwise agreed upon in individual contracts, a guarantee period of 12 months is guaranteed. Substitution claims will be regulated according to our general conditions of delivery and payment, in the event that claims, regardless of type, should be derived from the above recommendations.

# Guidelines for the storage and rebaking of welding consumables for nuclear power plants and general applications

## 1. General conditions

- 1.1 These guidelines are valid for the storage and rebaking of all kinds of welding consumables which are determined for the application in the nuclear sector. This does not however release the user from his duty and responsibility in convincing himself of the faultless condition of the welding consumables in question.
- 1.2 We also recommend the use of these guidelines for all consumables determined for general application.

## 2. Storage

- 2.1 Whenever welding consumables are transported, extreme care must be taken that the material itself or the packaging is not damaged. The stacked height of the cartons and packages or sacks should not exceed 6 units.

Precautions should be taken that older production lots are used before newer ones.

- 2.2 All filler metals have to be stored in a clean and dry room which is free of dust and sufficiently ventilated. To protect the electrodes/fluxes against moisture pick up during storage, they should be stored preferably in a room with max. 60 % relative atmospheric humidity and a temperature of 18 – 23 °C. Temperature fluctuations have to be avoided in order to prevent condensation.

Improper storage and handling of bare solid welding wire and rods can cause visible damage to the filler metals. They may show defects such as links, bends and rust.

The storage in direct contact with the floor or walls should be avoided.

- 2.3 Under the above mentioned conditions and in undamaged packaging, coated electrodes and fluxes can be stored for a maximum of 2 years, without further testing (KTA 1408.3) before usage. The storage period begins at the point when the customer acknowledges the proper conditions of the merchandise, immediately on receipt of the delivery.

## 3. Rebaking of coated electrodes and flux

- 3.1 Even when the storage conditions mentioned in paragraph 2 have been observed, it is advisable, as a safeguard, to rebake the electrodes/fluxes before welding. Before starting the rebaking process, the electrodes should be removed from the packages with the appropriate care and laid in the baking oven. Under no circumstances the stacked height of the electrodes/fluxes in the oven should exceed 40 – 50 mm.

For rebaking, the filler metals should be held at the rebaking temperature of at least 2 hours.

The electrodes can be rebaked several times, although the total rebaking time must not exceed 10 hours.

## Guidelines for the storage and rebaking of welding consumables for nuclear power plants and general applications

### Recommendation for the redrying of electrodes and fluxes

Coated electrodes Application	Type of coating acc. EN ...	Redrying	Redrying temperature [°C]	max. time for total redrying [h]
Mild steel and low- alloyed qualities	A, AR, C, RC, R, RR, RB	No	–	–
	B	Yes	250 – 350	10
Fine grained structural steel qualities with YS ≥ 350/mm <sup>2</sup>	B	Yes	300 – 350	10
Creep- and high temperature resistant qualities	R	No	–	–
	RB	Yes	180 – 200	10
	B	Yes	300 – 350	10
Stainless steels and ni-base qualities	R, B	Yes	250 – 300	10
Duplex-qualities	B, R	Yes	250 – 300	10
(soft) Martensitic and heat resistant ferritic qualities	B, R	Yes	300 – 350	10

If the H<sub>2</sub>-content in the weld deposit is limited to max. 5 ml/100 g, redrying is necessary at 300 up to 350 °C/2 h.

Fluxes	Type of flux acc. EN ...	Redrying	Redrying temperature [°C]	max. time for total redrying [h]
All fluxes; UV ... and UA ...	AR, AB, FB	Yes	300 – 350	10
Marathon 104, 431, 444	FB	Yes	300 – 350	10
Marathon 213	CS	Yes	250 – 300	10

Flux out of sealed drums must not be redried.

#### 4. Intermediate storage of coated electrodes

- 4.1 Intermediate storage in the warming cupboard at:  
120 – 180 °C, for a maximum of 3 weeks.
- 4.2 Intermediate storage in the holding carrier at:  
100 °C – 150 °C, for a maximum of 8 hours.
- 4.3 Intermediate storage of fluxes

Rebaked fluxes which are not bound for direct use, can be stored at a storing temperature of about 150 °C at ± 20 °C for max. 2 weeks. Alternatively this flux can also be stored in sealed steel barrels.

# Guidelines for the storage and rebaking of welding consumables for nuclear power plants and general applications

## 5. Cellulose-electrodes

Cellulosic coated electrodes are produced with a well defined moisture content in the coating. These electrodes are packed in tin cans. Cellulosic electrodes may never be redried.

## 6. Vacuum-package “Extra-Dry”

On special customer's desire electrodes can be packed in a vacuum package. These electrodes can be used without rebaking in a period up to 9 hours after opening the undamaged package. Thereby you will achieve H<sub>2</sub>-contents less than 5 ml/100 g weld deposit.

Electrodes which are not used out of the vacuum package (within 9 hours) can be regenerated by rebaking at 300 – 350 °C for 2 h.

## 7. Return of the electrodes from the working area

After bringing back the coated electrodes/fluxes from the working area, rebaking as mentioned in paragraph 3 is always necessary.

The return of open packages to stock is not permissible.

## 8. Guarantee

Provided that the guarantee conditions have not been otherwise agreed upon in individual contracts, a guarantee period of 12 months is guaranteed. Substitution claims will be regulated according to our general conditions of delivery and payment, in the event that claims, regardless of type, should be derived from the above recommendations.

## Material test certificates according to EN 10 204

Increasingly, certificates attesting the characteristics and property values of the welding filler metals are required by customers or inspection authorities within the framework of the acceptance testing of weldments.

A few explanatory notes are given below with the request that they be kept in mind when making inquiries or ordering.

The EN standard 10 204 is taken as a basis to determine the schedule of such certificates in the case of inquiries and orders. EN 10 204 defines who is responsible for testing and authorized to sign, and whether the certificates must contain details concerning general typical values or specific test results relating to the particular delivery in question.

**We would like to emphasize strongly that the EN standard 10 204 does not contain the following details and that these must be specified by the customer when ordering:**

Scope of testing:	e.g. type and number of tests, individual elements in case of chemical analyses
Consumables:	e.g. type of shielding gas, etc.
Test parameters:	e.g. postweld heat treatment of the test piece, test temperature
Requirements:	e.g. minimum values for yield strength, tensile strength, elongation, impact values, chemical composition tolerances
Inspection society:	e.g. TÜV, Germanischer Lloyd, DB

**3.1 and 3.2 certificates according EN 10 204 are fee-based.**

### Standard certificates issued for filler metals (in excerpts)

Type of certificate	Confirmation of certificate by	Content of the certificate
Test report 2.2	Manufacturer	Non specific values, based on continuous production records
Inspection certificate 3.1	The manufacturer's authorized representative independent of the manufacturing department	Specific test results determined from the consignment or representative lot of this consignment
Inspection certificate 3.2	The manufacturer's authorized representative independent of the manufacturing department and the purchaser's authorized representative or inspector designated by the official regulations.	Specific test results determined from the consignment or representative lot of this consignment

## Hardness conversion table

**R<sub>m</sub>** = Tensile strength (MPa)

**HV** = Vickers hardness

**HB** = Brinell hardness

**HRC** = Rockwell hardness

R <sub>m</sub>	HV	HB	HRC	R <sub>m</sub>	HV	HB	HRC	R <sub>m</sub>	HV	HB	HRC
200	63	60	–	545	170	162	–	890	278	264	
210	65	62	–	550	172	163	–	900	280	266	27
220	69	66	–	560	175	166	–	910	283	269	
225	70	67	–	570	178	169	–	915	285	271	
230	72	68	–	575	180	171	–	920	287	273	28
240	75	71	–	580	181	172	–	930	290	276	
250	79	75	–	590	184	175	–	940	293	278	29
255	80	76	–	595	185	176	–	950	295	280	
260	82	78	–	600	187	178	–	960	299	284	
270	85	81	–	610	190	181	–	965	300	285	
280	88	84	–	620	193	184	–	970	302	287	30
285	90	86	–	625	195	185	–	980	305	290	
290	91	87	–	630	197	187	–	990	308	293	
300	94	89	–	640	200	190	–	995	310	295	31
305	95	90	–	650	203	193	–	1000	311	296	
310	97	92	–	660	205	195	–	1010	314	299	
320	100	95	–	670	208	198	–	1020	317	301	32
330	103	98	–	675	210	199	–	1030	320	304	
335	105	100	–	680	212	201	–	1040	323	307	
340	107	102	–	690	215	204	–	1050	327	311	33
350	110	105	–	700	219	208	–	1060	330	314	
360	113	107	–	705	220	209	–	1070	333	316	
370	115	109	–	710	222	211	–	1080	336	319	34
380	119	113	–	720	225	214	–	1090	339	322	
385	120	114	–	730	228	216	–	1095	340	323	
390	122	116	–	740	230	219	–	1100	342	325	
400	125	119	–	750	233	221	–	1110	345	328	35
410	128	122	–	755	235	223	–	1120	349	332	
415	130	124	–	760	237	225	–	1125	350	333	
420	132	125	–	770	240	228	–	1130	352	334	
430	135	128	–	780	243	231	21	1140	355	337	36
440	138	131	–	785	245	233		1150	358	340	
450	140	133	–	790	247	235		1155	360	342	
460	143	136	–	800	250	238	22	1160	361	343	
465	145	138	–	810	253	240		1170	364	346	37
470	147	140	–	820	255	242	23	1180	367	349	
480	150	143	–	830	258	245		1190	370	352	
490	153	145	–	835	260	247	24	1200	373	354	38
495	155	147	–	840	262	249		1210	376	357	
500	157	149	–	850	265	252		1220	380	361	

R <sub>m</sub>	HV	HB	HRC	R <sub>m</sub>	HV	HB	HRC	R <sub>m</sub>	HV	HB	HRC
510	160	152	–	860	268	255	25	1230	382	363	39
520	163	155	–	865	270	257		1240	385	366	
530	165	157	–	870	272	258	26	1250	388	369	
540	168	160	–	880	275	261		1255	390	371	
1260	392	372	40	1620	497		49	1980	596		55
1270	394	374		1630	500			1990	599		
1280	397	377		1640	503			1995	600		
1290	400	380		1650	506			2000	602		
1300	403	383	41	1660	509			2010	605		
1310	407	387		1665	510			2020	607		
1320	410	390		1670	511			2030	610		
1330	413	393	42	1680	514		50	2040	613		
1340	417	396		1690	517			2050	615		56
1350	420	399		1700	520			2060	618		
1360	423	402	43	1710	522			2070	620		
1370	426	405		1720	525			2080	623		
1380	430	409		1730	527		51	2090	626		
1390	431	410		1740	530			2100	629		
1400	434	413	44	1750	533			2105	630		
1410	437	415		1760	536			2110	631		
1420	440	418		1770	539			2120	634		
1430	443	421	45	1775	540			2130	636		
1440	446	424		1780	541			2140	639		57
1450	449	427		1790	544		52	2145	640		
1455	450	428		1800	547			2150	641		
1460	452	429		1810	550			2160	644		
1470	455	432		1820	553			2170	647		
1480	458	435	46	1830	556			2180	650		
1485	460	437		1840	559			2190	653		
1490	461	438		1845	560		53	2200	655		58
1500	464	441		1850	561				675		59
1510	467	444		1860	564				698		60
1520	470	447		1870	567				720		61
1530	473	449	47	1880	570				745		62
1540	476	452		1890	572				773		63
1550	479	455		1900	575				800		64
1555	480	456		1910	578		54		829		65
1560	481			1920	580				864		66
1570	484		48	1930	583				900		67
1580	486			1940	586				940		68
1590	489			1950	589						
1595	490			1955	590						
1600	491			1960	591						
1610	494			1970	594						

Caution: Because of their approximate nature, conversion tables must be regarded as only an estimate of comparative values. It is recommended that hardness conversions be applied primarily to values such as specification limits, which are established by agreement or mandate, and that the conversion of test data be avoided whenever possible.



## Metallography structures

### 1. Austenitic

#### Field of use & properties comments

An alloy that after solidification and cooling down to room temperature according to such microstructure is generally qualified as an austenitic one. Alloying elements stabilizing the austenite structure are most of the time Carbon, Manganese and Nickel but Chromium and Niobium might be used in combination in order to modify work hardenability and/or abrasion resistance. Austenitic alloys appreciated for building-up tasks, buffering prior overlaying with carbide containing alloys. Austenitic alloys with up to 0.7 % C and 20 – 30 (Mn + Cr) % with or without Ni, providing very stable austenite are appreciated for overlay on carbon and low alloyed steels no matter the dilution could be as well for joints on “hard to weld” steels or dissimilar joints between carbon or low alloy steels and 14 % Mn Hadfield steels. Carbon level has a relative low influence on the final hardness at room temperature. High Manganese steels should not be exposed over long time intervals to temperatures exceeding 350 °C in order to avoid any embrittlement by carbide precipitation.

#### Main characteristics

Usual Austenitic & Martensitic single microstructures used in overlay welding.

- Work hardenable
- Fairly resistant to rusting
- Not magnetic in as cast state
- Not hardenable by heat treatment
- Strongly resistant to impacts
- Cannot be flame cut
- Not prone to crack propagation
- Moderately resistant to abrasion most over in the work hardened state

## Metallography structures

### 2. Martensitic

#### Field of use & properties comments

3 subfamilies of martensitic alloys are existing: unalloyed (mainly alloyed with C & Cr), medium alloyed (alloyed with C, Cr < 11 %, Mo, W, V, Nb) & stainless grades (alloyed with min. 12 % Cr). The martensite is a microstructure out of equilibrium, obtained by rapid cooling, the faster the cooling rate, the harder the microstructure. Low carbon, unalloyed martensitic alloys are primarily used for building-up to original dimensions or for buffering prior to hardfacing with harder materials. Overlay welding with martensitic alloys (as substrate or consumable) generally require preheating ( $\geq 150 - 350$  °C depending on chemistry and thickness concerned) in order to avoid cold cracking due inappropriate cooling rate. Medium alloyed martensitics thanks to their good tempering resistance may be used to repair welding on cold & hot working tool steels up to 500 – 550 °C.

Stainless martensitic alloys are fairly resisting to thermal shock, to wet corrosion and show a good behaviour face to adhesion and hot oxidation that makes them appreciated for overlays on cast iron and steel mill hot rollers and for Sulphur bearing fumes exhaust systems. These alloys don't suit for joining purposes nor used for overlaying austenitic grades.

### Main characteristics (2. Martensitic)

Usual Austenitic & Martensitic single microstructures used in overlay welding

- Generally good resistance against impacts up to 0.5 % C
- Quite high resistance against compressive stresses
- High response to heat treating
- Particular good behaviour to adhesion wear (metal to metal sliding wear)
- Prone to crack propagation
- Low resistant to rusting with exception for martensitic stainless grades
- Resistant to hot oxidation up to 800 °C and to hot corrosion for stainless grades

## Metallography structures

### 3. Complex carbide microstructure with austenitic or martensitic iron matrix

#### Field of use & properties comments

Alloys of this family perform very well when abrasion is concerned thanks to their variable proportions of widely dispersed carbides. Therefore most of these alloys contain as main alloying elements both carbon and chromium. Low carbon (1.5 – 3%) favours small carbides quantities related to the matrix so they exhibit good abrasion resistance combined with a good toughness properties making them capable to make a good compromise when both shocks and abrasion are present.

Increased level of carbon (up to 6 – 7%), allow to boost the carbide number and sizes while the matrix progressively loses its toughness. As consequence of this, relief check cracks appear more frequently and are closer from each other's. With a few exceptions requiring specific procedures, it is generally preferred to use these alloys on substrates buffered with austenitic layers avoiding check cracks to move to the base material. The risk of spalling associated with check cracks and high hardness imposes to minimise the number of layers to 3 or 4. Combination of large and small carbides sizes allow to extend the abrasion wear resistance to fine abrasive particles.

#### Main characteristics

- Highly resistant to abrasion under low & high compressive stresses.
- Moderate to low resistance to impacts
- Fairly resistant to corrosion
- Good resistance to heat
- Only machinable by grinding
- May develop relief check cracks
- Cannot be flame cut

# Welding positions according to EN ISO 6947 und ASME code, section IX

## Butt welds

**PA** ASME: 1G

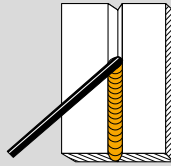
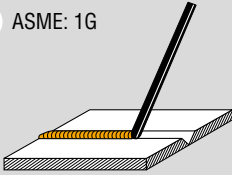

**PF** ASME: 3Gu

**PG** ASME: 3Gd

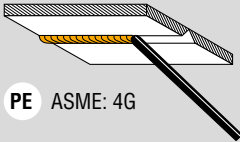
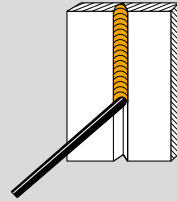

**PE** ASME: 4G

**PC** ASME: 2G

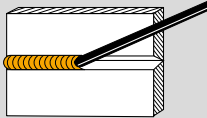

**PC** Pipe: fixed vertical  
Pipe axis: fixed vertical  
ASME: 2G

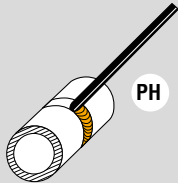
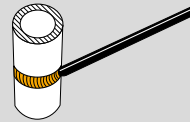

**PH** Pipe: fixed horizontal  
Pipe axis: fixed horizontal  
ASME: 5Gu

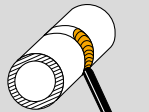

**PJ** Pipe: fixed horizontal  
Pipe axis: fixed horizontal  
ASME: 5Gd

**PA** Pipe: rotating horizontal  
Pipe axis: rotating horizontal  
ASME: 1G

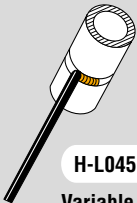
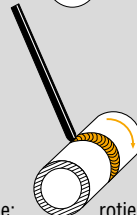

**H-L045**  
Variable axis  
Pipe: fixed inclined (e.g. 45°)  
Pipe axis: fixed inclined (e.g. 45°)  
ASME: 6Gu

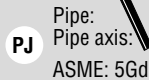

**J-L045**

Variable axis  
Pipe: fixed inclined (e.g. 45°)  
Pipe axis: fixed inclined (e.g. 45°)  
ASME: 6Gd



# Welding positions according to EN ISO 6947 und ASME code, section IX

## Fillets welds

**PA** ASME: 1F

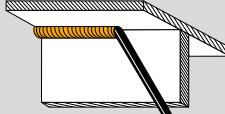
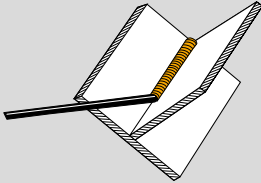

**PD** ASME: 4F

**PG** ASME: 3Fd

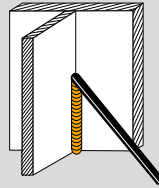
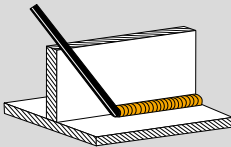
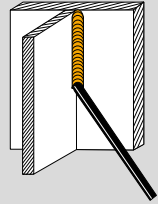

**PF** ASME: 3Fu

**PB** ASME: 2F

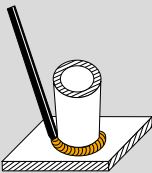

Pipe: fixed vertical  
Pipe axis: ASME: 2F

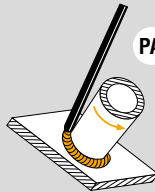

**PA** Pipe: rotated inclined  
Pipe axis: ASME: 1FR

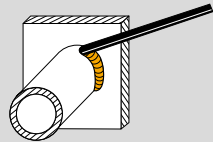

**PH** Pipe: fixed horizontal  
Pipe axis: ASME: 5Fu

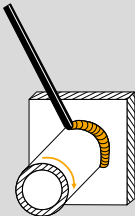

**PB** Pipe: rotated horizontal  
Pipe axis: ASME: 2FR

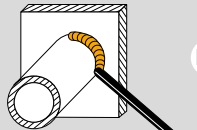

**PJ** Pipe: fixed horizontal  
Pipe axis: ASME: 4Fd

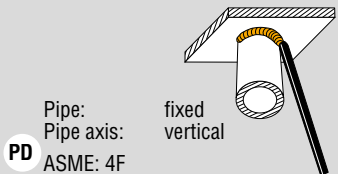

**PD** Pipe: fixed vertical  
Pipe axis: ASME: 4F

## Alphabetical product index

<b>SMAW – covered electrodes</b>	<b>16</b>	UTP 2133 Mn	39
UTP 068 HH	36	UTP 2535 Nb	40
UTP 5 D	49	UTP 3545 Nb	41
UTP 8	50	UTP 4225	42
UTP 32	56	UTP 6170 Co	43
UTP 34 N	61	UTP 6222 Mo	44
UTP 39	57	UTP 6225 Al	45
UTP 63	23	UTP 6635	31
UTP 65	24	UTP 6824 LC	32
UTP 65 D	25	UTP 7000	74
UTP 67 S	62	UTP 7008	75
UTP 68	26	UTP 7010	76
UTP 68 H	27	UTP 7015	46
UTP 68 LC	28	UTP 7015 Mo	47
UTP 68 Mo	29	UTP 7100	77
UTP 68 MoLC	30	UTP 7200	78
UTP 73 G 2	63	UTP BMC	79
UTP 73 G 3	64	UTP CELSIT 701	80
UTP 73 G 4	65	UTP CELSIT 706	81
UTP 75	66	UTP CELSIT 712	82
UTP 80 M	34	UTP CELSIT 721	83
UTP 80 Ni	35	UTP CHRONOS	84
UTP 83 FN	51	UTP DUR 250	85
UTP 85 FN	52	UTP DUR 350	86
UTP 86 FN	53	UTP DUR 600	87
UTP 86 FN-5	54	UTP DUR 650 Kb	88
UTP 320	58	UTP HydroCav	89
UTP 387	59	UTP LEDURIT 61	90
UTP 611	19	UTP LEDURIT 65	91
UTP 613 Kb	20	<b>GTAW – TIG rods</b>	<b>92</b>
UTP 614 Kb	21	UTP A 068 HH	109
UTP 665	67	UTP A 34	124
UTP 670	68	UTP A 34 N	125
UTP 673	69	UTP A 38	126
UTP 690	70	UTP A 63	97
UTP 700	71	UTP A 68	98
UTP 702	72	UTP A 68 LC	99
UTP 750	73	UTP A 68 Mo	100
UTP 759 Kb	37	UTP A 68 MoLC	101
UTP 776 Kb	38	UTP A 73 G 2	134

## Alphabetical product index

UTP A 73 G 3	135	UTP A 63	154
UTP A 73 G 4	136	UTP A 68	155
UTP A 80 M	107	UTP A 68 LC	156
UTP A 80 Ni	108	UTP A 68 Mo	157
UTP A 381	127	UTP A 68 MoLC	158
UTP A 384	128	UTP A 73 G 2	193
UTP A 387	129	UTP A 73 G 3	194
UTP A 641	95	UTP A 73 G 4	195
UTP A 651	102	UTP A 80 M	164
UTP A 673	137	UTP A 80 Ni	165
UTP A 696	138	UTP A 118	149
UTP A 702	139	UTP A 119	150
UTP A 722	110	UTP A 381	184
UTP A 759	111	UTP A 384	185
UTP A 776	112	UTP A 387	186
UTP A 2133 Mn	113	UTP A 641	151
UTP A 2535 Nb	114	UTP A 643	152
UTP A 3422	130	UTP A 651	159
UTP A 3422 MR	131	UTP A 661	196
UTP A 3444	132	UTP A 702	197
UTP A 3545 Nb	115	UTP A 759	167
UTP A 4221	116	UTP A 776	168
UTP A 6170 Co	117	UTP A 786	169
UTP A 6222 Mo	118	UTP A 2133 Mn	170
UTP A 6225 Al	119	UTP A 2535 Nb	171
UTP A 6635	103	UTP A 3422	187
UTP A 6808 Mo	104	UTP A 3444	188
UTP A 6824 LC	105	UTP A 3545 Nb	172
UTP A 8036 S	120	UTP A 4221	173
UTP A 8051 Ti	122	UTP A 5519 Co	198
UTP A CELSIT 706 V	142	UTP A 6170 Co	199
UTP A Celsit 712 SN	143	UTP A 6222 Mo	174
UTP A CELSIT 721	144	UTP A 6222 Mo-3	175
UTP A DUR 600	140	UTP A 6225 Al	176
<b>GMAW – solid wires</b>	<b>146</b>	UTP A 6635	160
UTP A 068 HH	166	UTP A 6808 Mo	161
UTP A 34	181	UTP A 6824 LC	162
UTP A 34 N	182	UTP A 8036 S	177
UTP A 34 N	192	UTP A 8051 Ti	179
UTP A 38	183	UTP A DUR 250	200

## Alphabetical product index

UTP A DUR 350	201	SK D11-G	254
UTP A DUR 600	202	SK D12-G	255
UTP A DUR 650	203	SK D12S-G	256
<b>FCAW-G – gas shielded cored wires</b>	<b>204</b>	SK D15-G	257
SK 250-G	228	SK D16-G	258
SK 255-G	242	SK D20-G	259
SK 258-G	229	SK D33-G	260
SK 258L-G	230	SK D35-G	261
SK 258 NbC-G	243	SK D37-G	262
SK 258 TiC-G	231	SK D37S-G	263
SK 300-G	232	SK D40-G	264
SK 307-G	294	SK D40S-G	265
SK 350-G	233	SK D52-G	266
SK 356-G	295	SK D250-G	267
SK 402-G	296	SK FNM-G	284
SK 410 C-G	297	SK FNM4-G	285
SK 420 Mo-G	298	SK HYDROCAV	248
SK 430-G	299	SK STELKAY 1-G	270
SK 430 Mo-G	300	SK STELKAY 6 A-G	272
SK 450-G	234	SK STELKAY 6-G	271
SK 500-G	235	SK STELKAY 6 L-G	273
SK 519-G	301	SK STELKAY 6 T-G	274
SK 600C-G	237	SK STELKAY 12-G	275
SK 600-G	236	SK STELKAY 21-G	276
SK 650-G	238	SK STELKAY 21 L-G	277
SK 741-G	302	SK STELKAY 21 T-G	278
SK 768-G	303	SK STELKAY 25-G	279
SK 797-G	224	SK TOOL ALLOY C-G	286
SK 900 Ni-G	282	SK TOOL ALLOY Co-G	287
SK 900 Ni RTC-G	283	SK U 520 Co-G	288
SK A45-G	244	SK U 521-G	289
SK A68-G	239	UTP AF 068 HH	290
SK A70-O/G	245	UTP AF 68 LC	209
SK ABRA-MAX O/G	246	UTP AF 68 LC PW	210
SK ANTINIT DUR 290	304	UTP AF 68 MoLC	211
SK ANTINIT DUR 500	305	UTP AF 68 MoLC PW	212
SK AP-G	225	UTP AF 155	207
SK CuAl10-G	247	UTP AF 6222 MoPW	213
SK D8-G	252	UTP AF 6808 Mo	214
SK D8S-G	253	UTP AF 6808 Mo PW	216

## Alphabetical product index

UTP AF 6824 LC	218	SK 420-0	383
UTP AF 6824 LC PW	220	SK 430-0	384
UTP AF ROBOTIC 351 B	308	SK 460-0	360
UTP AF ROBOTIC 352	309	SK 624-0	327
UTP AF ROBOTIC 405	310	SK 714 N-0	385
UTP AF ROBOTIC 405 B	311	SK 741-0	386
UTP AF ROBOTIC 453	312	SK 795-0	340
UTP AF ROBOTIC 503	313	SK 820-0	361
UTP AF ROBOTIC 600	314	SK 866-0	362
UTP AF ROBOTIC 603	315	SK 867-0	363
UTP AF ROBOTIC 606	316	SK 867WP-0	364
UTP AF ROBOTIC 606 B	317	SK 900-0	365
UTP AF ROBOTIC 6011	318	SK A12-0	341
<b>FCAW-0 – open arc cored wires</b>	<b>320</b>	SK A39-0	366
SK 14 Mn-0	324	SK A43-0	367
SK 162-0	350	SK A43-0B	368
SK 162 WP-0	351	SK A43WP-0	369
SK 218-0	325	SK A44-0	370
SK 232-0	332	SK A45-0	371
SK 240-0	352	SK A45W-0	372
SK 242-0	333	SK A46-0	373
SK 252-0	334	SK A64-0	374
SK 255 Mo-0	353	SK ABRA-MAX O/G	375
SK 255-0	354	SK AP-0	328
SK 256 Mn-0	355	SK AP-OSP	329
SK 256-0	356	SK BU-C1	342
SK 258L-0	336	SK BU-0	343
SK 258 NbC-0	357	SK CrMo21Ni-0	344
SK 258-0	335	SK SOUDOCORE S8-0	345
SK 258 TIC-0	337	<b>SAW – solid wires and fluxes</b>	<b>388</b>
SK 260 NbC-0	358	UTP UP 068 HH	400
SK 299-0	359	UTP UP 73 G 2	391
SK 300-0	338	UTP UP 73 G 3	392
SK 308L-0	378	UTP UP 73 G 4	393
SK 309L-0	379	UTP UP 776	401
SK 313-0	326	UTP UP 6222 Mo	402
SK 370-0	380	UTP UP DUR 250	394
SK 400-0	339	UTP UP DUR 350	395
SK 402-0	381	UTP UP FX 104	404
SK 415-0	382	UTP UP FX 504	405



## Alphabetical product index

UTP UP FX 603	397	SK 825-M	478
UTP UP FX 680	398	SK 830-MF	479
<b>Cladding</b>	<b>406</b>	SK 840-MF	480
RECORD SA	447	SK 848-M	476
RECORD SK	448	SK 850-MF	481
RECORD SR	449	SK 858-M	482
SK 20 CrMo-SA	414	SK 860-MF	483
SK 219-S	410	SK 868-M	484
SK 242-S	415	SK 900-MF	485
SK 255-S	426	<b>Special products</b>	<b>488</b>
SK 258L-SA	417	Phoenix Nautica 20	492
SK 258 NbC-SA	418	SK CUTARC	498
SK 258-SA	416	UTP 5 / Flux 5	494
SK 263-SA	419	UTP 82 AS	490
SK 350-S	420	UTP 82 Ko	491
SK 385-SA	434	UTP 7502	495
SK 402-S	435	UTP A 7550	496
SK 410 NiMo-SA	436	UTP A 7560	497
SK 415-SA	437		
SK 420-SA	438		
SK 430C-SA	439		
SK 430 Mo-SA	440		
SK 461C-SA	441		
SK 461-SA	442		
SK 740 L-SA	443		
SK 742 N-SK	444		
SK A45-S	427		
SK AP-S	411		
SK BU-S	421		
SK CrMo15-SA	422		
SK D35-S	430		
SK SOUDOCORE D-SA	423		
<b>Thermal spraying</b>	<b>466</b>		
SK 235-M	473		
SK 255-M	474		
SK 420-M	475		

All data on our products contained in this welding guide are based upon careful investigation and intensive research. However, we do not assume any liability for their correctness.

We recommend the user to test – on his own responsibility – our products with regard to their special application.

### **Imprint**

Welding guide of voestalpine Böhler Welding Germany GmbH  
Edition October 2016 • Printed in Germany • E 10.16 • 1 000

voestalpine Böhler Welding Germany GmbH  
Elsässer Straße 10  
79189 Bad Krozingen  
Germany  
T. +49 7633 409-01  
F. +49 7633 409-222

voestalpine Böhler Welding Belgium S.A.  
Rue de l'Yser 2  
7180 Seneffe  
Belgium  
T. +32 64 5102-25  
F. +32 64 5102-30





UTP Maintenance  
Global Brand Management  
T. + 49 7633 409-01  
[utp.maintenance@voestalpine.com](mailto:utp.maintenance@voestalpine.com)

**voestalpine**  
ONE STEP AHEAD.